



US00D337101S

United States Patent [19]

[11] Patent Number: **Des. 337,101**

Shie et al.

[45] Date of Patent: **** Jul. 6, 1993**

[54] **NOTEBOOK PERSONAL COMPUTER**

[75] Inventors: **Alen Shie; Yi-Hsin Huang**, both of Taipei, Taiwan

[73] Assignee: **Veridata Electronics Inc.**, Taipei, Taiwan

[**] Term: **14 Years**

[21] Appl. No.: **698,163**

[22] Filed: **May 9, 1991**

[52] U.S. Cl. **D14/106**

[58] Field of Search **D14/100, 101, 106, 113, D14/115, 124-127; D18/1, 7; 235/145 A, 145 R; 340/700, 706; 341/22, 23; 364/708, 709.04; 361/390, 394**

[56] **References Cited**

U.S. PATENT DOCUMENTS

- D. 308,861 6/1990 Tsukada et al. D14/106
- D. 317,442 6/1991 Gintz et al. D14/106
- D. 324,675 3/1992 Iino D14/106

FOREIGN PATENT DOCUMENTS

- 685121 10/1988 Japan D14/106

Primary Examiner—Wallace R. Burke
Assistant Examiner—Freda S. Nunn

Attorney, Agent, or Firm—Finnegan, Henderson, Farabow, Garrett & Dunner

[57] **CLAIM**

The ornamental design for notebook personal computer, as shown and described.

DESCRIPTION

FIG. 1 is a perspective view of notebook personal computer showing my new design;
 FIG. 2 is a front elevational view thereof;
 FIG. 3 is a rear elevational view thereof;
 FIG. 4 is a left side view thereof;
 FIG. 5 is a right side view thereof;
 FIG. 6 is a top plan view thereof;
 FIG. 7 is a bottom plan view thereof;
 FIG. 8 is a perspective view thereof but with the cover being opened;
 FIG. 9 is a front elevational view thereof but with the cover being opened;
 FIG. 10 is a rear elevational view thereof but with the cover being opened;
 FIG. 11 is a left side view thereof but with the cover being opened;
 FIG. 12 is a right side view thereof but with the cover being opened;
 FIG. 13 is a top plan view thereof but with the cover being opened; and,
 FIG. 14 is a bottom plan view thereof but with the cover being opened.

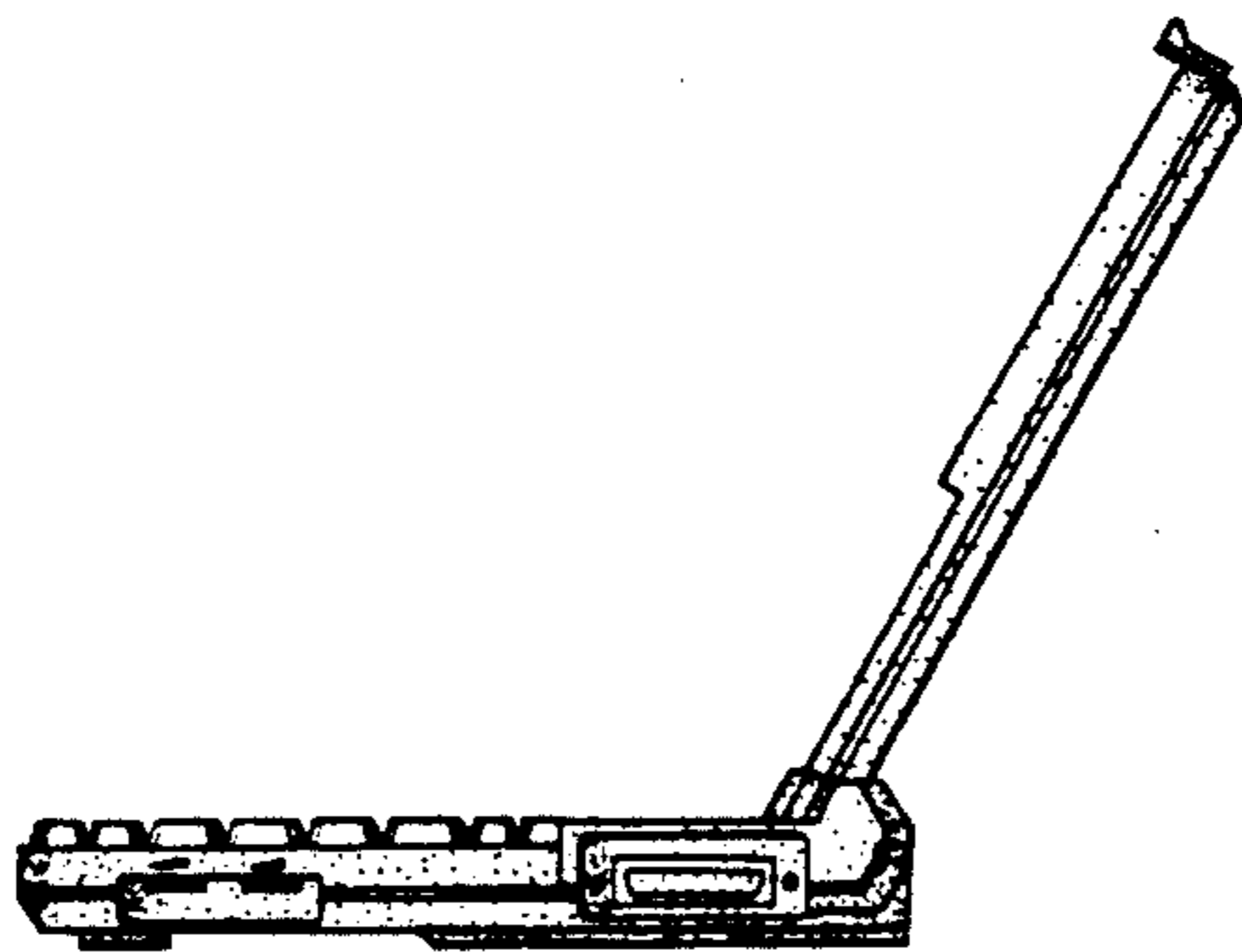
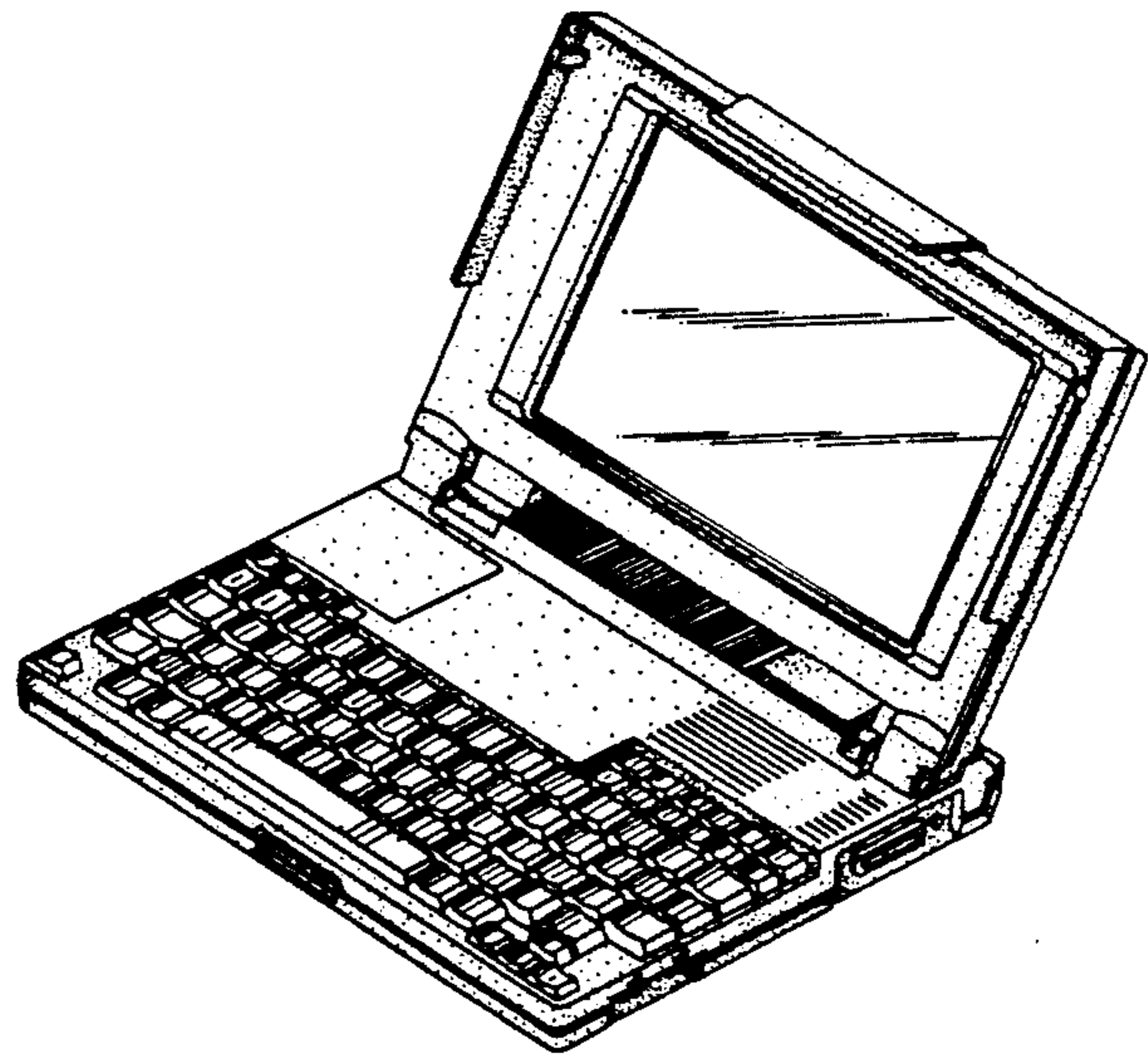
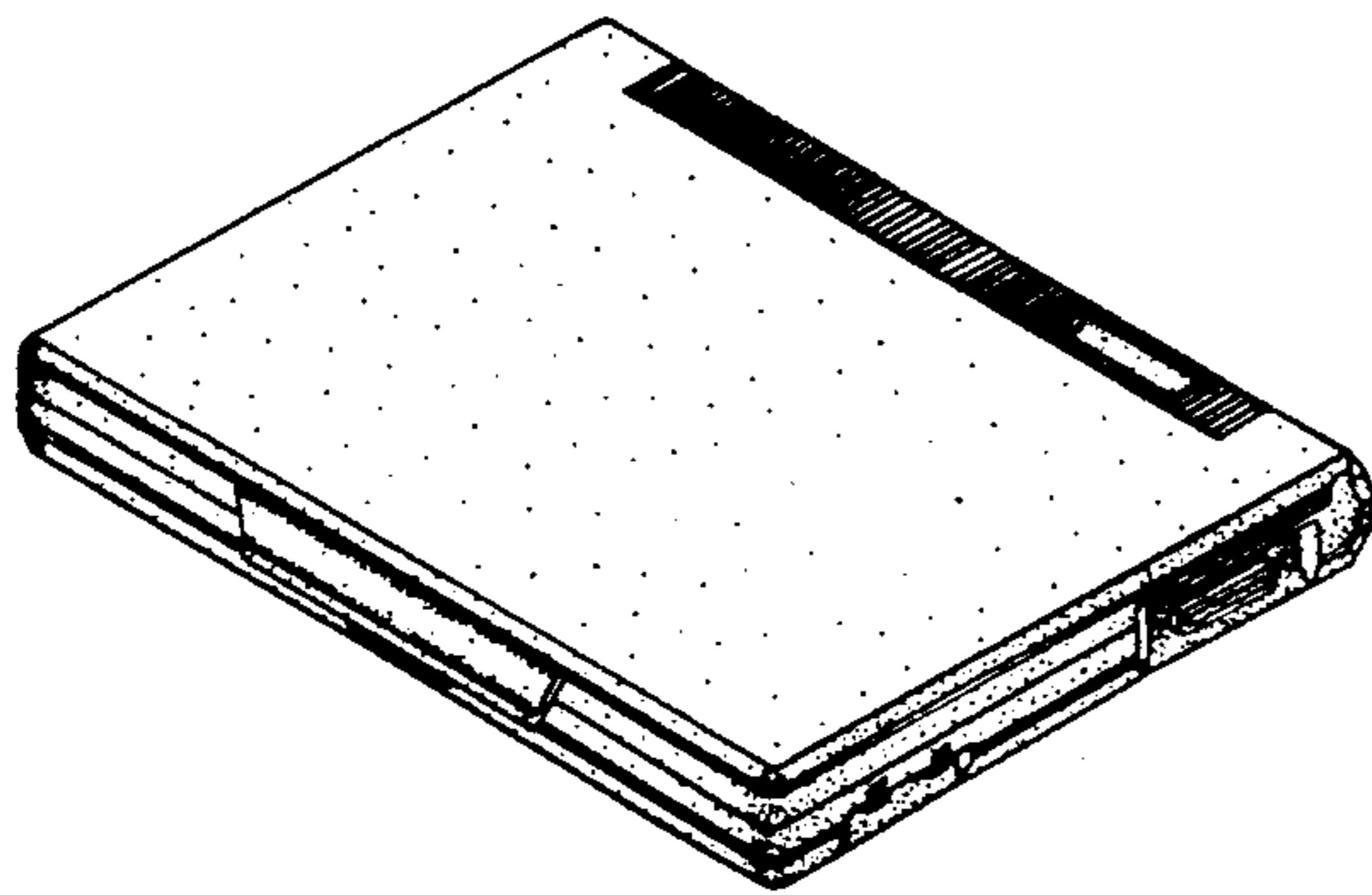

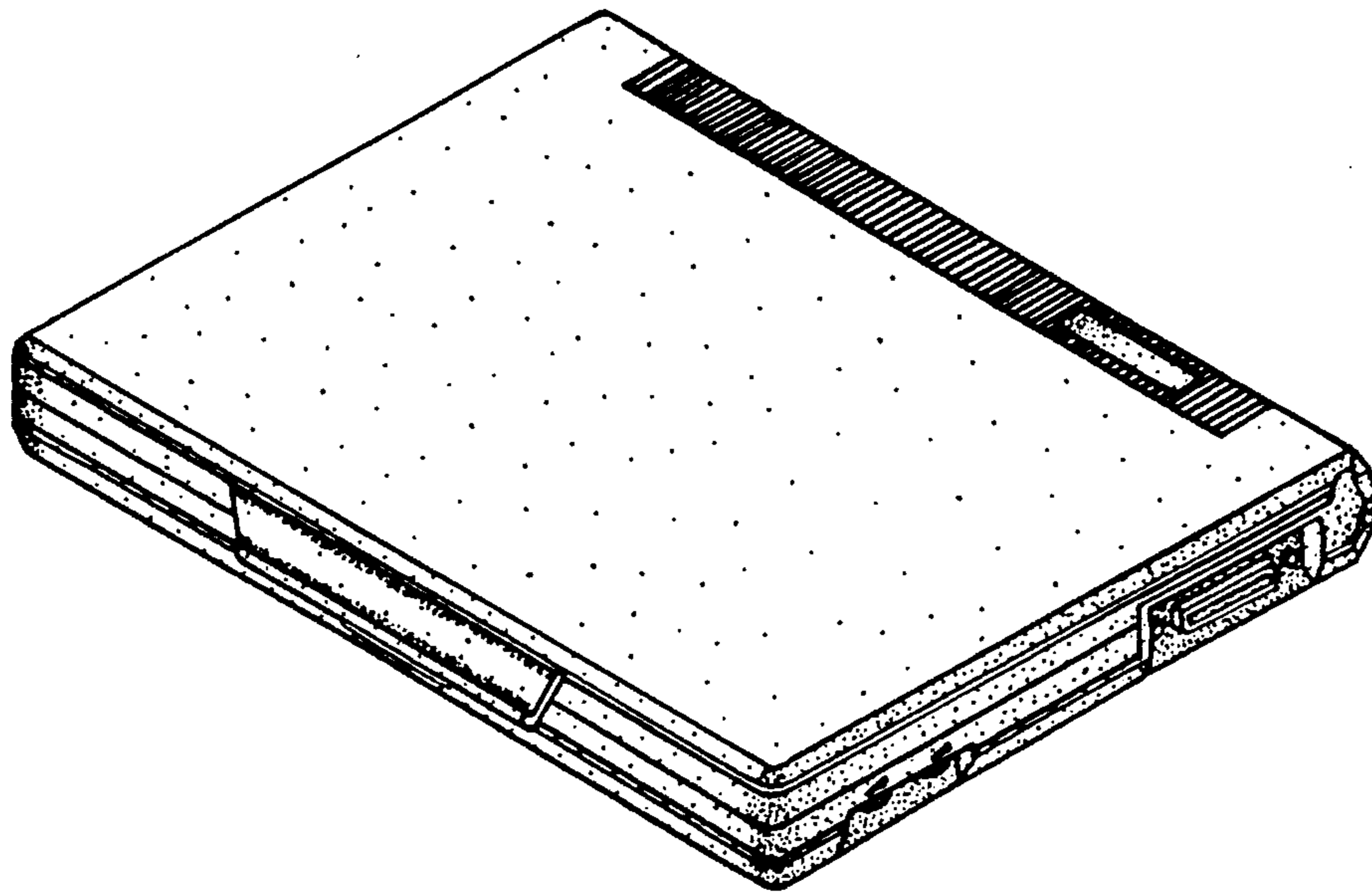

FIG. 1

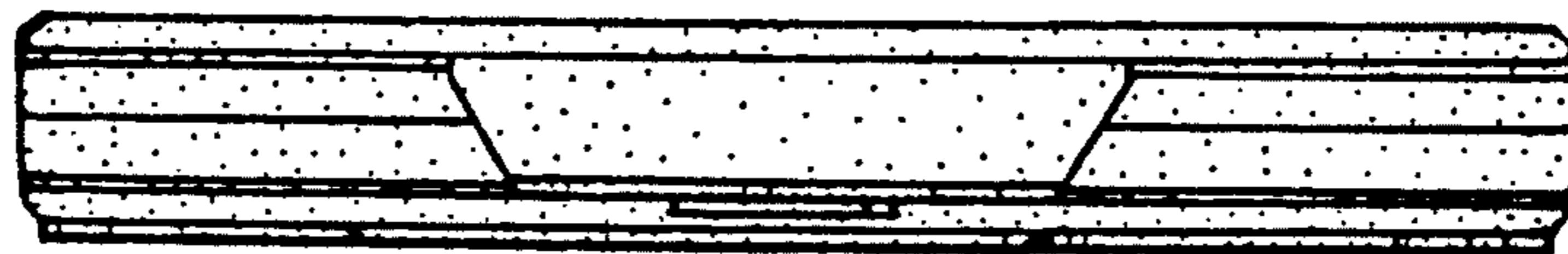

FIG. 2

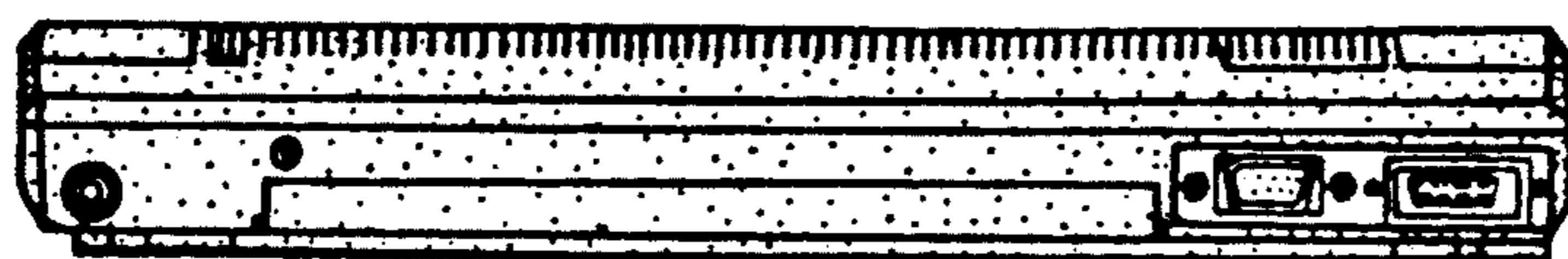

FIG. 3

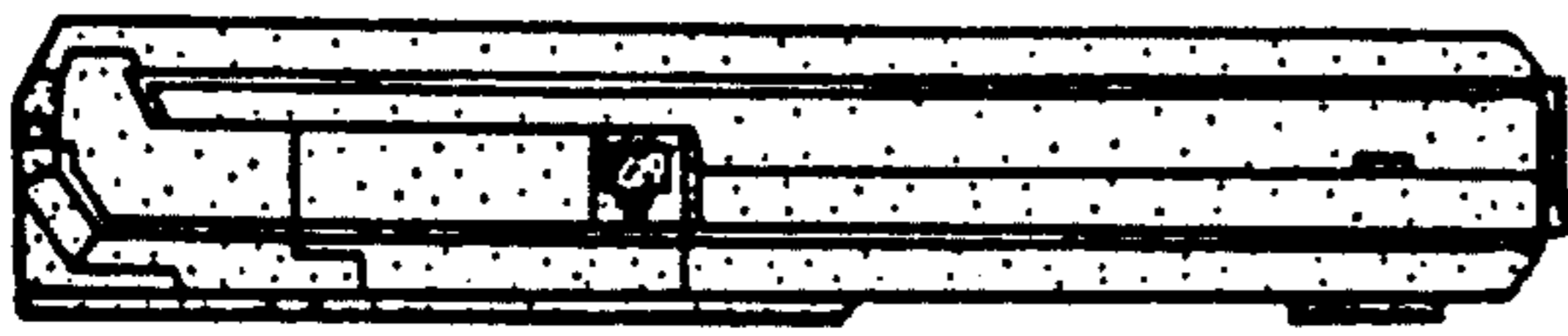

FIG. 4

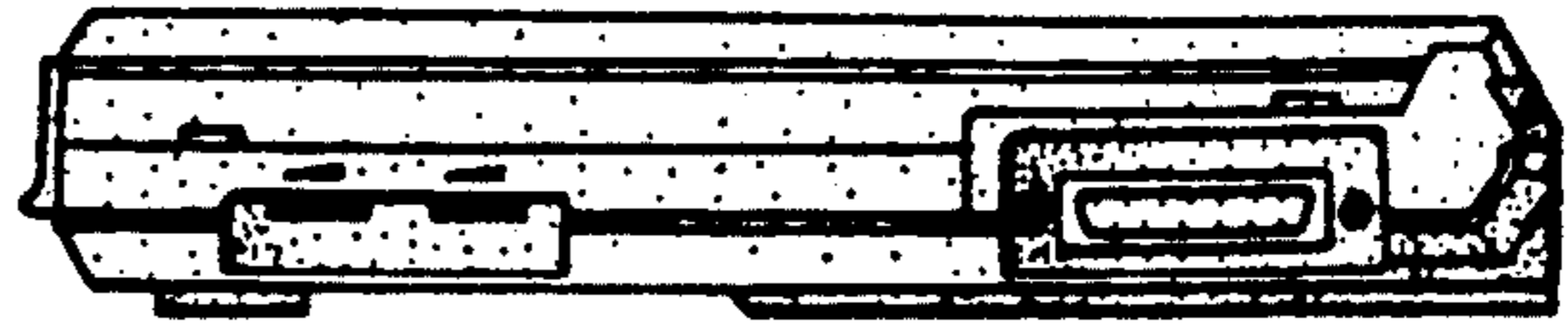

FIG. 5

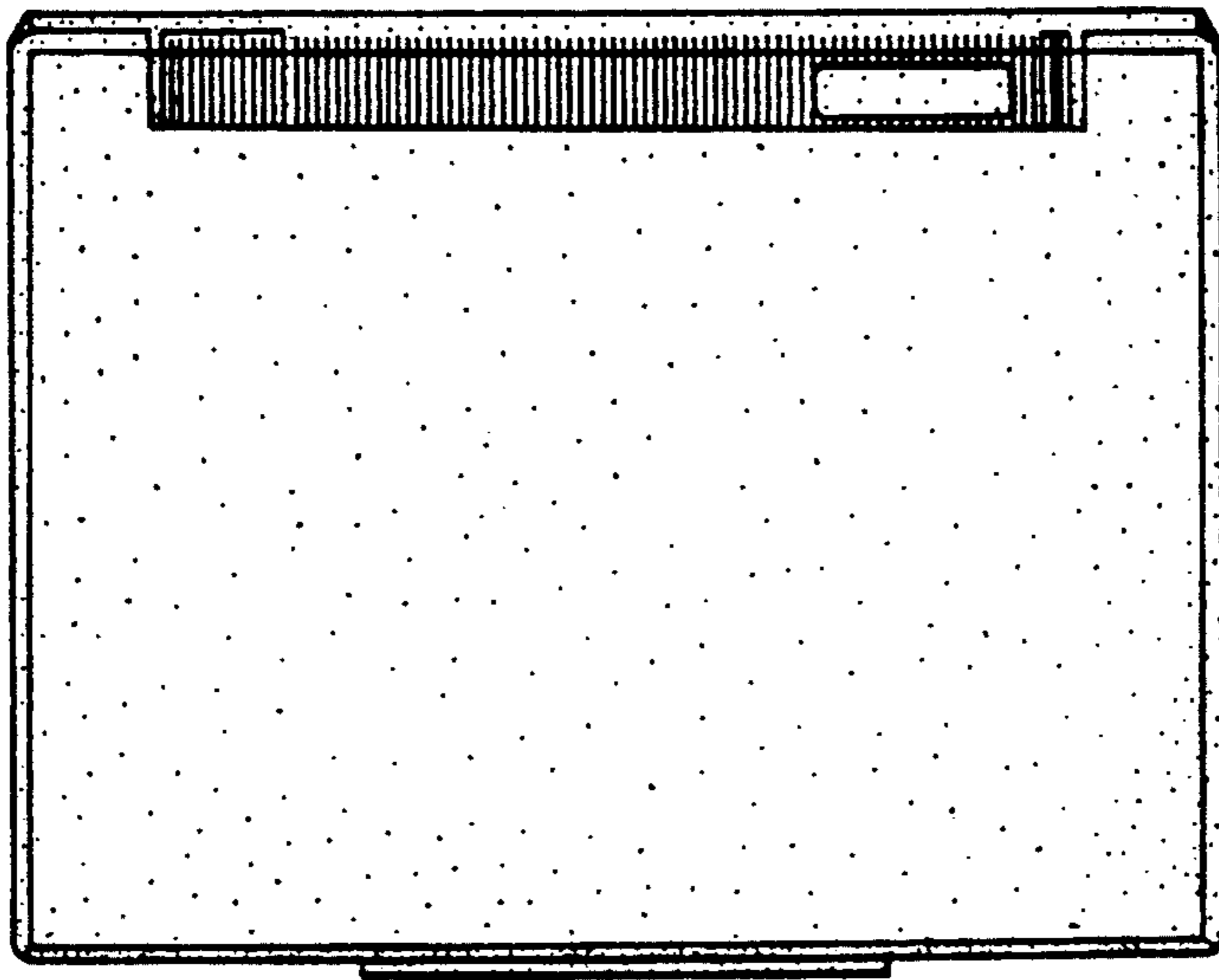

FIG. 6

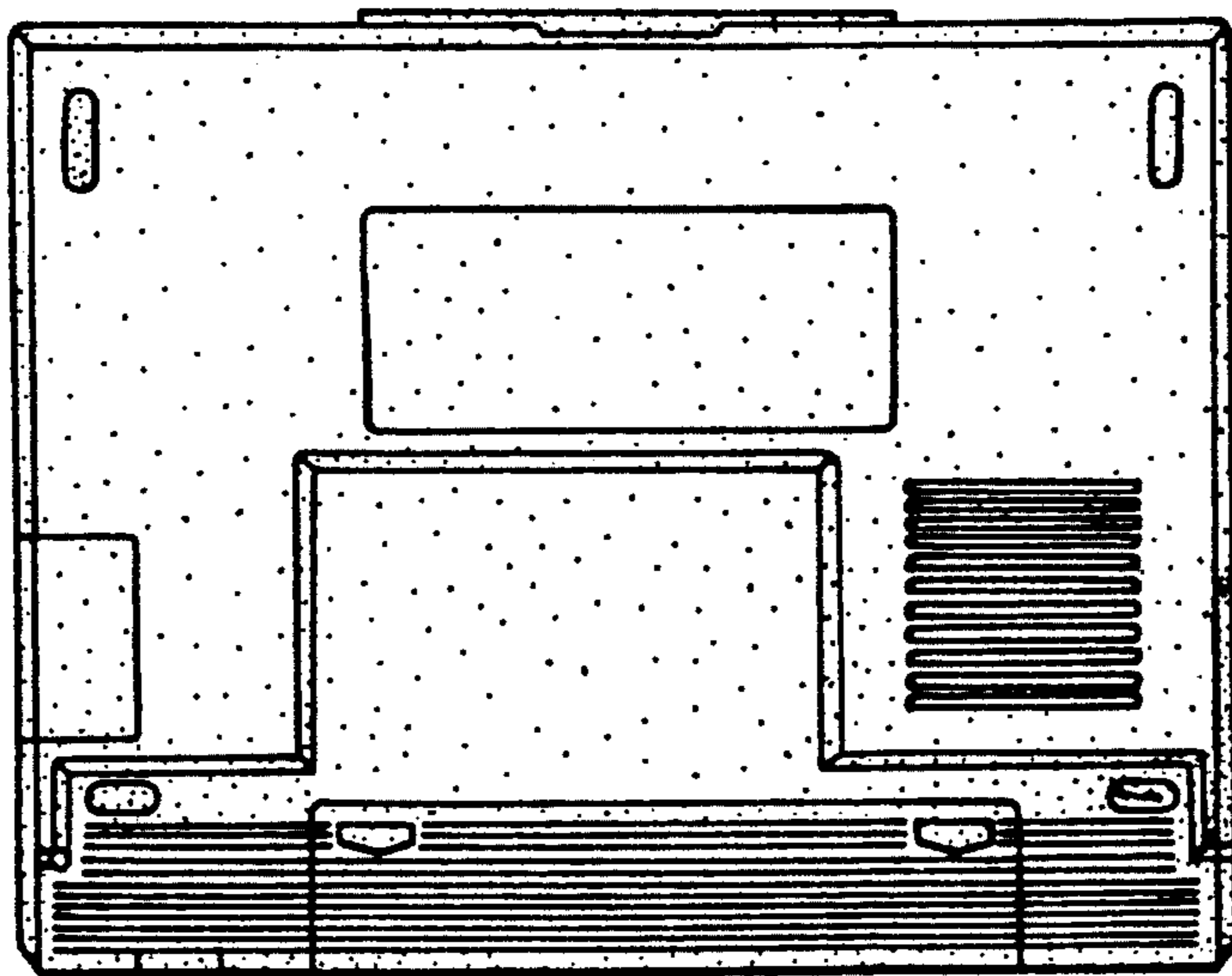

FIG. 7

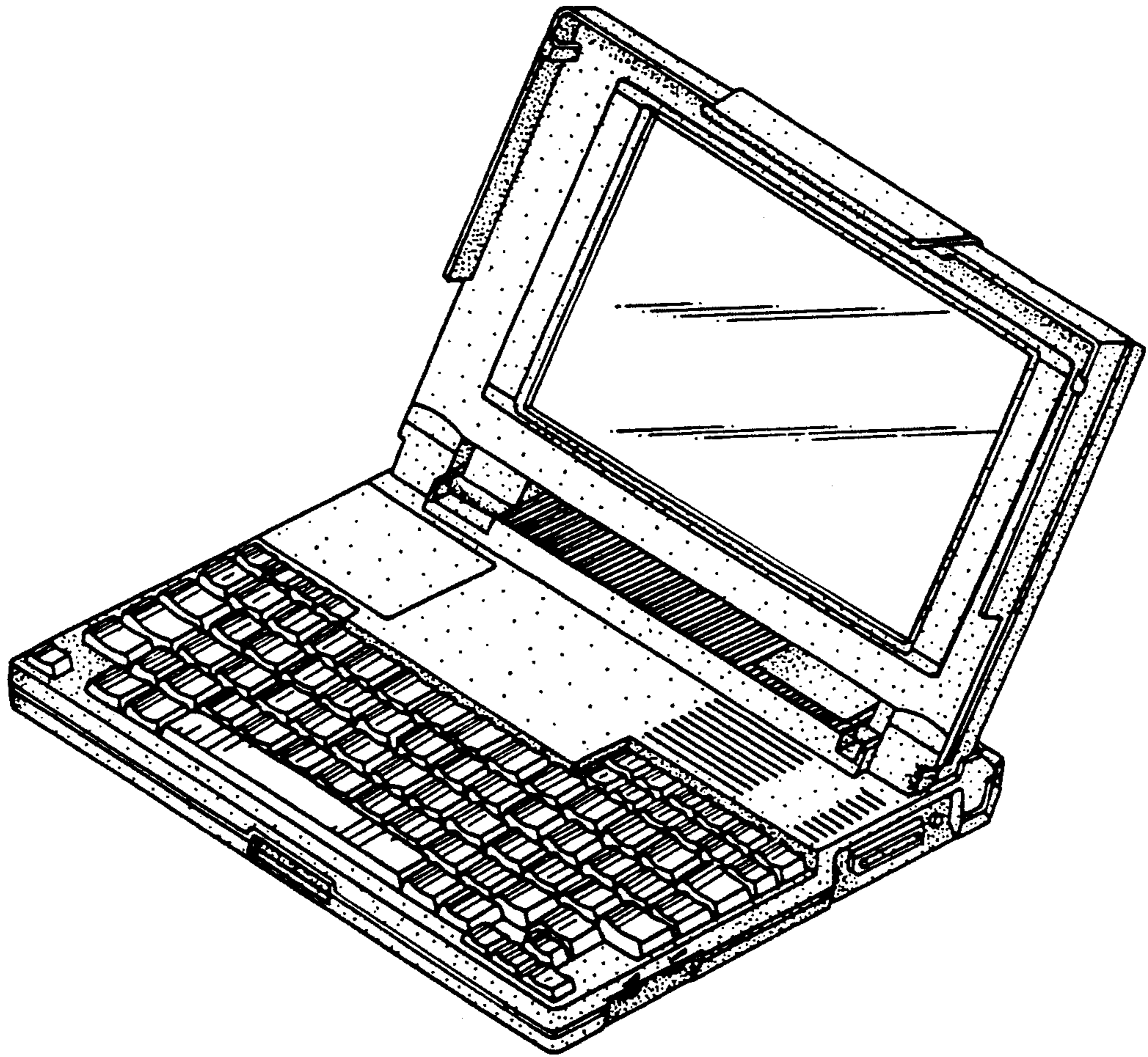

FIG. 8

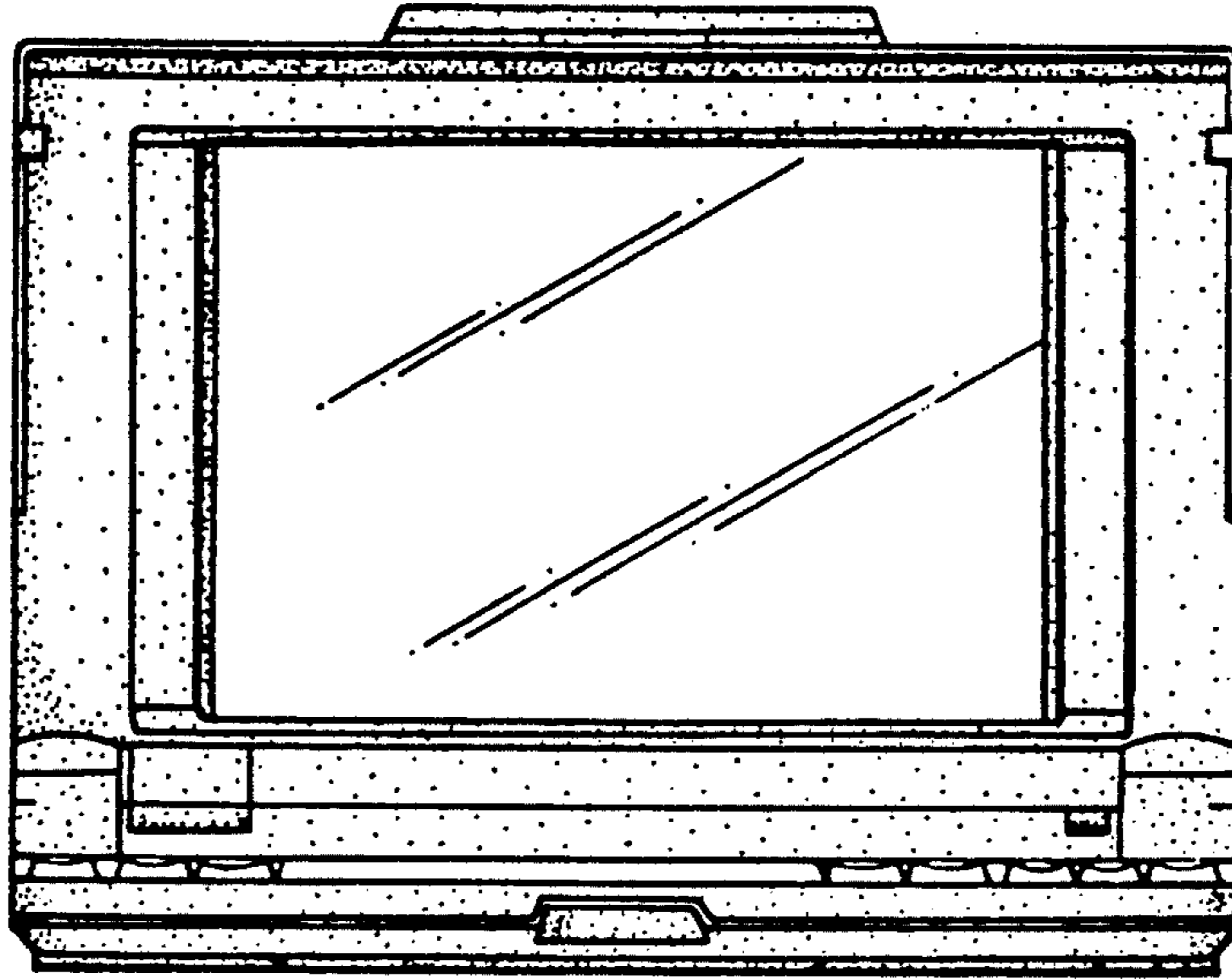

FIG. 9

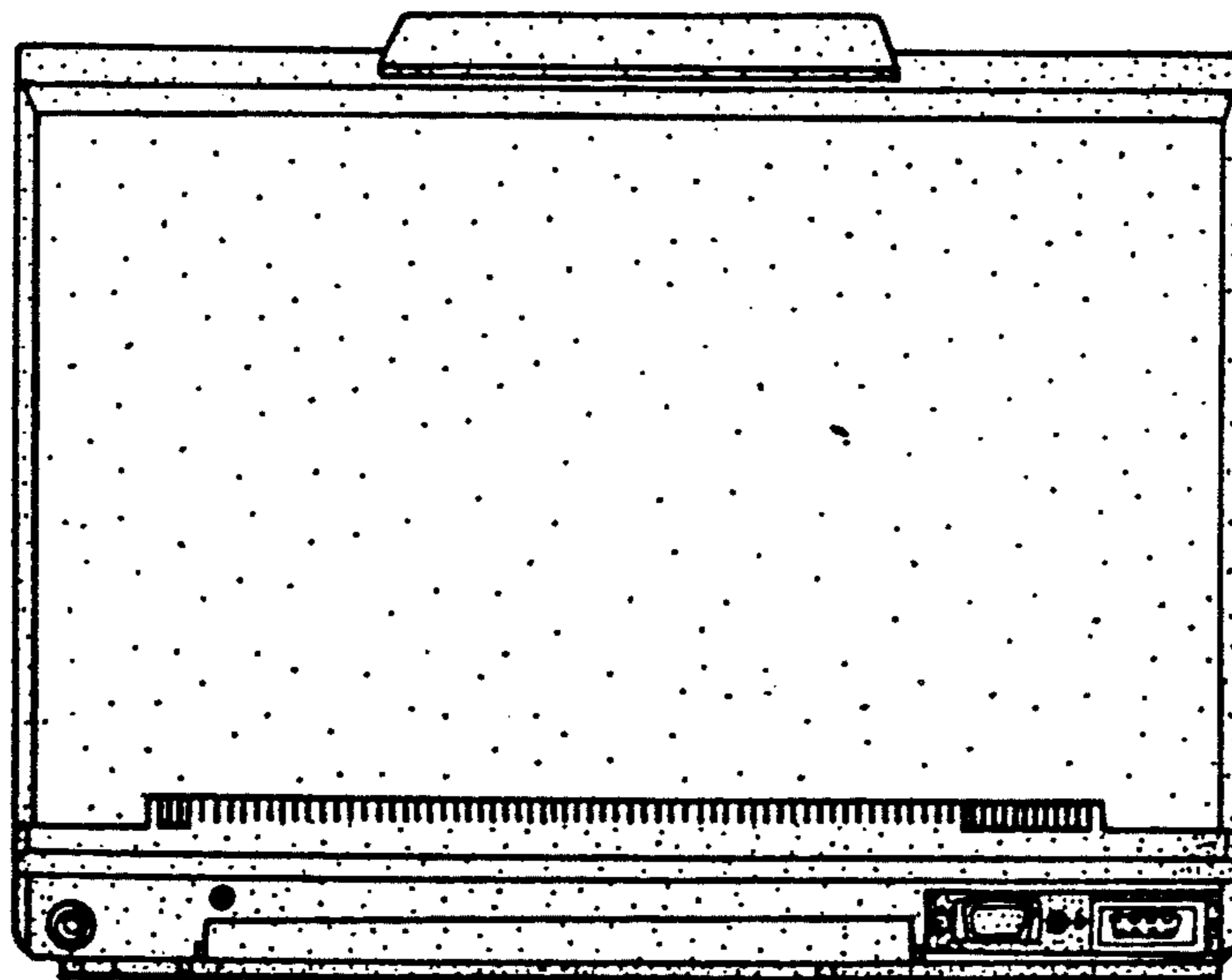

FIG. 10

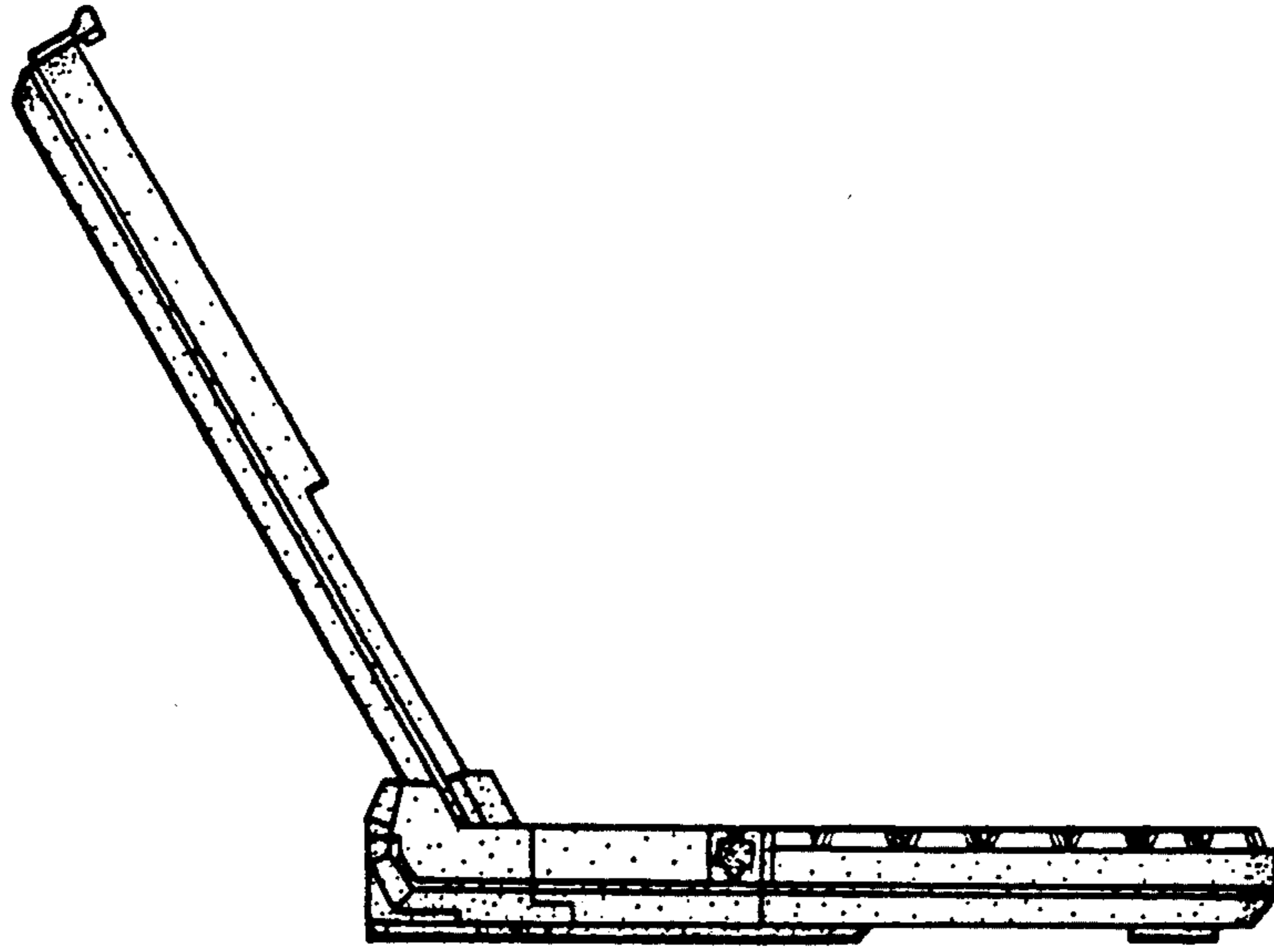

FIG. 11

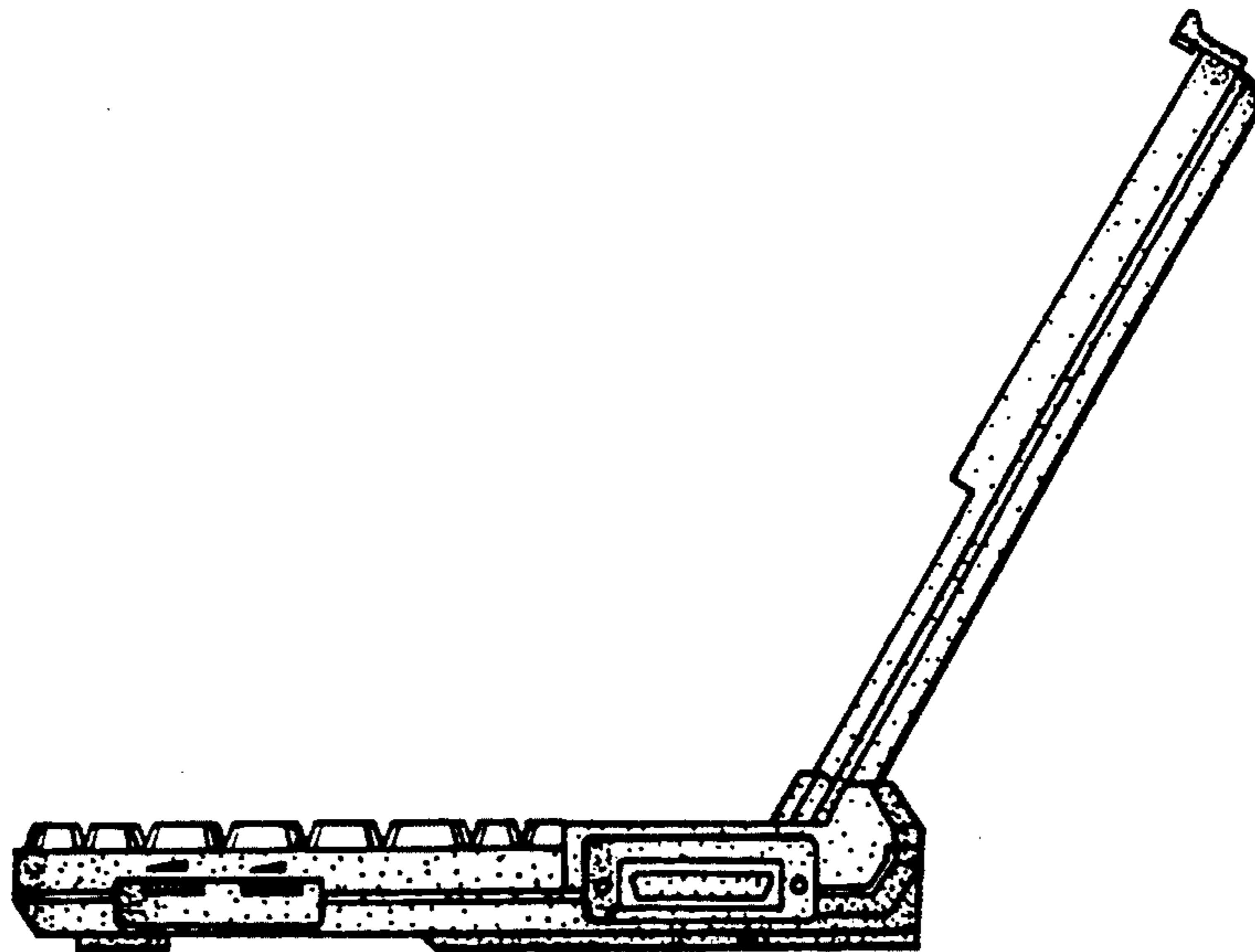

FIG. 12

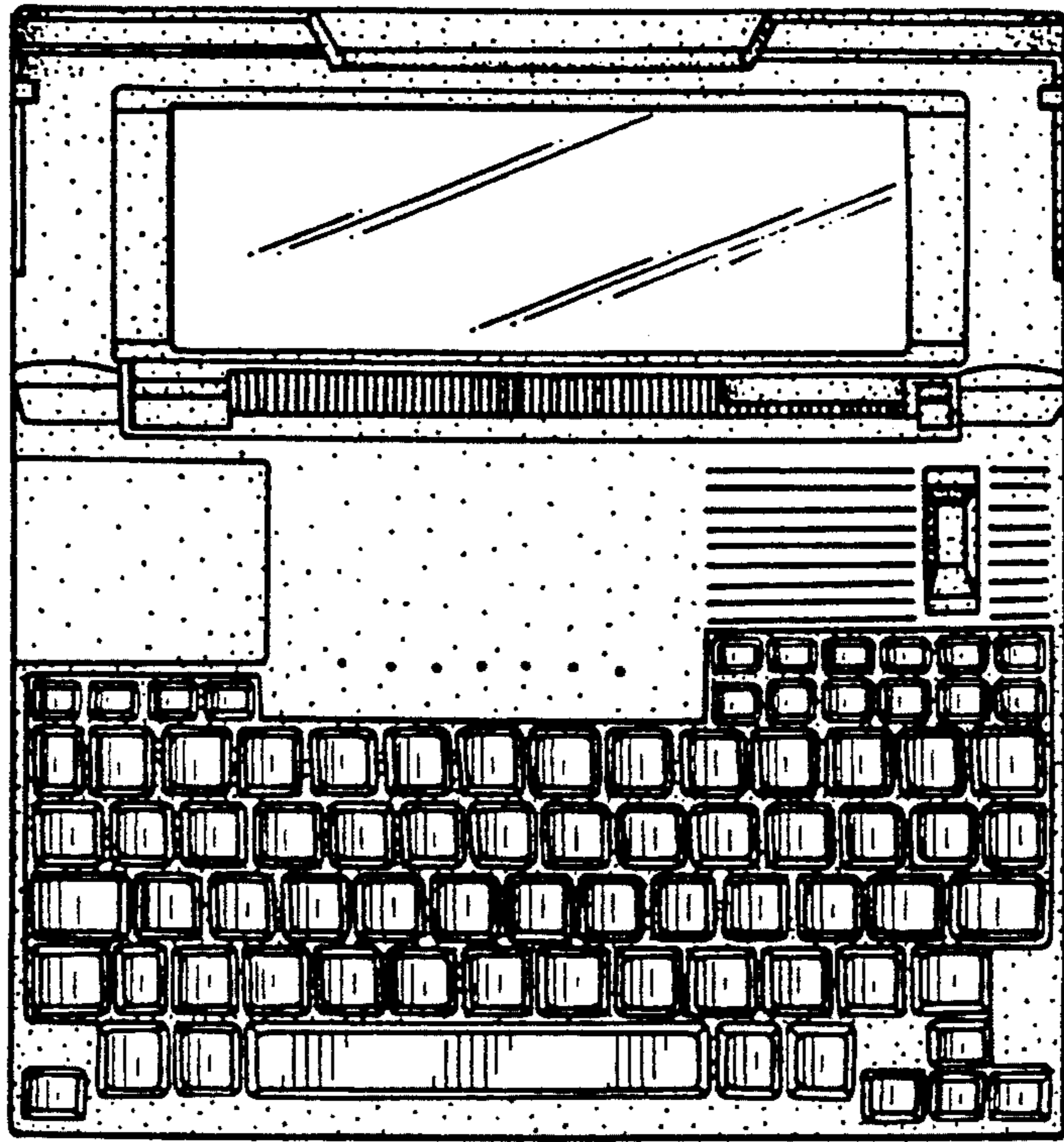

FIG. 13

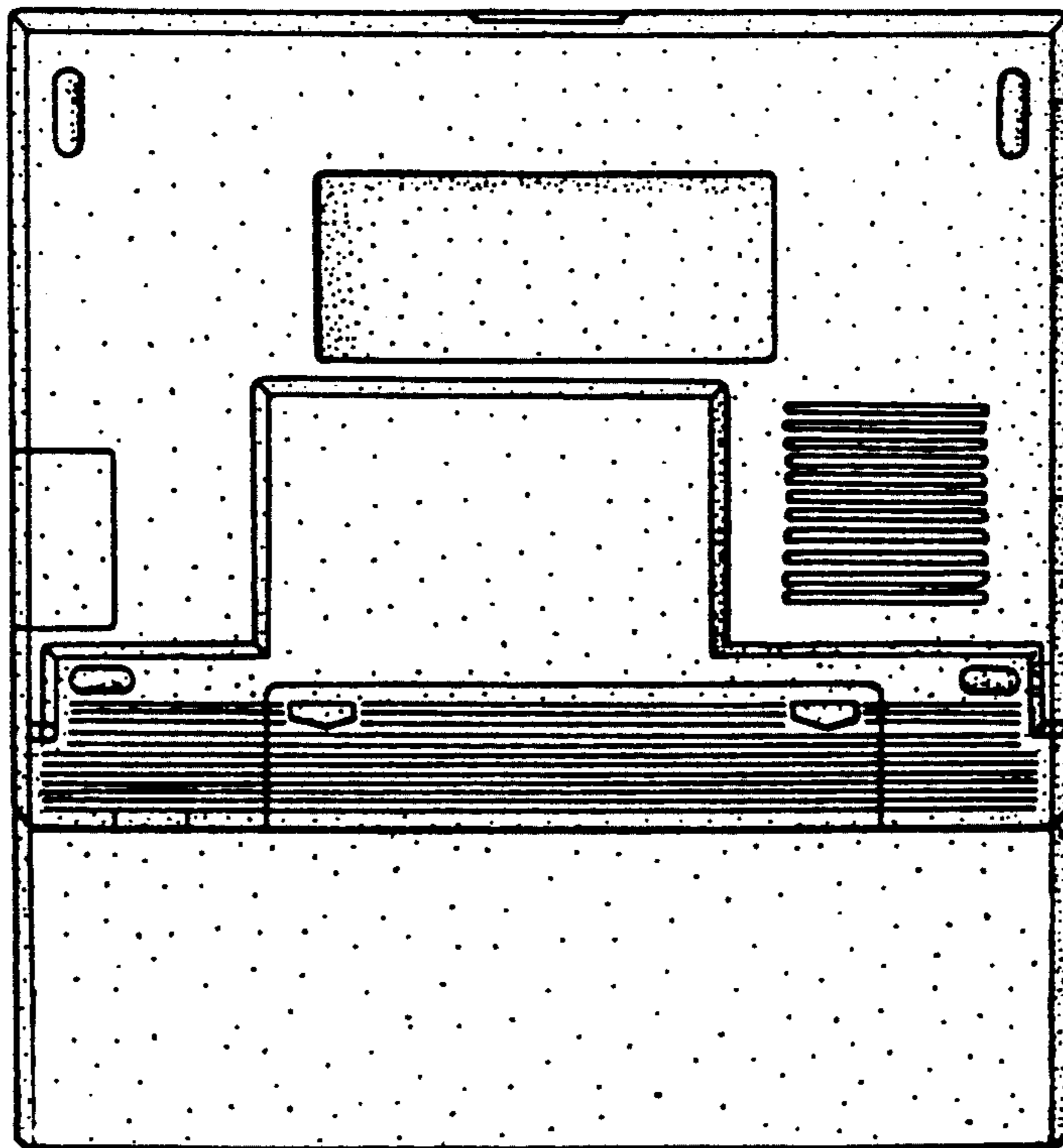

FIG. 14