



US00D336884S

United States Patent [19]

Scheele et al.

[11] Patent Number: **Des. 336,884**

[45] Date of Patent: **** Jun. 29, 1993**

[54] VEHICLE AIR DEFLECTOR

[76] Inventors: **Rick Scheele**, Box 381; **Dennis Nelson**, Box 741, both of Darby, Mont. 59829

[**] Term: **14 Years**

[21] Appl. No.: **699,240**

[22] Filed: **May 13, 1991**

[52] U.S. Cl. **D12/181**

[58] Field of Search **D12/181; 296/180.1, 296/180.2, 91**

[56] References Cited

U.S. PATENT DOCUMENTS

- D. 206,872 2/1967 Borick D12/181
- D. 238,666 2/1976 Herrod D12/181

FOREIGN PATENT DOCUMENTS

0018785 1/1989 Japan 296/180.1

Primary Examiner—James M. Gandy
Attorney, Agent, or Firm—Wells, St. John, Roberts, Gregory & Matkin

[57] CLAIM

The ornamental design for a vehicle air deflector, as shown and described.

DESCRIPTION

FIG. 1 is a rear perspective view of a vehicle air deflector showing our new design;
 FIG. 2 is a front perspective view thereof;
 FIG. 3 is a left-side elevational view thereof, the right side being a mirror image of that shown;
 FIG. 4 is a front elevational view thereof;
 FIG. 5 is a rear elevational view thereof;
 FIG. 6 is a top plan view thereof; and,
 FIG. 7 is a bottom plan view thereof.

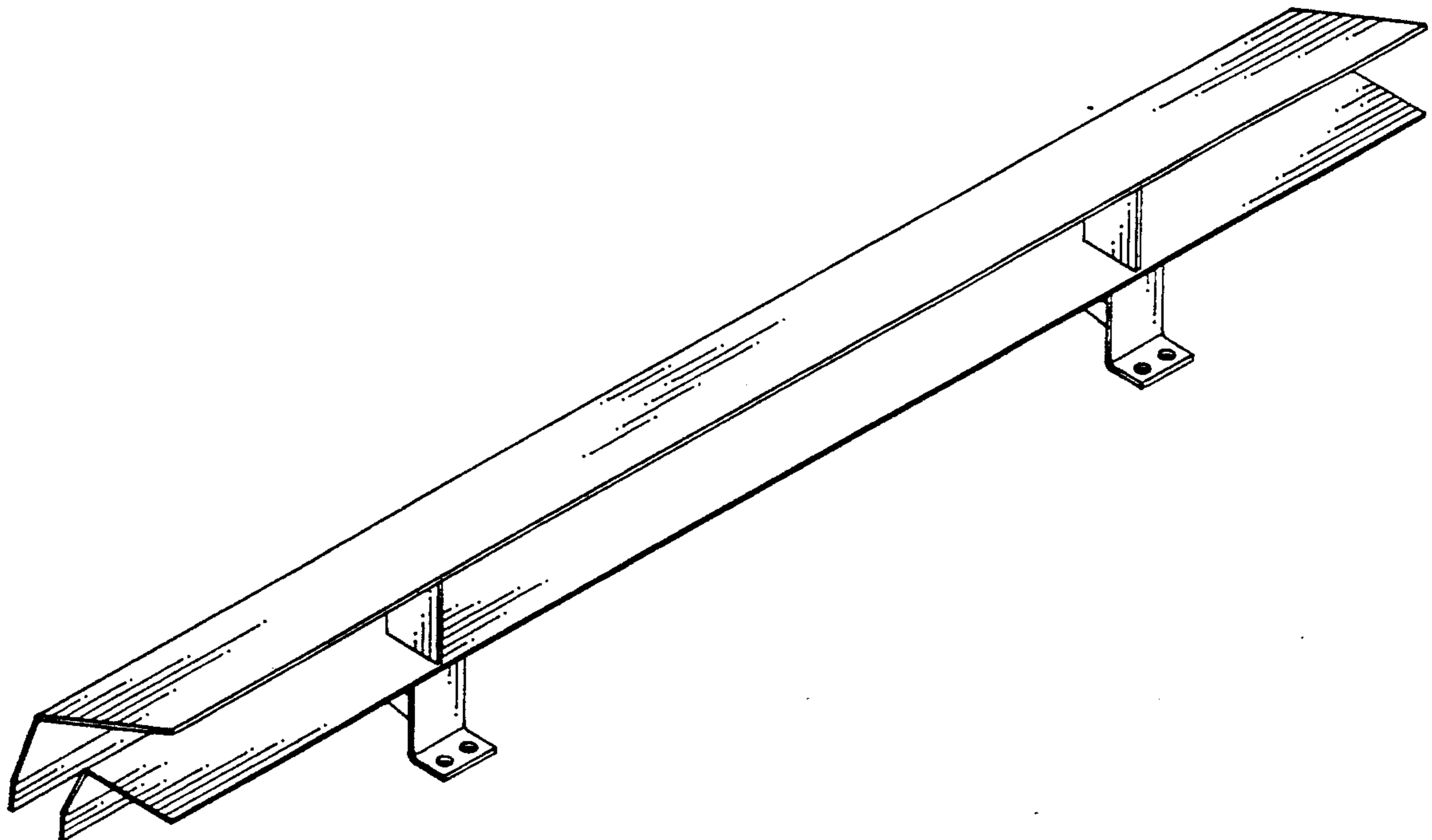

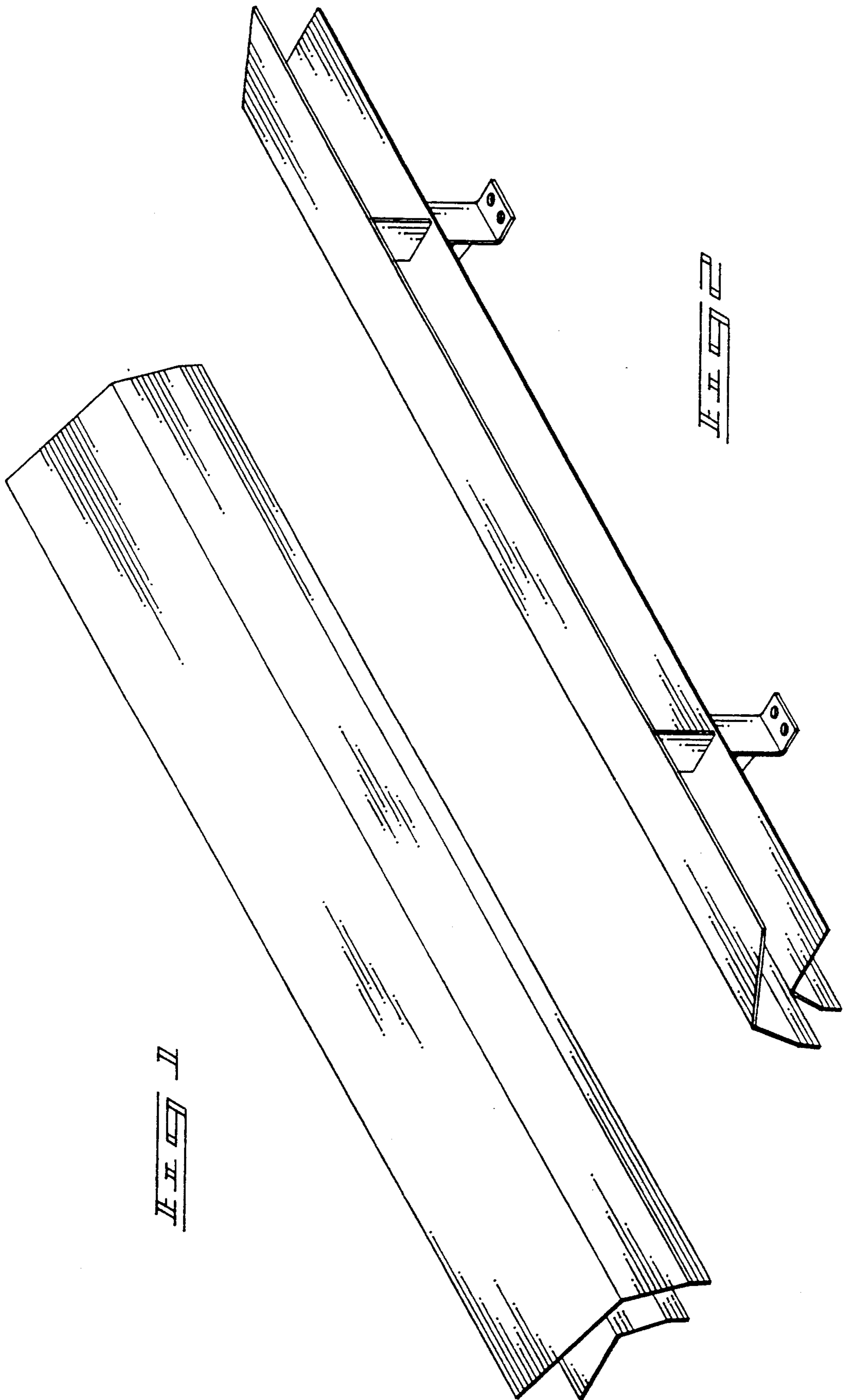

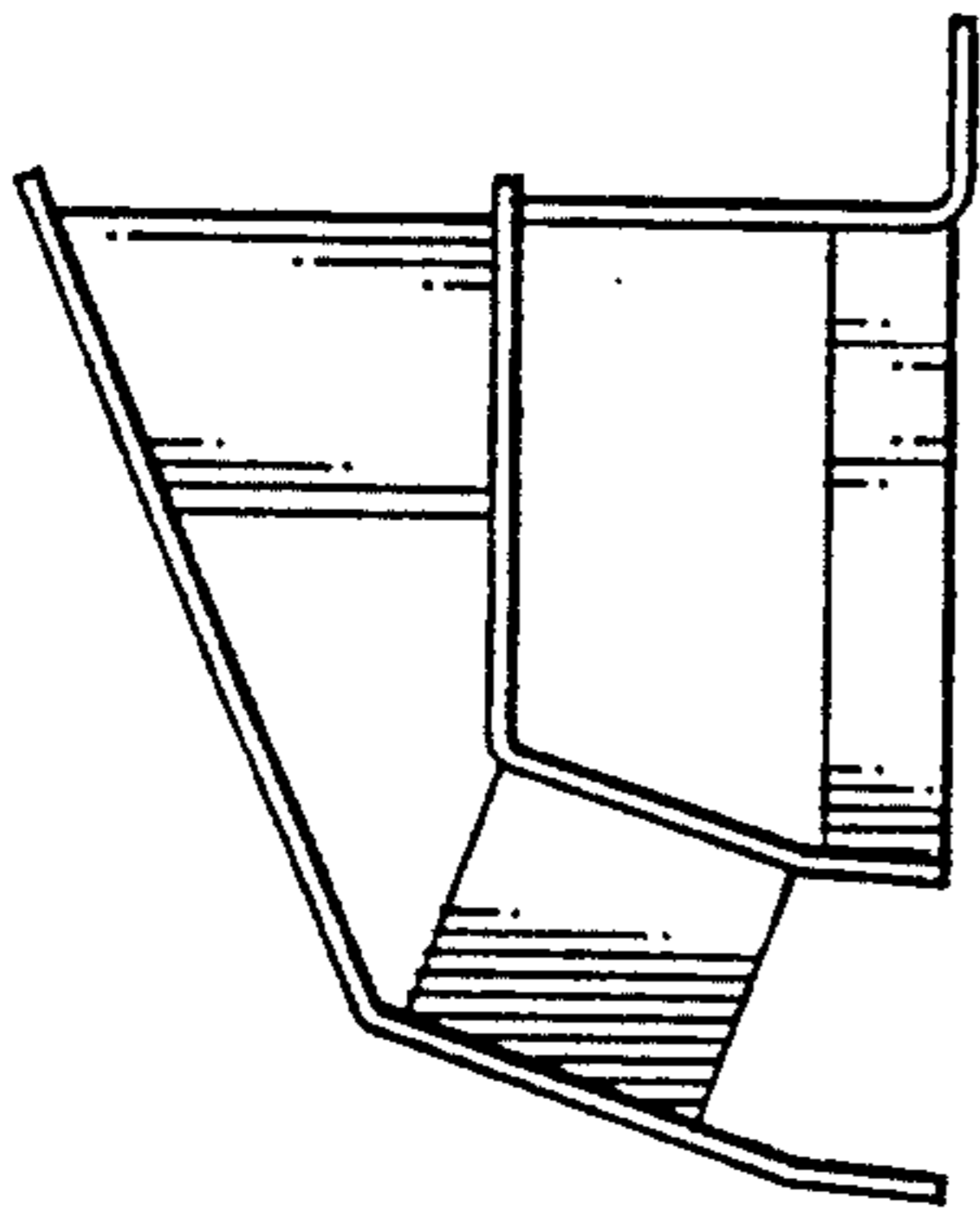

FIG. 1

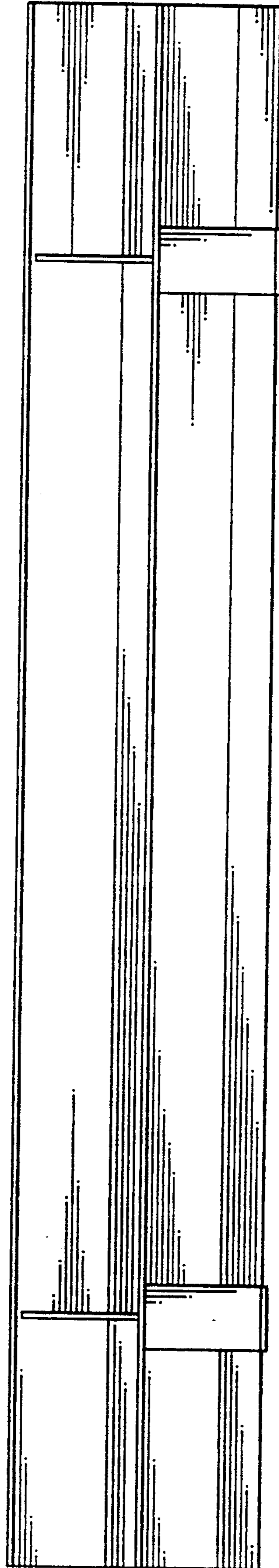

FIG. 2

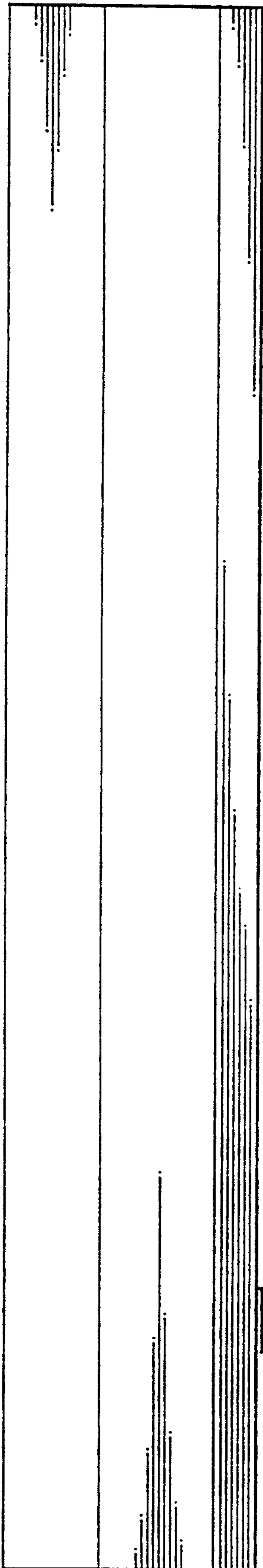

FIG. 5

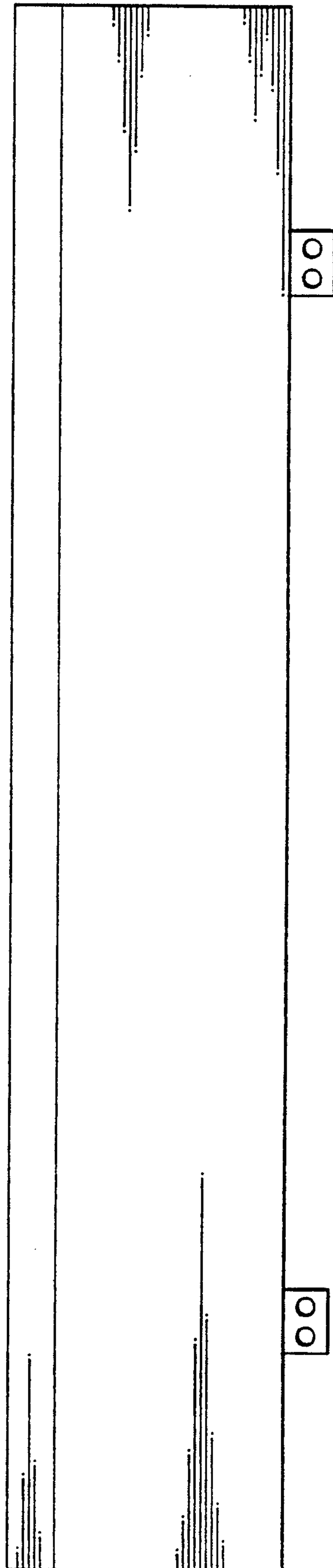

FIG. 6

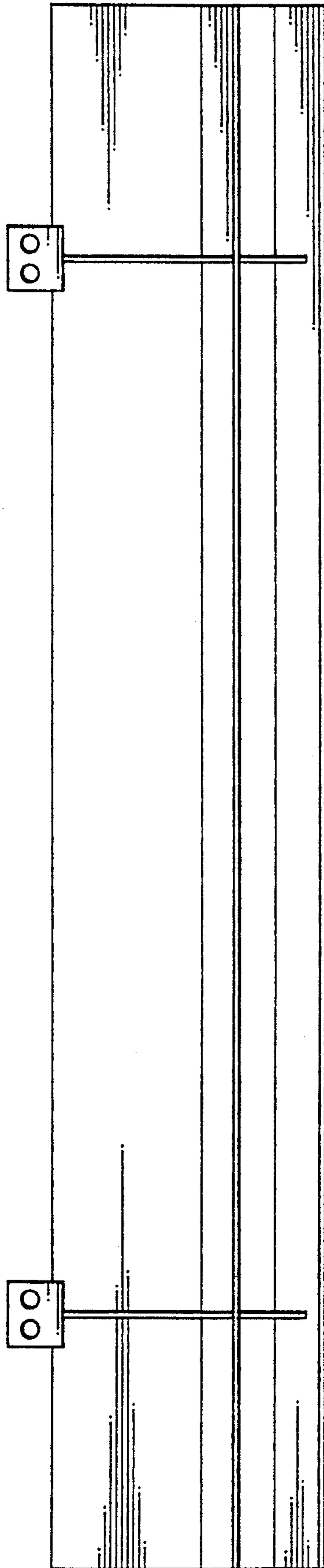

FIG. 4