



US00D336880S

**United States Patent** [19]  
**Drummond**

[11] **Patent Number: Des. 336,880**

[45] **Date of Patent: \*\* Jun. 29, 1993**

[54] **TRAILER HITCH COVER**

[76] **Inventor: William C. Drummond, 1716 Westlake, Plano, Tex. 75075**

[\*\*] **Term: 14 Years**

[21] **Appl. No.: 784,058**

[22] **Filed: Oct. 28, 1991**

[52] **U.S. Cl. .... D12/162**

[58] **Field of Search ..... D12/162; 280/507, 477**

[56] **References Cited**

**U.S. PATENT DOCUMENTS**

D. 317,890	7/1991	Bachmann	.....	D12/162
2,014,022	9/1935	Klein	.....	D21/104
3,990,722	11/1976	Casad et al.	.....	D12/162
4,509,770	4/1985	Young et al.	.....	280/507
4,738,293	4/1988	Ostrom et al.	.....	280/511
4,955,968	9/1990	Beckerer	.....	280/507
5,044,652	9/1991	Brisson	.....	D12/162

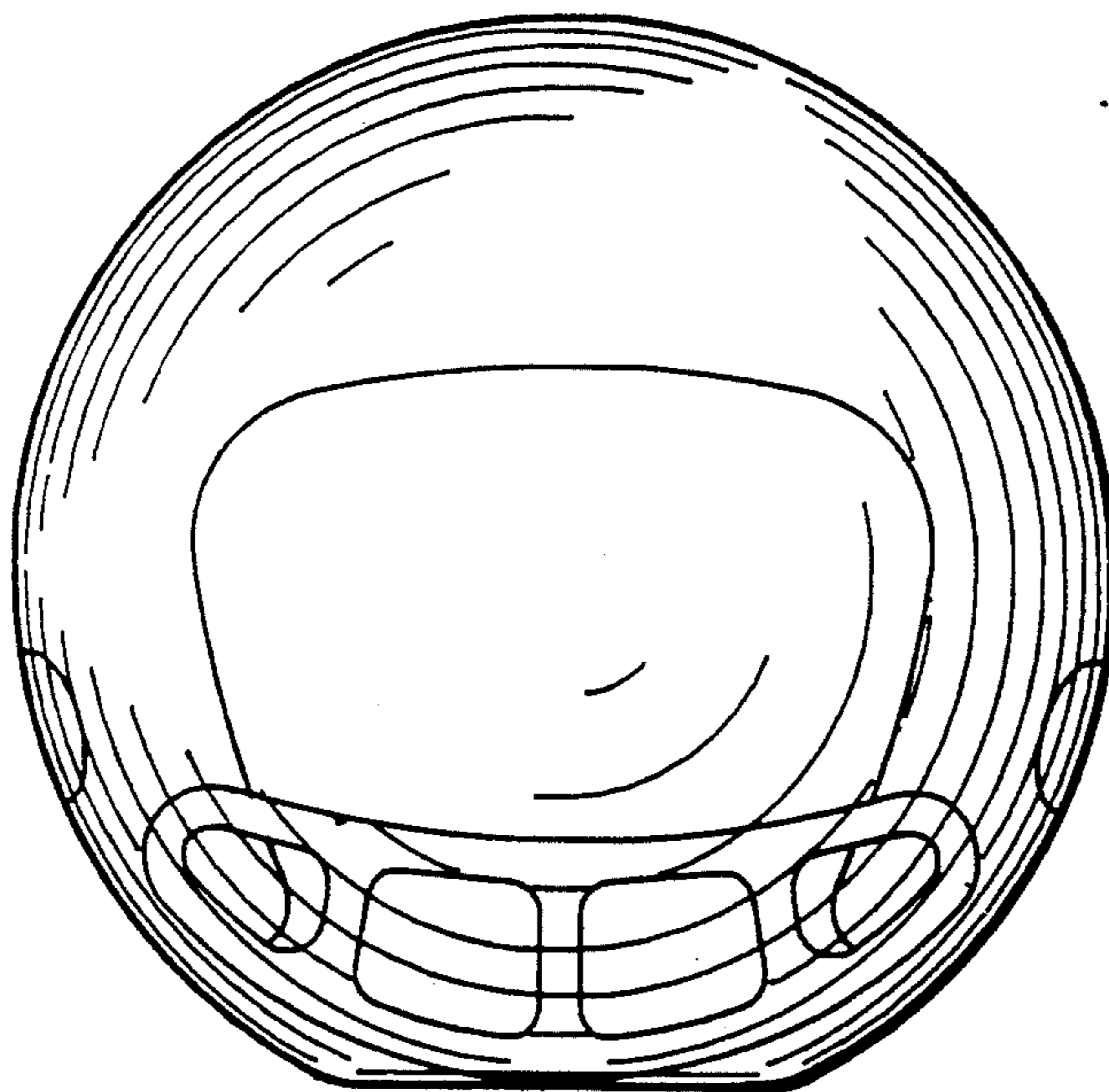
*Primary Examiner*—Wallace R. Burke  
*Assistant Examiner*—Melody Brown  
*Attorney, Agent, or Firm*—Timmons & Kelly

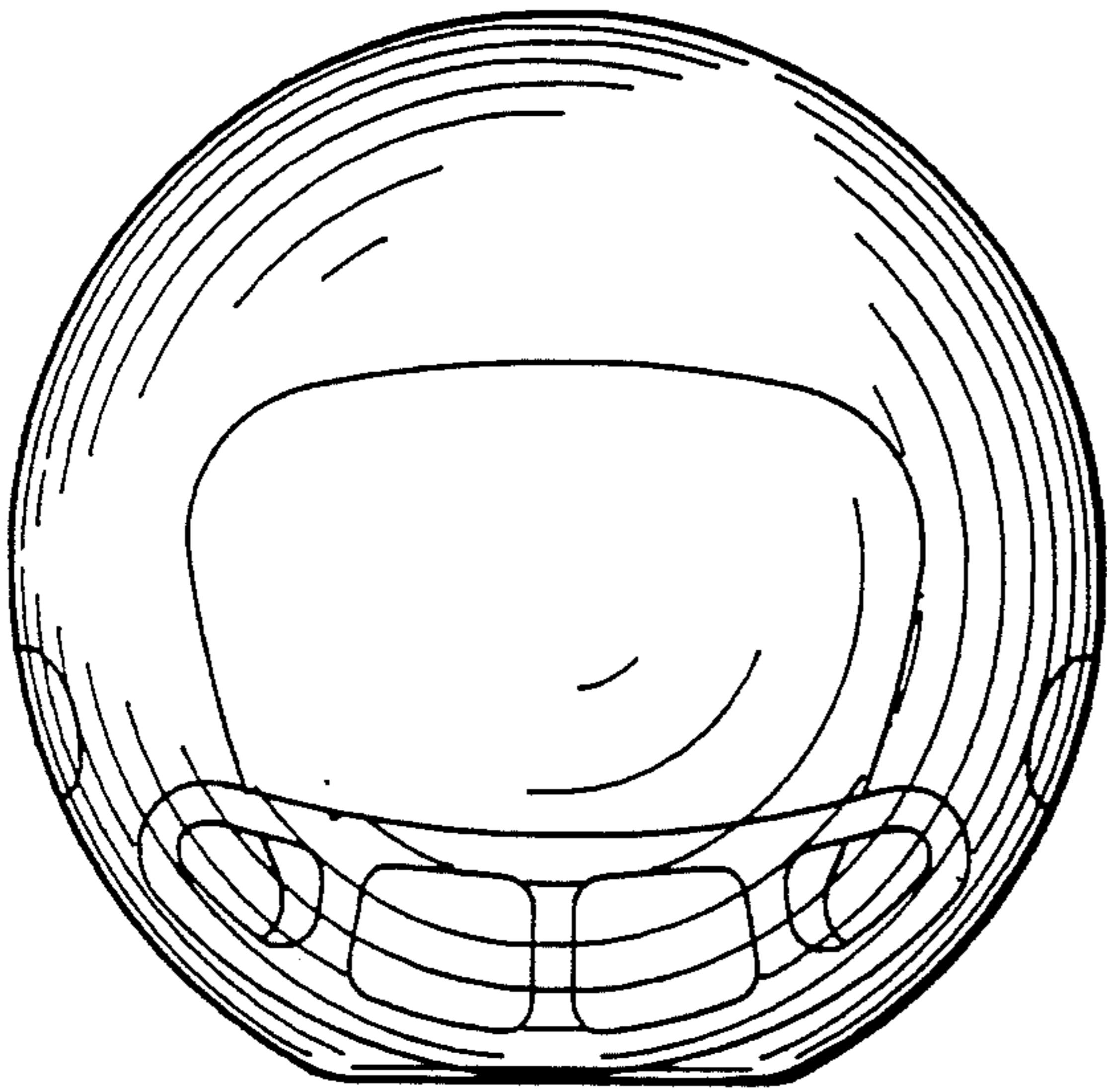
[57] **CLAIM**

The ornamental design for a trailer hitch cover, as shown and described.

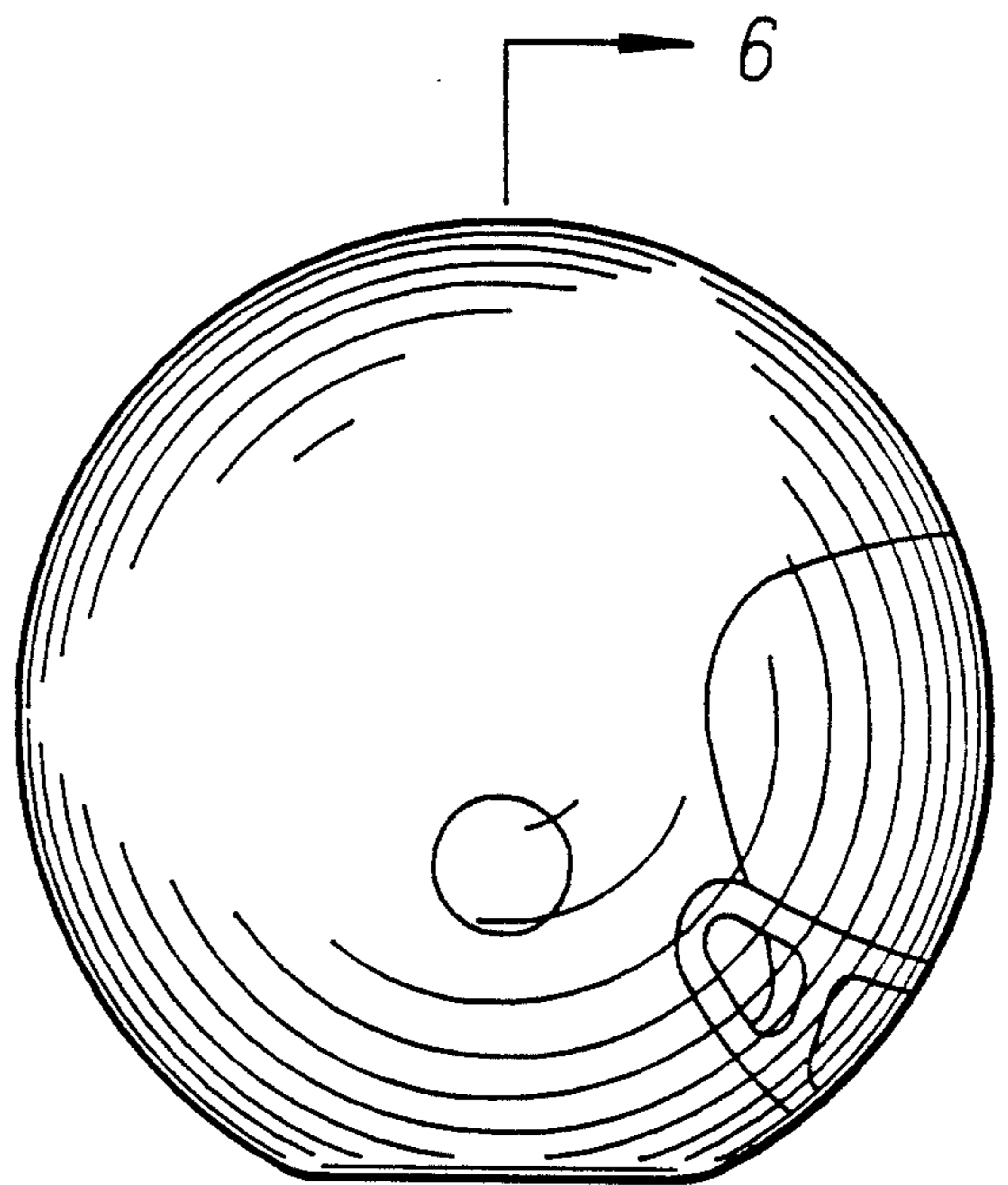
**DESCRIPTION**

FIG. 1 is a front elevation view of the trailer hitch cover;  
FIG. 2 is a rear elevation view of the trailer hitch cover;  
FIG. 3 is a side elevation view of the trailer hitch cover;  
FIG. 4 is a top plan view of the trailer hitch cover;  
FIG. 5 is a bottom plan view of the trailer hitch cover;  
and,  
FIG. 6 is a sectional view of the trailer hitch cover shown as it covers a ball hitch, as seen along lines 6—6 in FIG. 3.  
The broken lines are for illustrative purposes only and form no part of the claimed design.

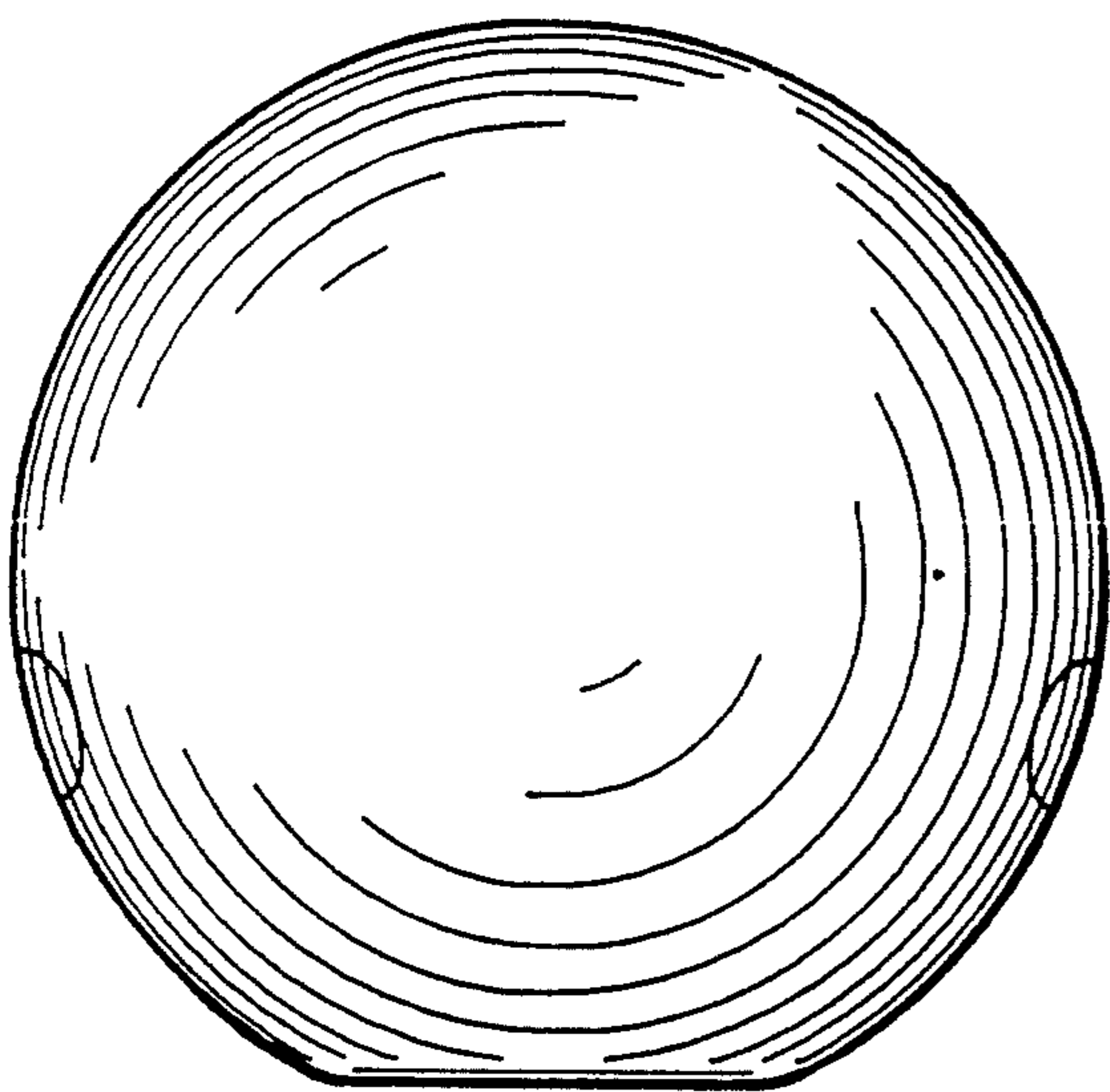




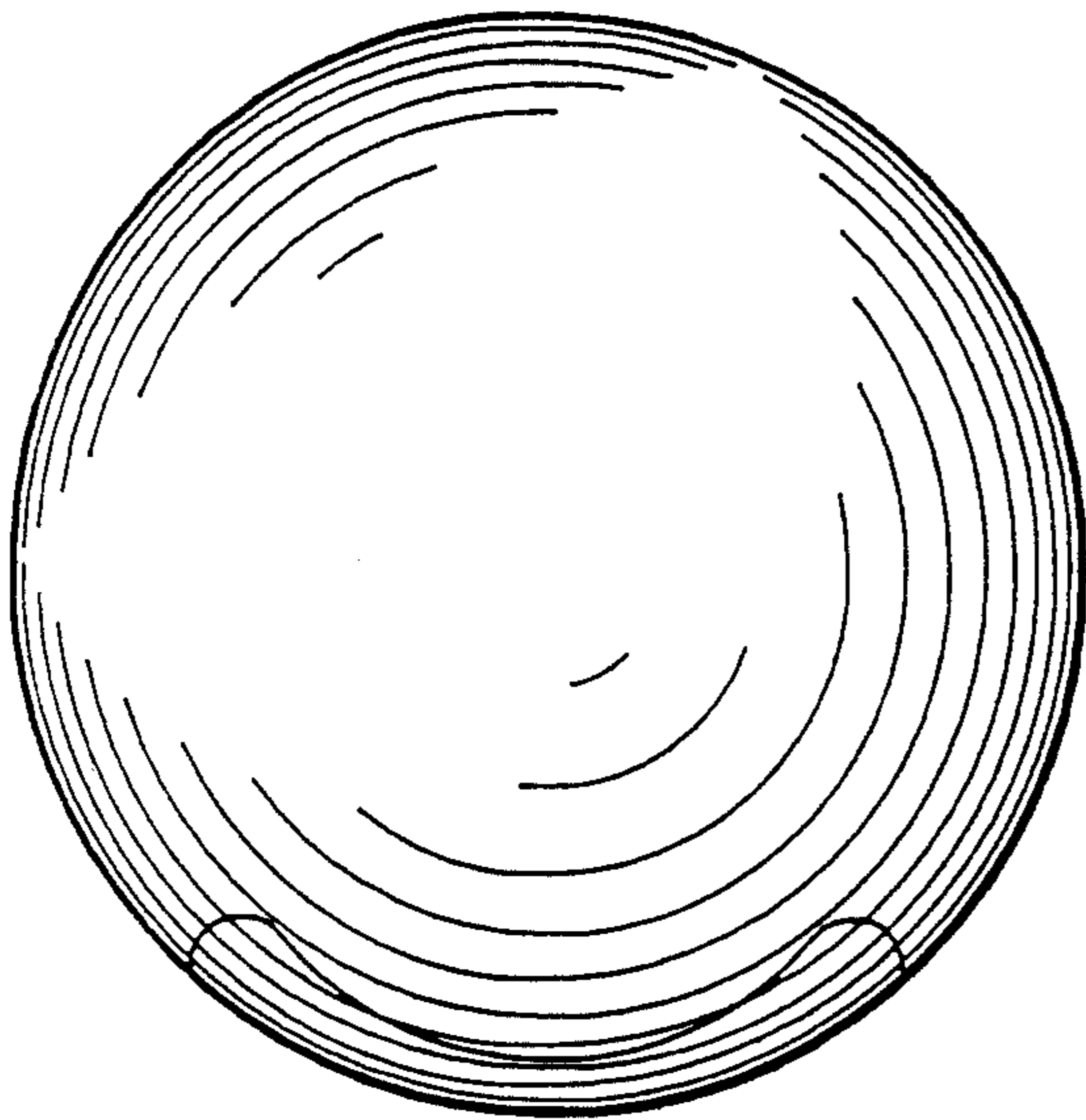
*Fig. 1*



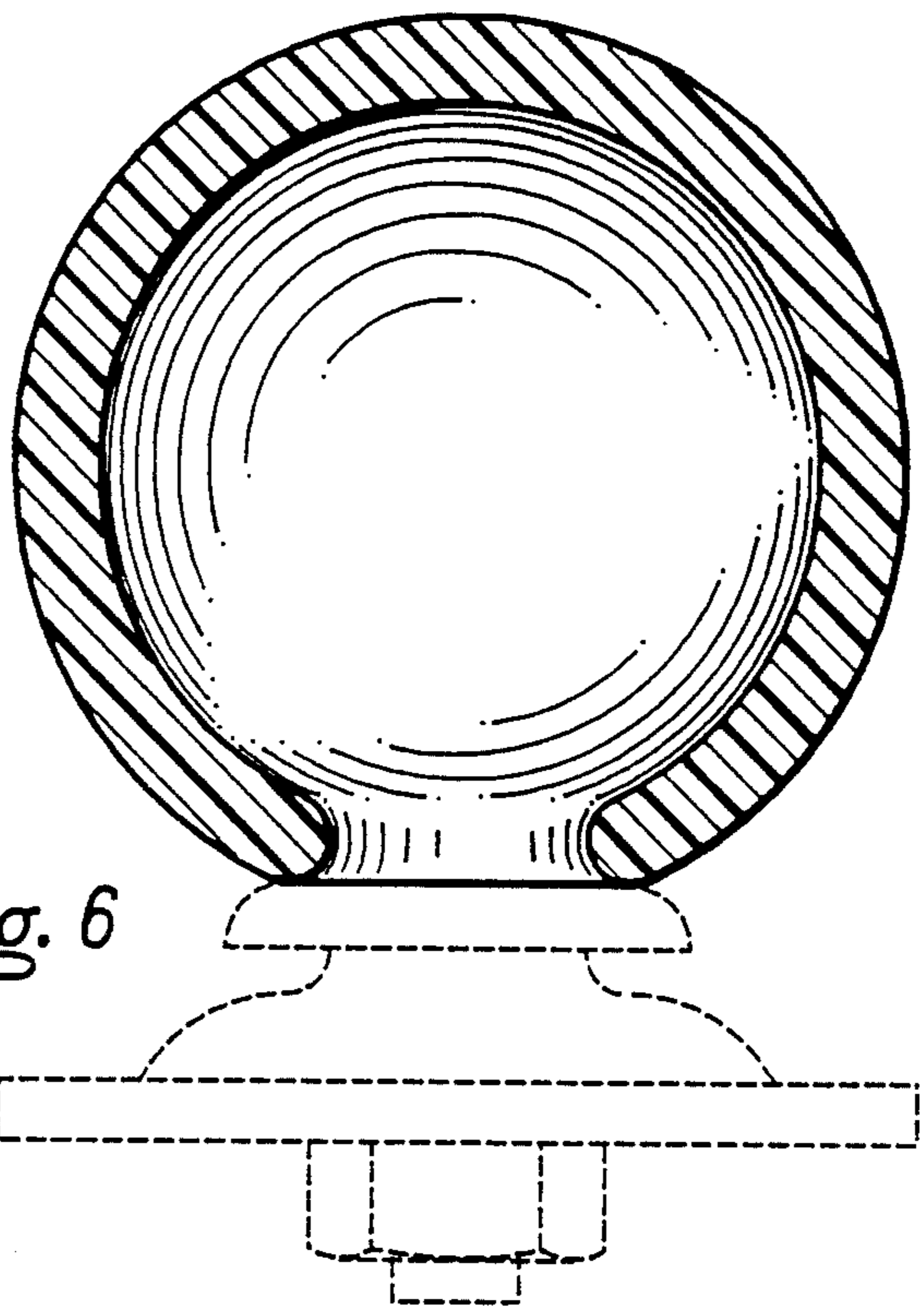
*Fig. 3*



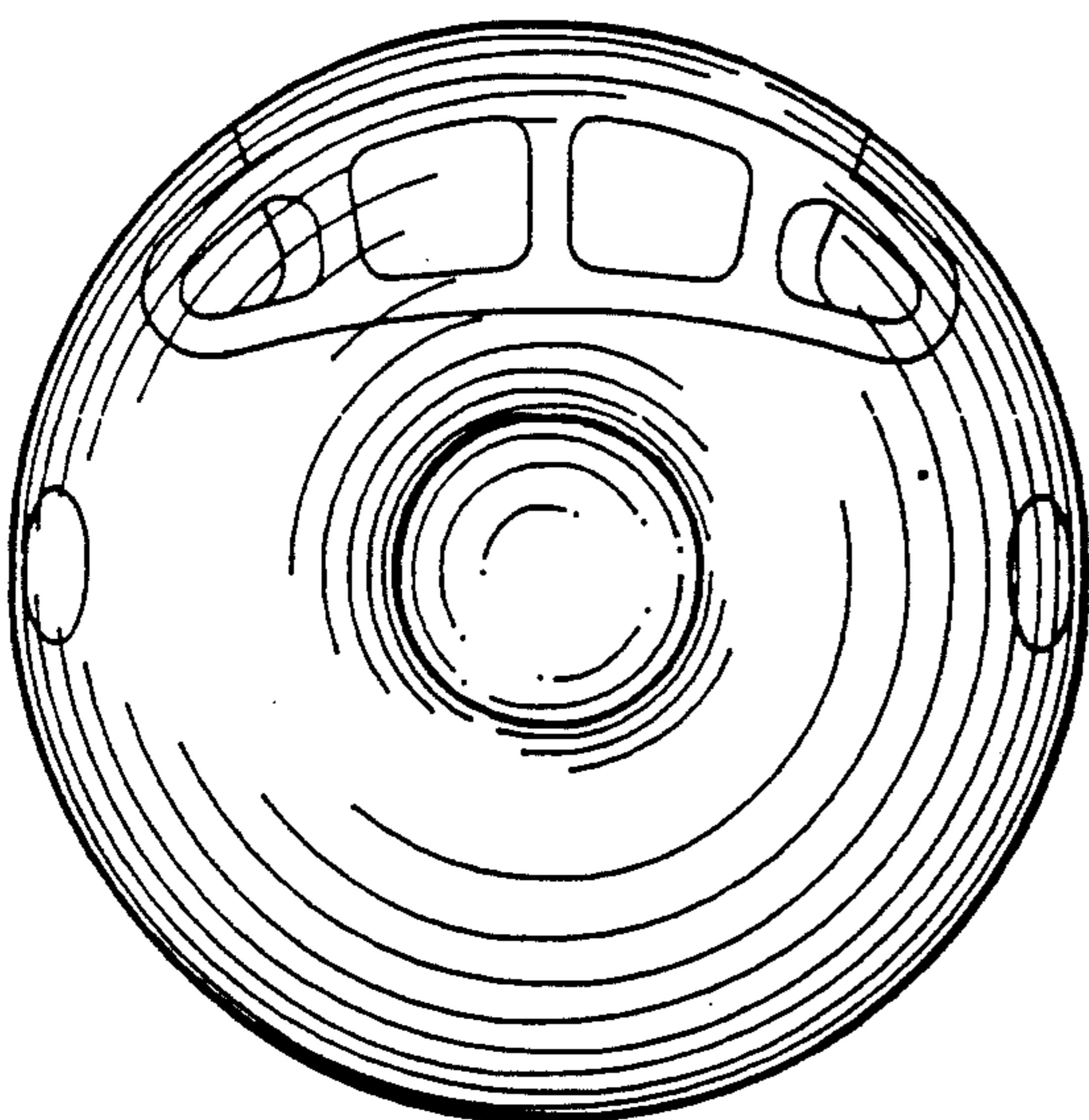
*Fig. 2*



*Fig. 4*



*Fig. 6*



*Fig. 5*