



US00D336785S

United States Patent [19]

[11] Patent Number: **Des. 336,785**

Matsuda

[45] Date of Patent: **** Jun. 29, 1993**

[54] **BABY CHAIR**

[75] Inventor: **Hiroaki Matsuda, Tokyo, Japan**

[73] Assignee: **Combi Corporation, Tokyo, Japan**

[**] Term: **14 Years**

[21] Appl. No.: **681,201**

[22] Filed: **Apr. 5, 1991**

[30] **Foreign Application Priority Data**

Oct. 31, 1990 [JP] Japan 2-36580

[52] U.S. Cl. **D6/333; D6/335; D6/344**

[58] Field of Search **D6/333, 335, 339, 368, D6/373, 374; 297/DIG. 2, 152, 192, 183, 250, 416; 248/345.1**

[56] **References Cited**

U.S. PATENT DOCUMENTS

D. 246,682 12/1977 Nakao D6/333 X

D. 254,699 4/1980 Nakao et al. D6/333 X
D. 291,156 8/1987 Nakao et al. D6/339 X
D. 303,459 9/1989 Nakao et al. D6/333
3,884,495 5/1975 Petock 248/345.1 X

Primary Examiner—Alan P. Douglas
Assistant Examiner—Monica A. Hannon
Attorney, Agent, or Firm—Sughrue Mion Zinn Macpeak & Seas

[57] **CLAIM**

The ornamental design for a baby chair, as shown.

DESCRIPTION

FIG. 1 is a front, top and left side perspective view of a baby chair showing my new design;
FIG. 2 is a front elevational view thereof;
FIG. 3 is a rear elevational view thereof;
FIG. 4 is a left side elevational view thereof;
FIG. 5 is a right side elevational view thereof;
FIG. 6 is a top plan view thereof; and,
FIG. 7 is a bottom plan view thereof.

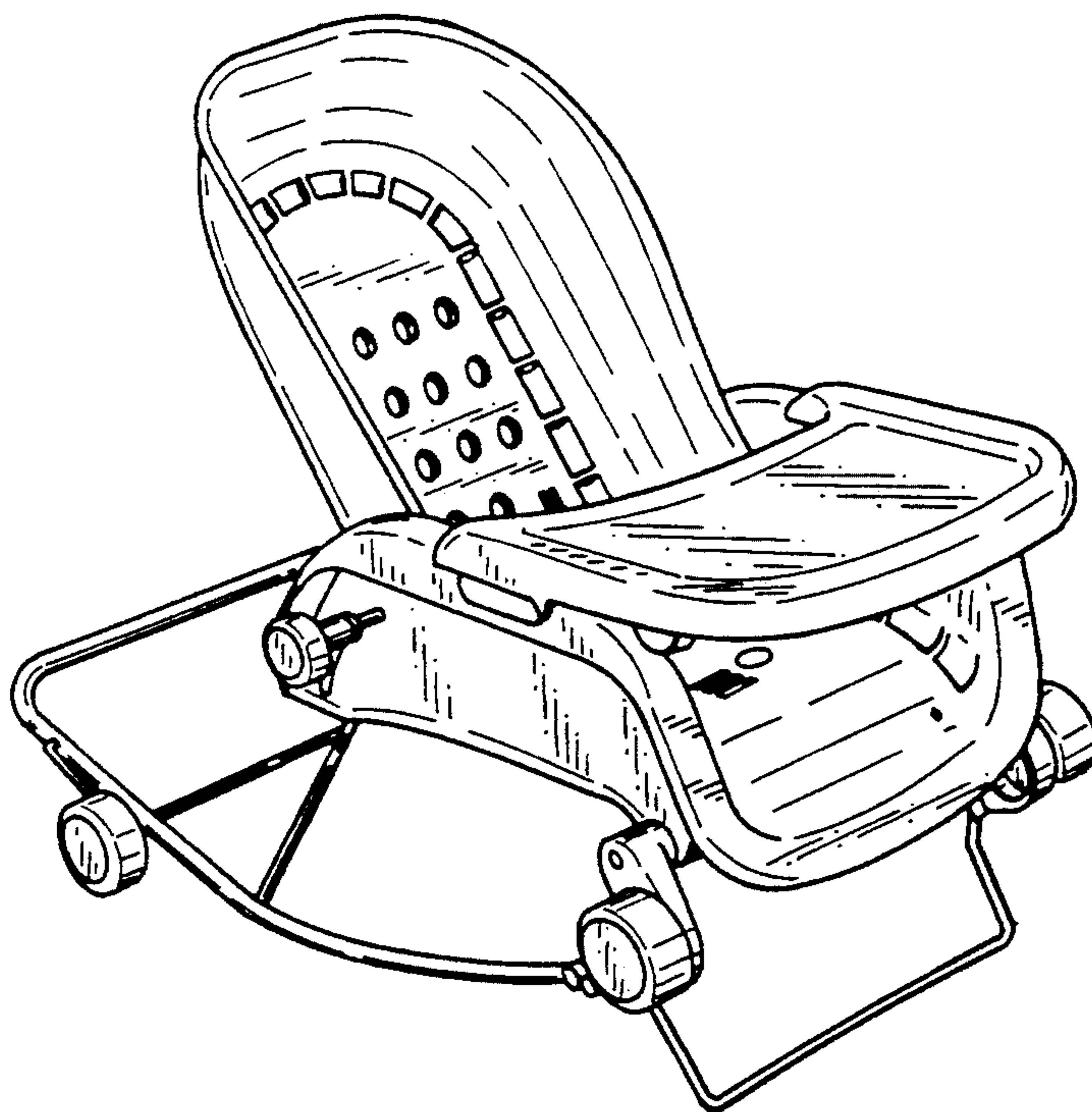

Fig. 1

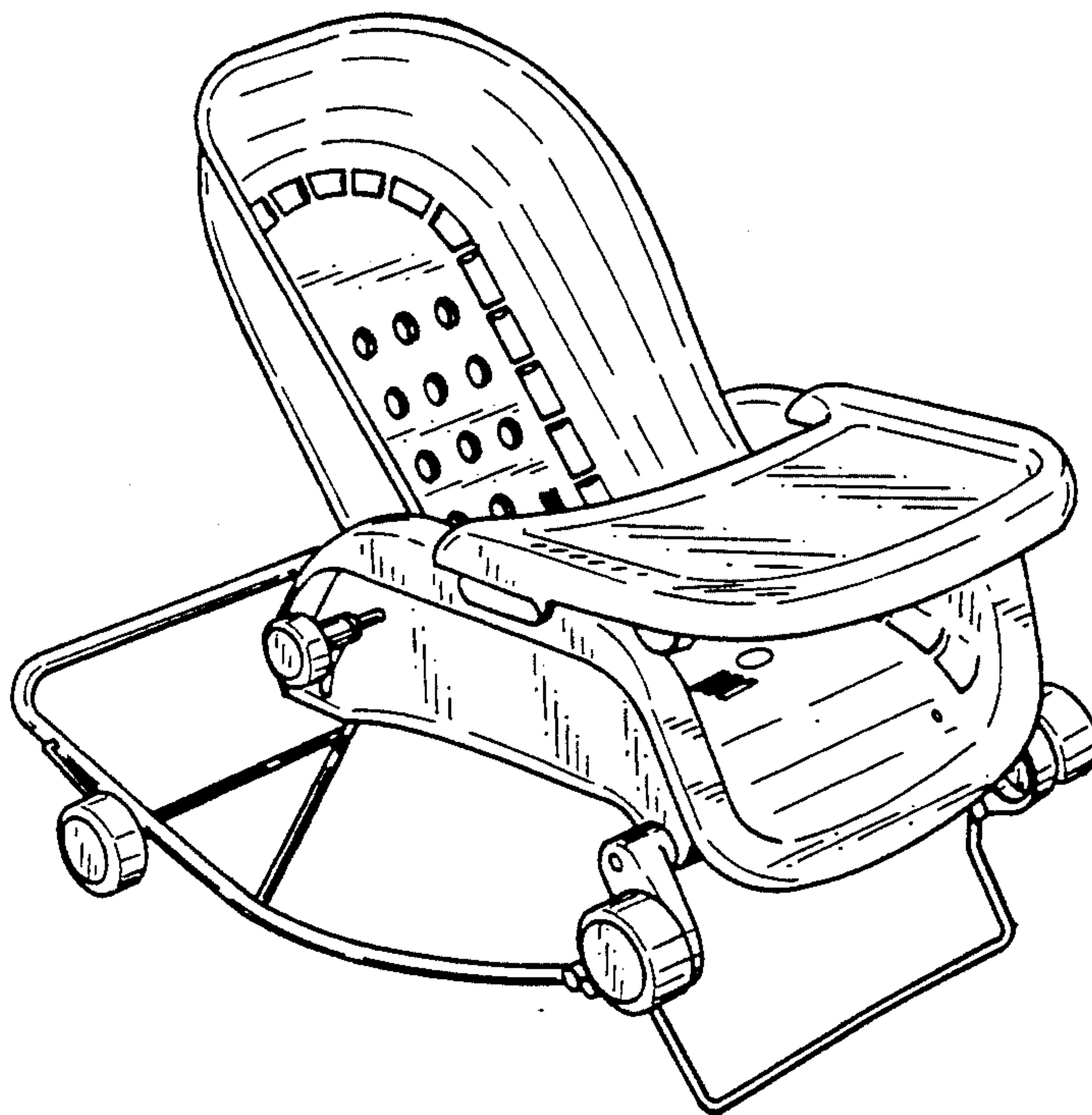

Fig. 2

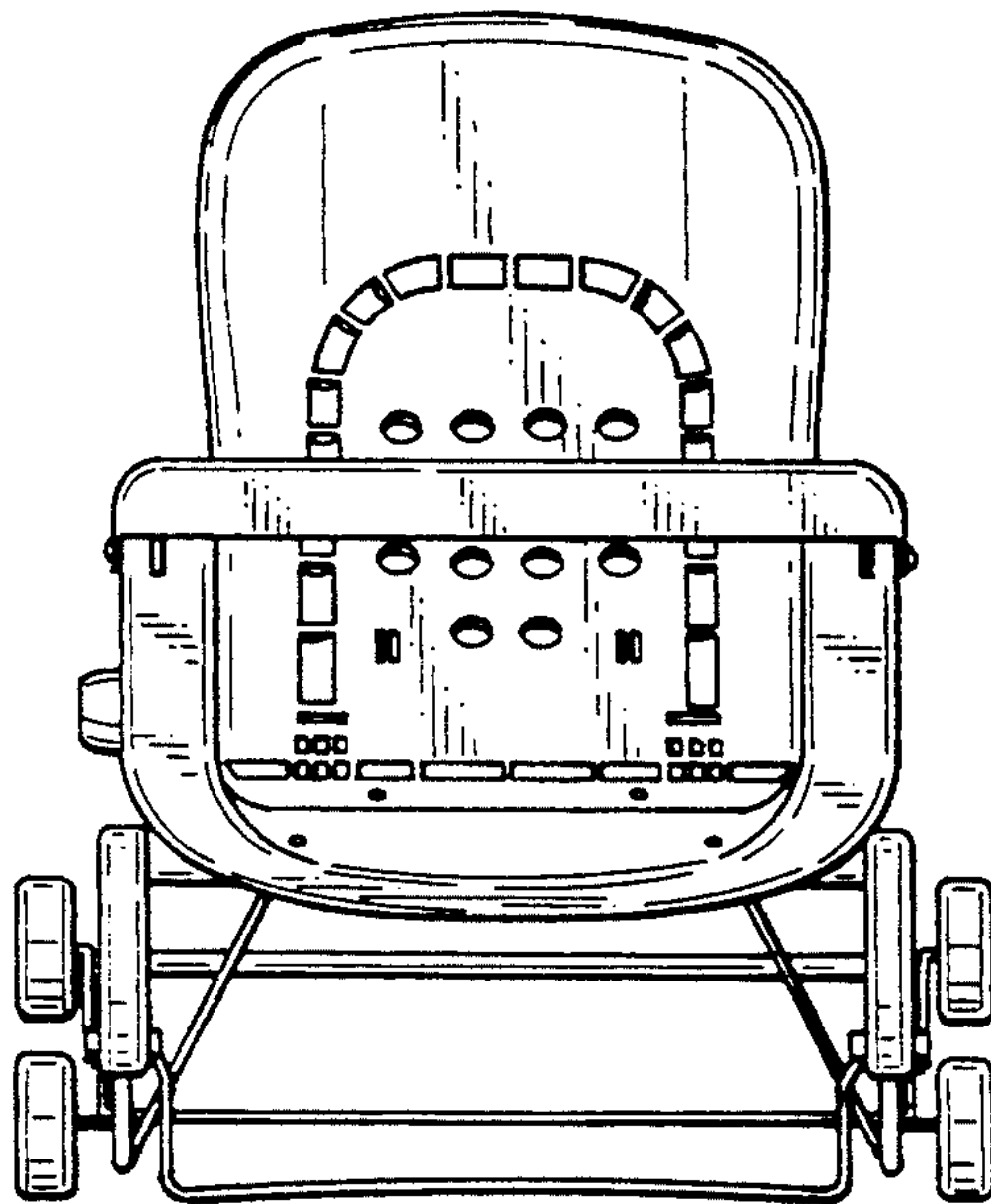

Fig. 3

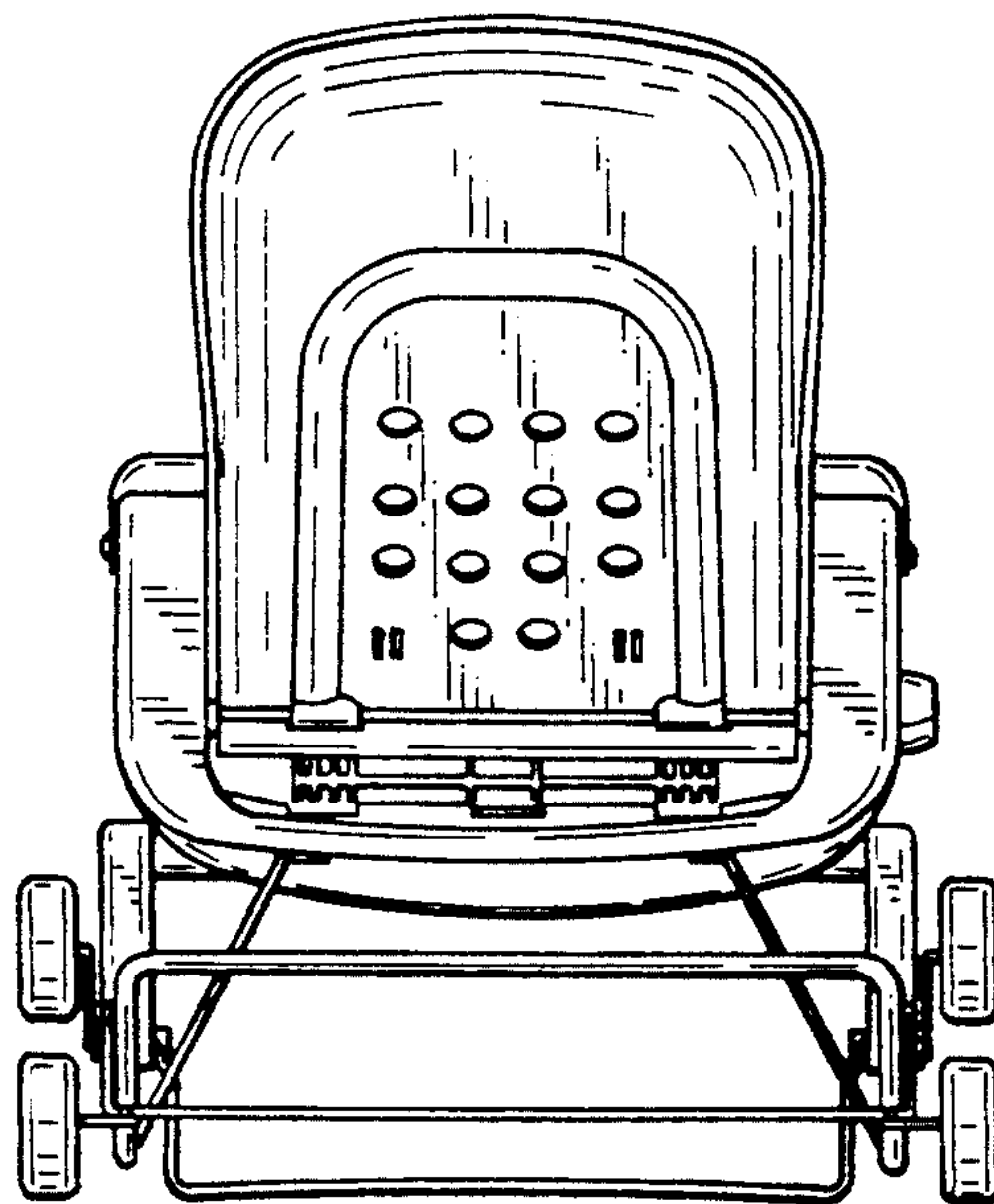

Fig. 4

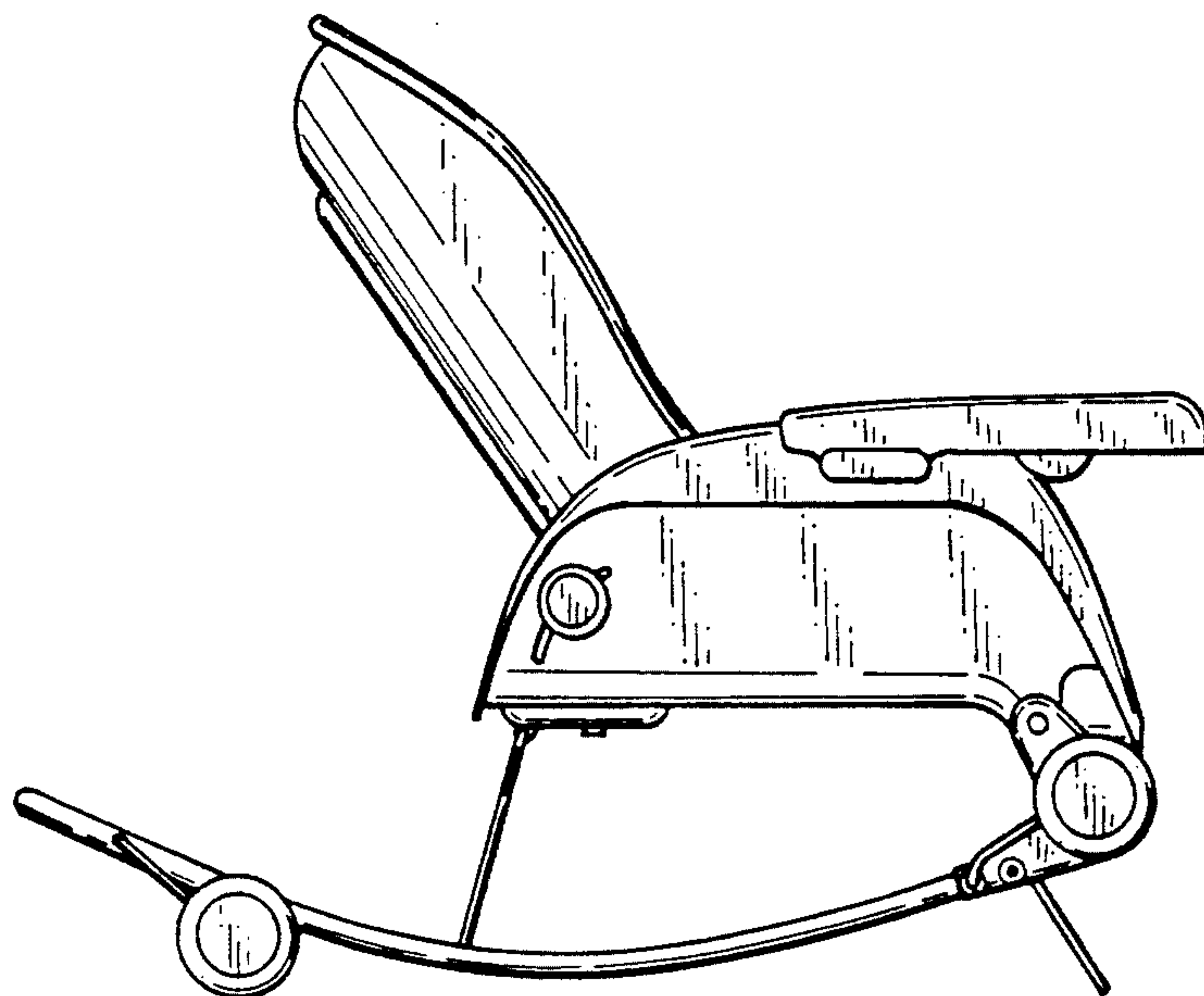

Fig. 5

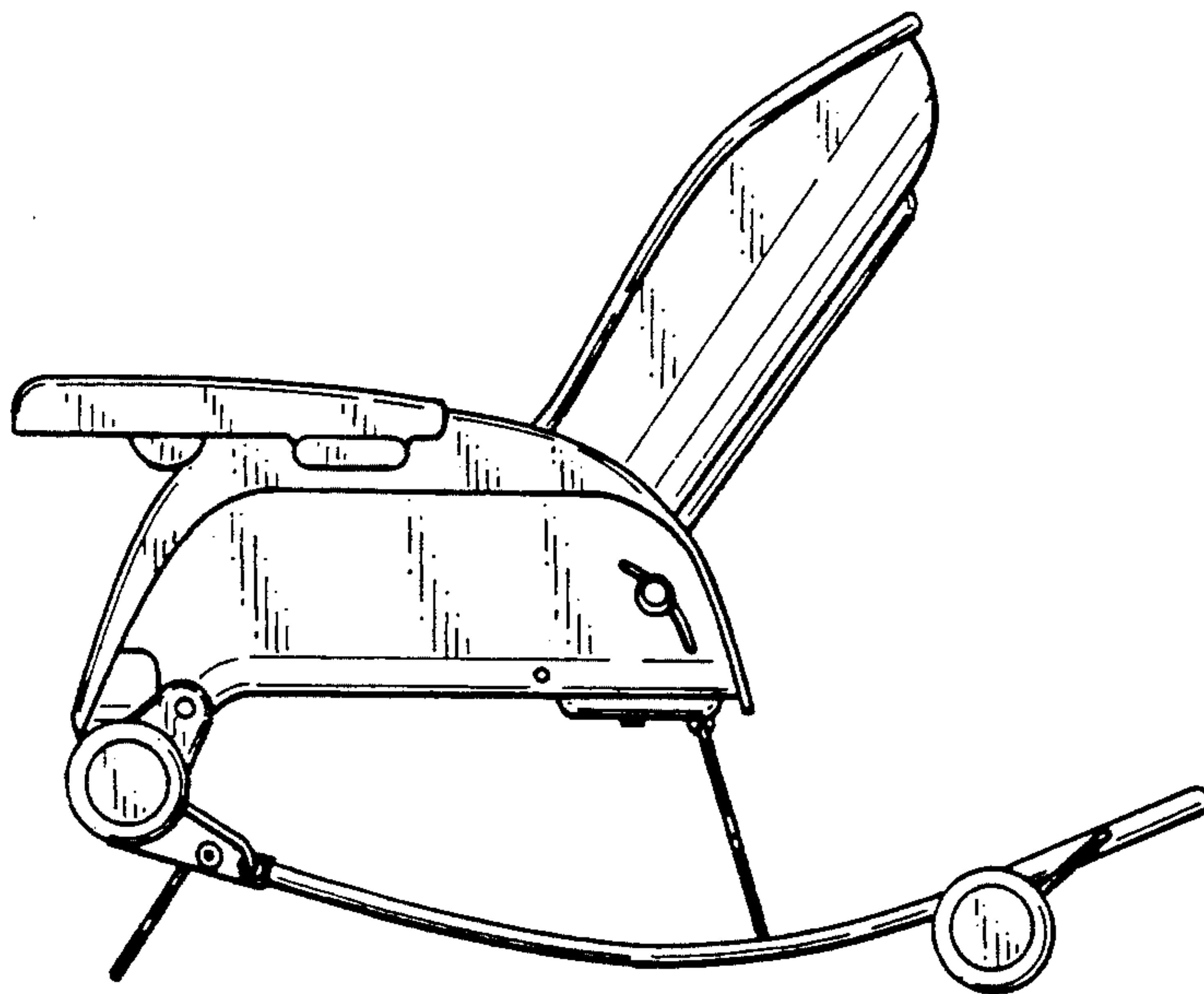

Fig. 7

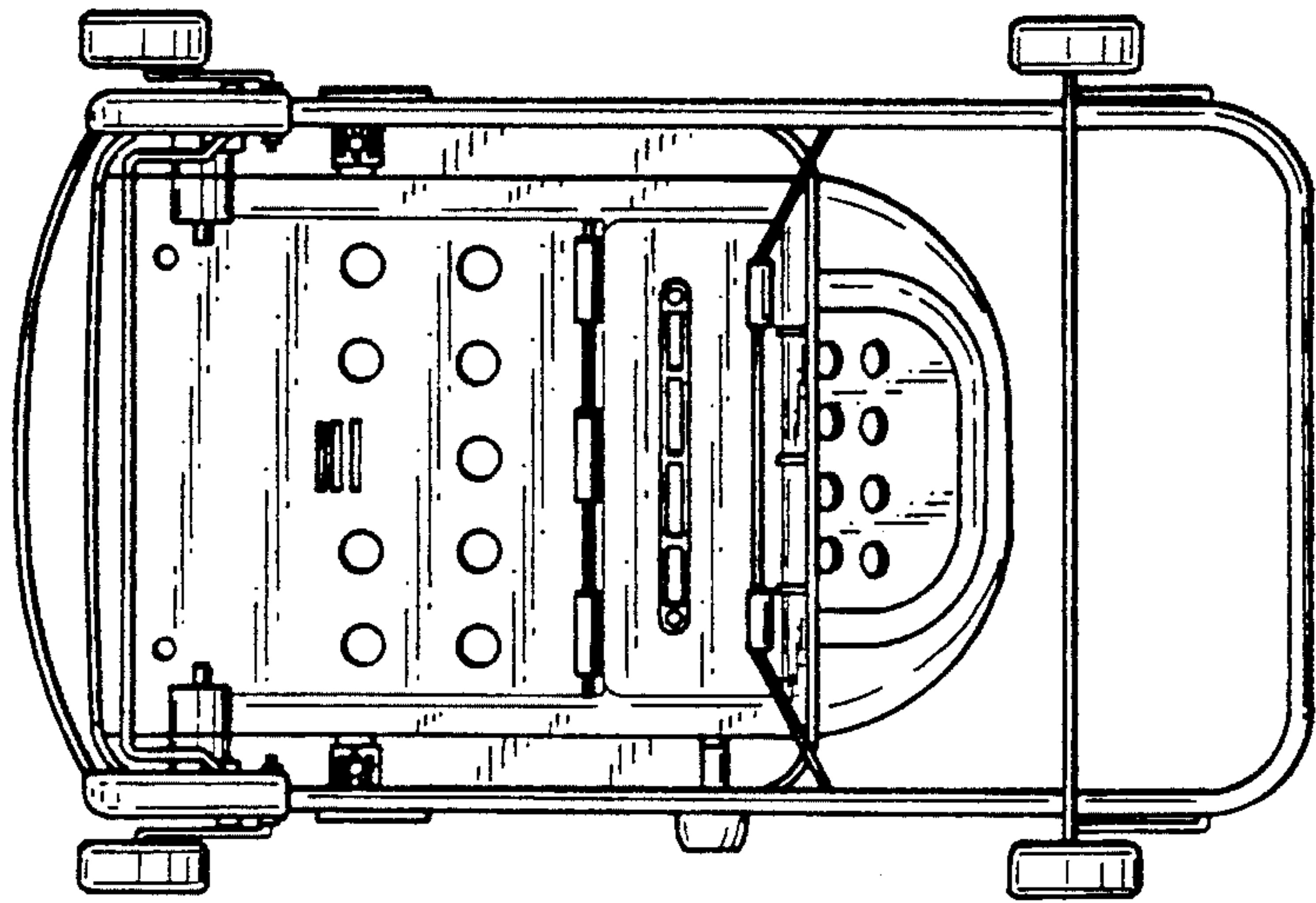

Fig. 6

