



US00D336782S

United States Patent [19]

[11] Patent Number: Des. 336,782

Vela et al.

[45] Date of Patent: ** Jun. 29, 1993

[54] COMBINED TOOTHBRUSH, TOOTHPASTE DISPENSER AND DENTAL FLOSS HOLDER UNIT AND COVER THEREFOR

1,653,987	12/1927	Cliffe	401/129
3,227,165	1/1966	Costanza	401/271 X
3,853,134	12/1974	McCord	401/286 X
4,283,808	8/1981	Beebe	15/167.1 X
4,821,752	4/1989	Widlak	132/309

[76] Inventors: Raul Vela, P.O. Box 1135, 412 W. 2nd St.; Jacinto Tamez, Jr., P.O. Box 797, 334 W. 8th St., both of Elsa, Tex. 78543

Primary Examiner—Wallace R. Burke
Assistant Examiner—Lavone D. Tabor
Attorney, Agent, or Firm—Leon Gilden

[**] Term: 14 Years

[57] CLAIM

[21] Appl. No.: 584,862

The ornamental design for a combined toothbrush, toothpaste dispenser and dental floss holder unit and cover therefor, as shown and described.

[22] Filed: Sep. 19, 1990

[52] U.S. Cl. D4/108; D4/114; D28/64

DESCRIPTION

[58] Field of Search D4/100, 102, 104-114, D4/116, 121, 130, 134, 136, 138, 199; D28/64; 15/104.92, 143 R, 159 R, 159 A, 160, 167.1-167.2; 132/308-313, 324, 326-328; 401/126, 129, 268-271, 282, 286, 290

FIG. 1 is a front elevational view of a combined toothbrush, toothpaste dispenser and dental floss holder unit and cover therefor showing my new design; FIG. 2 is a rear elevational view thereof; FIG. 3 is a left side elevational view thereof; FIG. 4 is a right side elevational view thereof; FIG. 5 is an enlarged top plan view thereof; FIG. 6 is a bottom plan view thereof; FIG. 7 is an exploded bottom perspective view thereof; and, FIG. 8 is a top perspective view thereof.

[56] References Cited

U.S. PATENT DOCUMENTS

D. 134,367	11/1942	Fry et al.	D4/108
D. 296,270	6/1988	Endo	D4/108
D. 318,761	8/1991	Parhiskari	D4/108

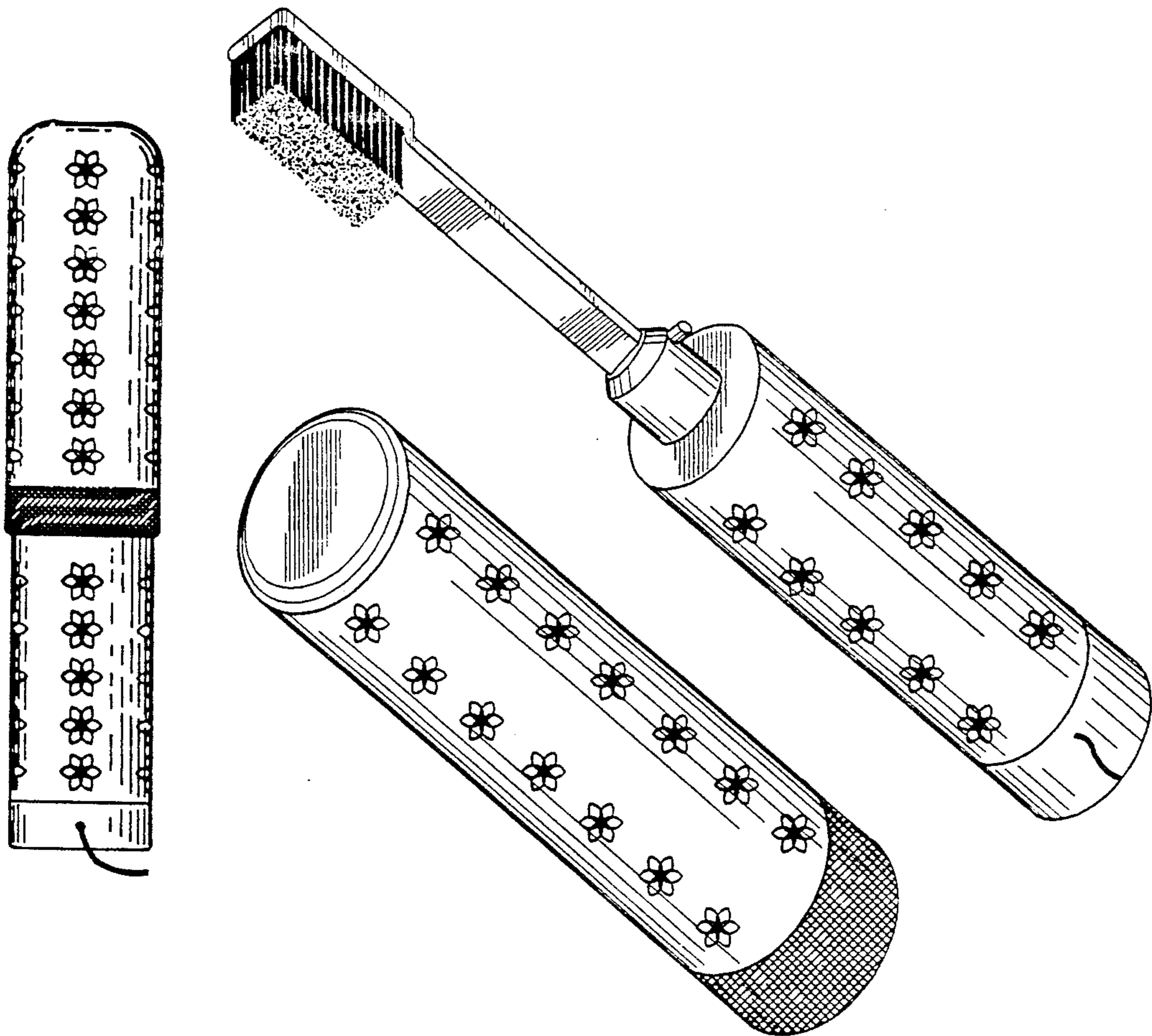

FIG. 1

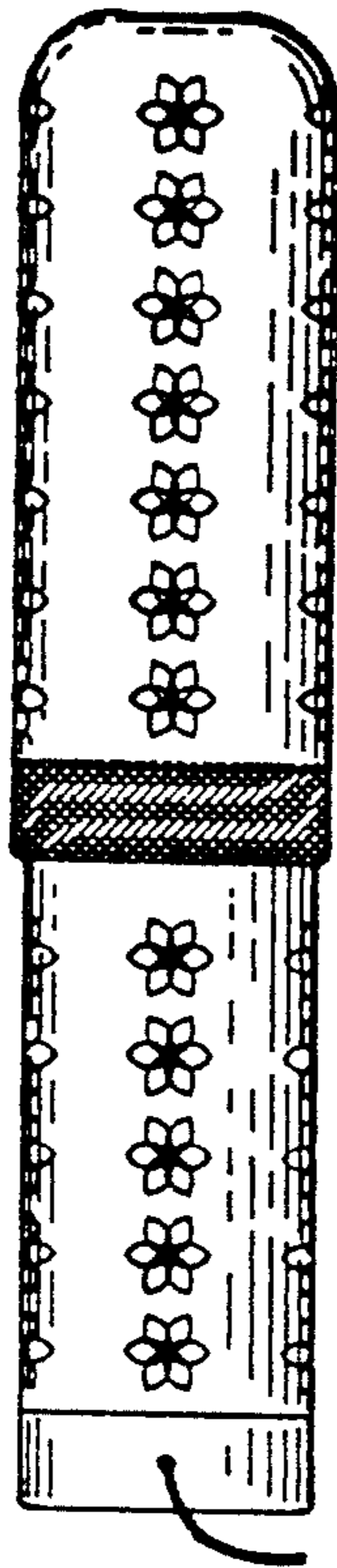

FIG. 2

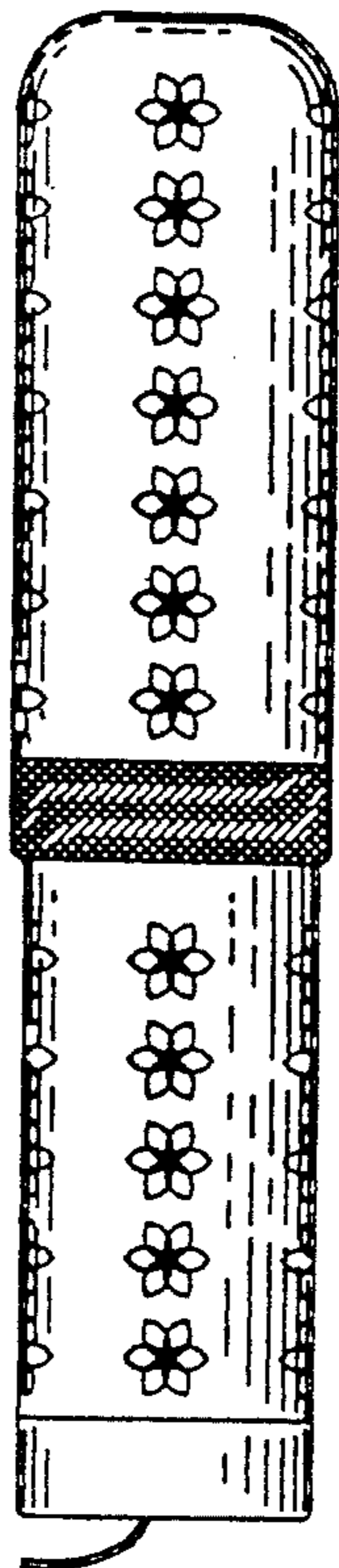

FIG. 3

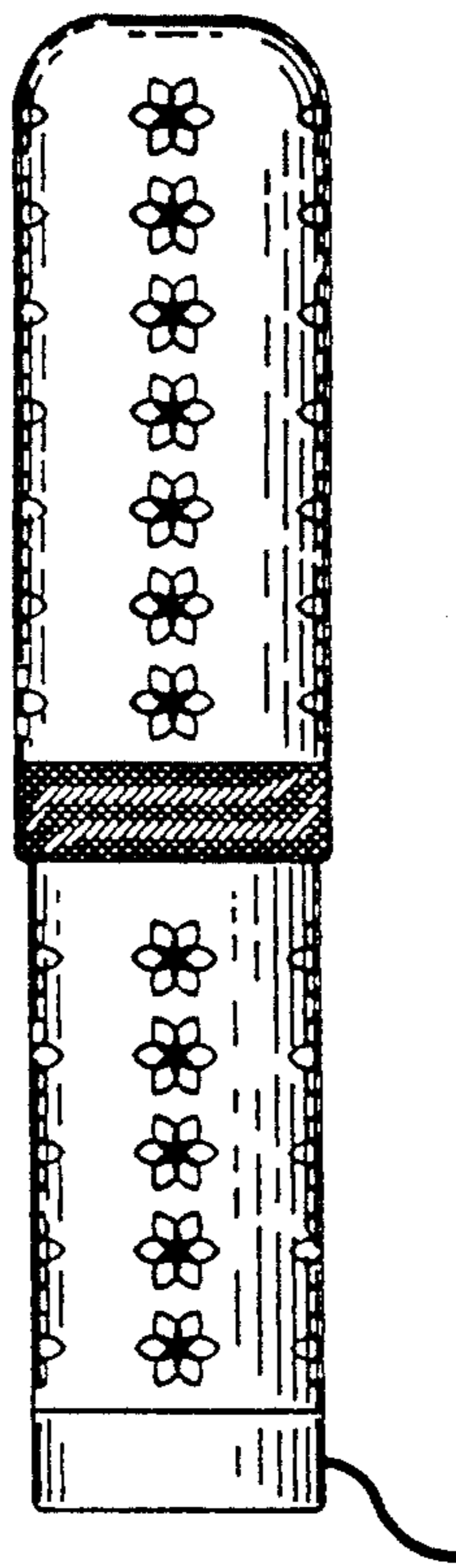

FIG. 4

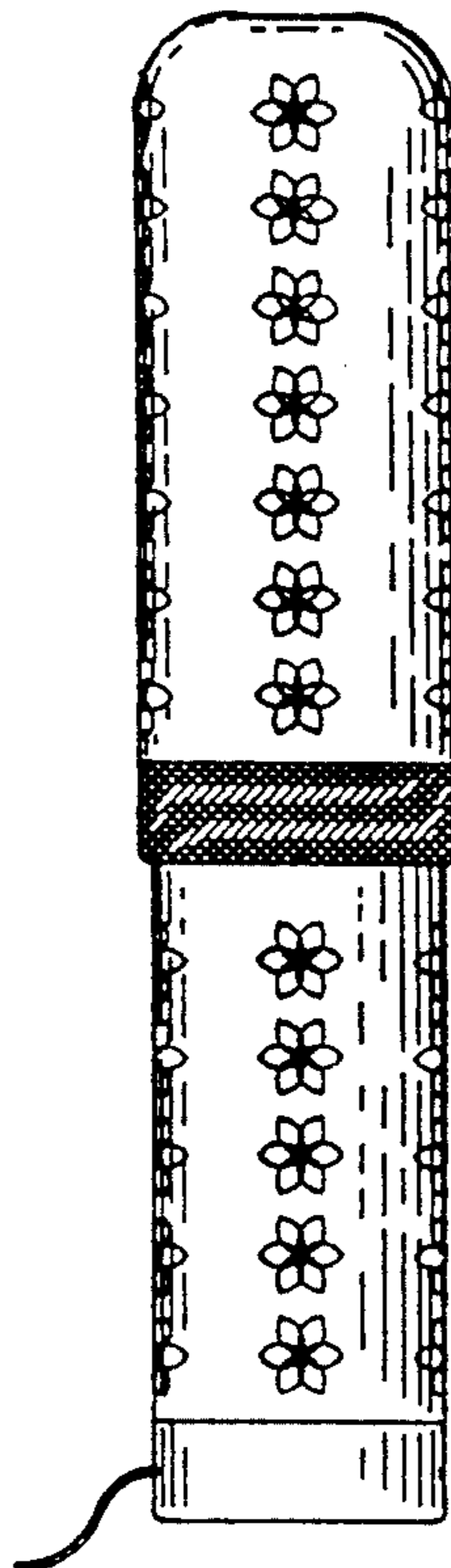

FIG. 5

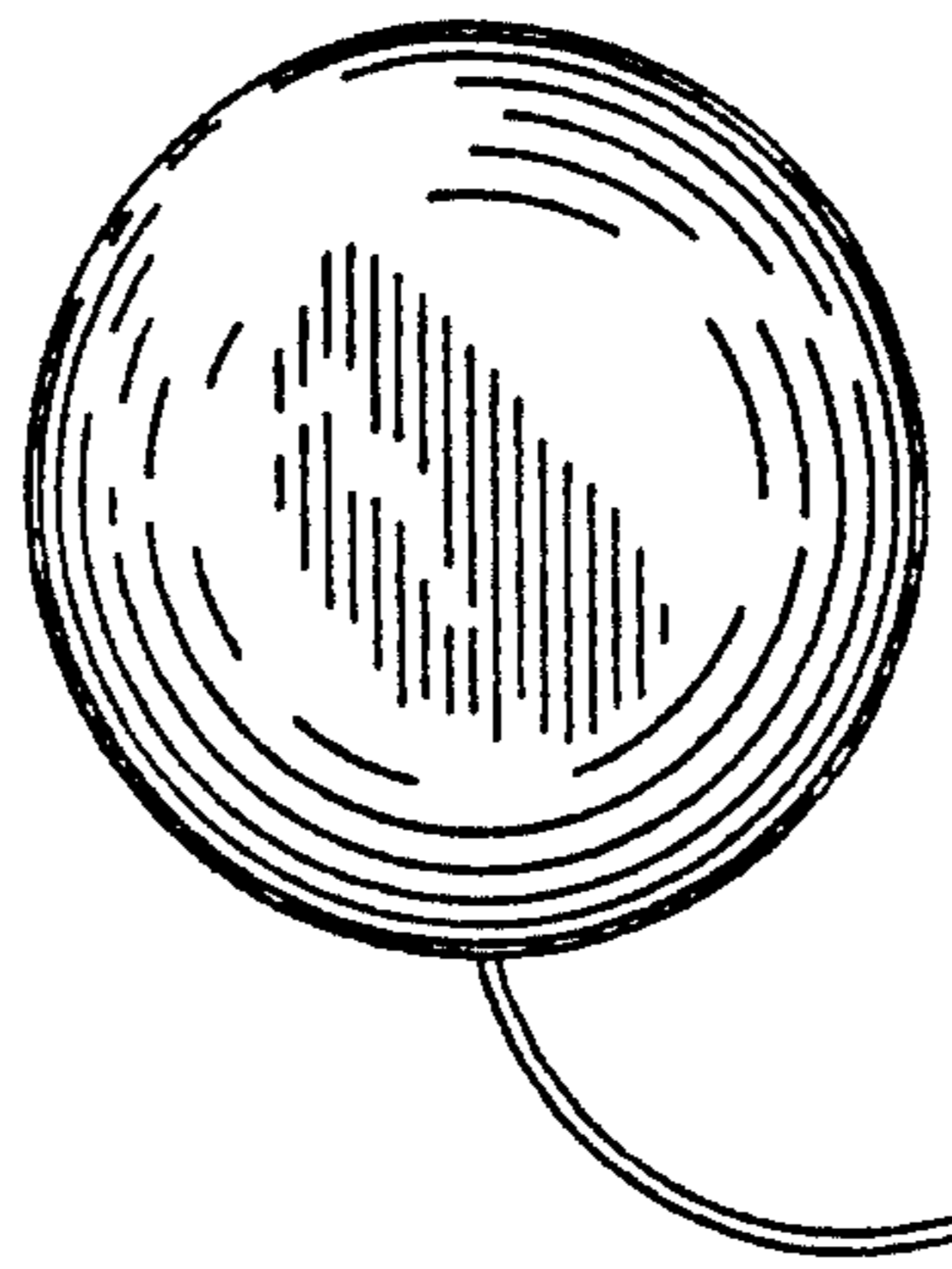

FIG. 6

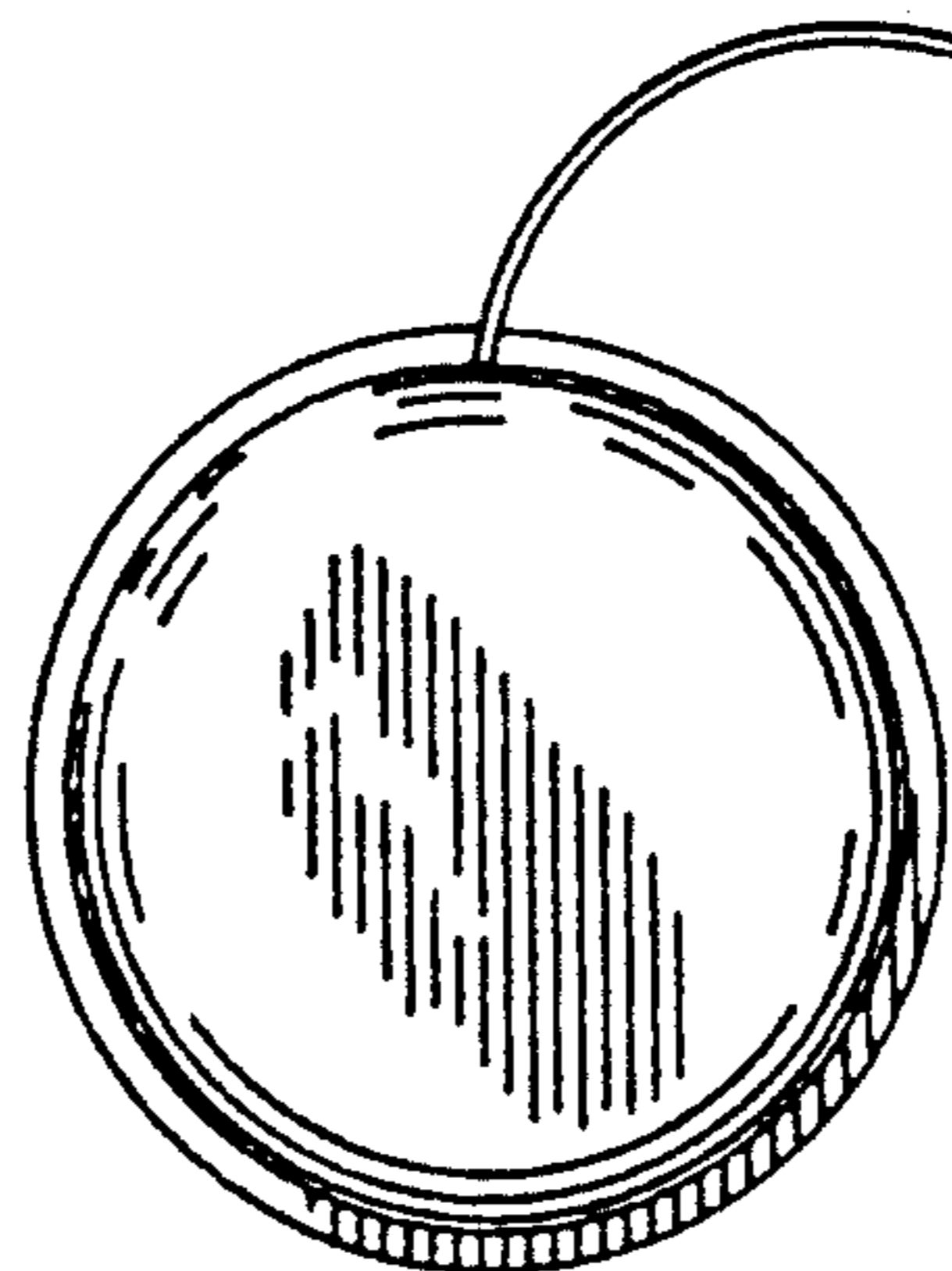

FIG. 7

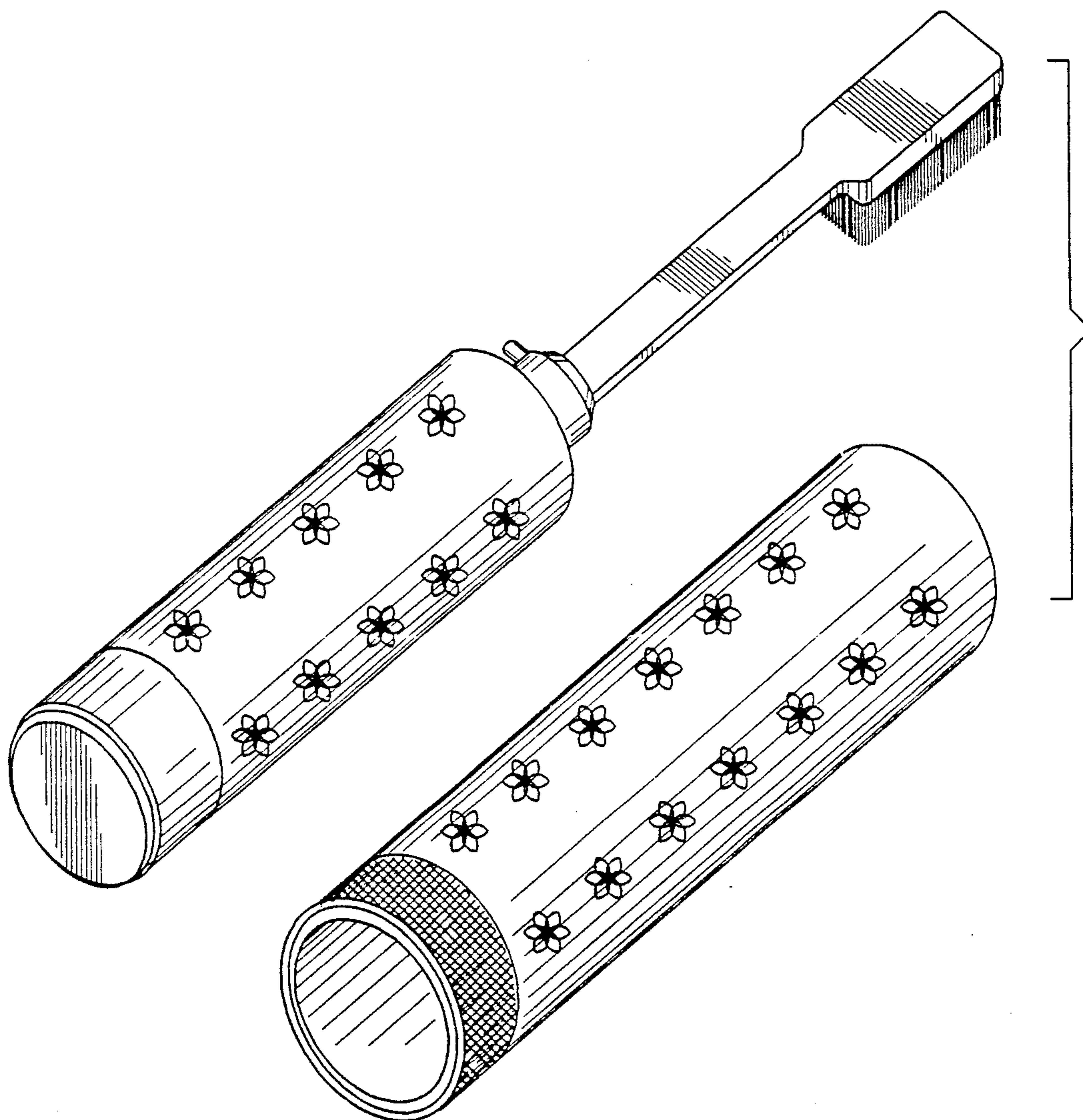

FIG. 8

