



US00D336749S

United States Patent [19]

Lenard et al.

[11] Patent Number: **Des. 336,749**

[45] Date of Patent: **** Jun. 22, 1993**

[54] **HOUSING FOR A BANDSAW SHARPENING MACHINE**

[75] Inventors: **Peter Lenard; Fritz Riehlein**, both of Biberach, Fed. Rep. of Germany

[73] Assignee: **Vollmer Werke Maschinenfabrik GmbH**, Biberach an der Riss, Fed. Rep. of Germany

[**] Term: **14 Years**

[21] Appl. No.: **788,754**

[22] Filed: **Nov. 7, 1991**

[30] **Foreign Application Priority Data**

May 10, 1991 [DE] Fed. Rep. of Germany 9103884
[52] U.S. Cl. **D15/127; D15/133**
[58] Field of Search D15/127, 133; 76/25.1, 76/75, 77, 78, 37, 38, 45

[56] **References Cited**

U.S. PATENT DOCUMENTS

D. 330,032 10/1992 Cromer et al. D15/127

D. 331,066 11/1992 Englert D15/133 X
4,418,589 12/1983 Cowart, Sr. 76/77 X
4,499,794 2/1985 Beck et al. 76/75
5,048,236 9/1991 Williams 76/77 X
5,088,358 2/1992 Emter 76/75

Primary Examiner—Alan P. Douglas
Assistant Examiner—Antoine D. Davis
Attorney, Agent, or Firm—Herbert Dubno; Ronald Lianides

[57] **CLAIM**

The ornamental design for a housing for a bandsaw sharpening machine, as shown.

DESCRIPTION

FIG. 1 is a front, top perspective view of a housing for a bandsaw sharpening machine embodying our new design;
FIG. 2 is a right side elevational view thereof;
FIG. 3 is a front elevational view thereof;
FIG. 4 is a left side elevational view thereof;
FIG. 5 is a rear elevational view thereof; and,
FIG. 6 is a top plan view thereof, the bottom being plain and unornamented.

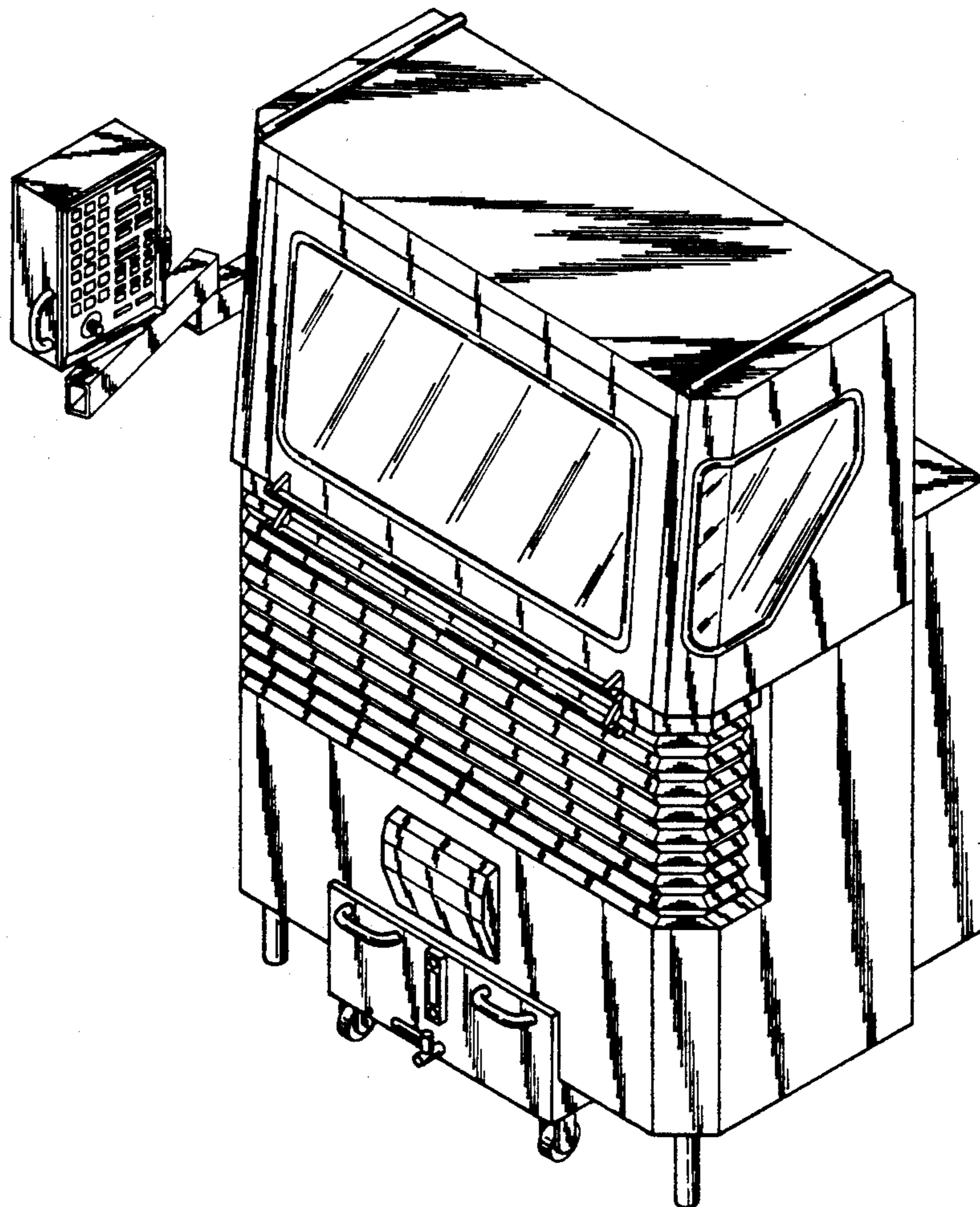

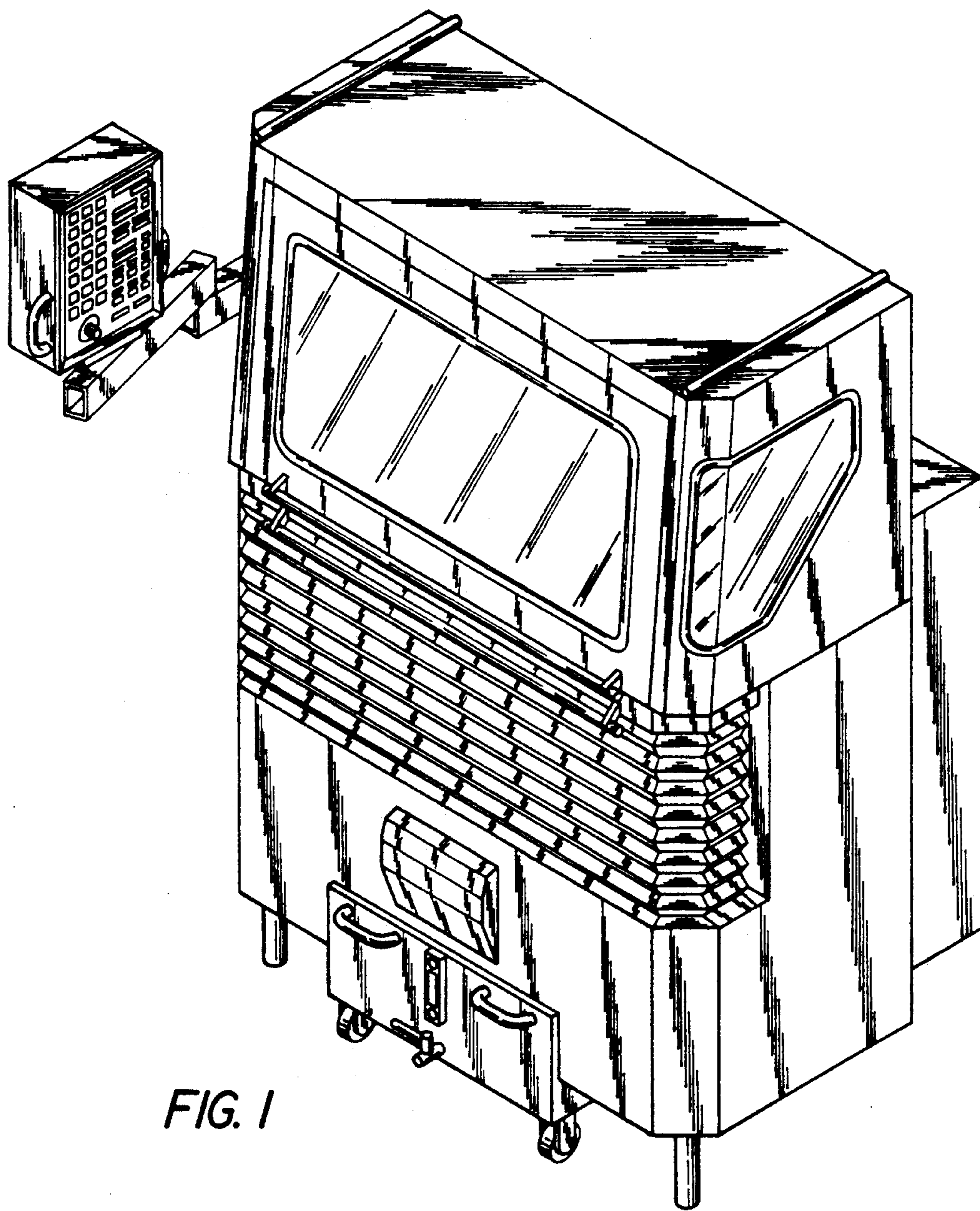

FIG. 1

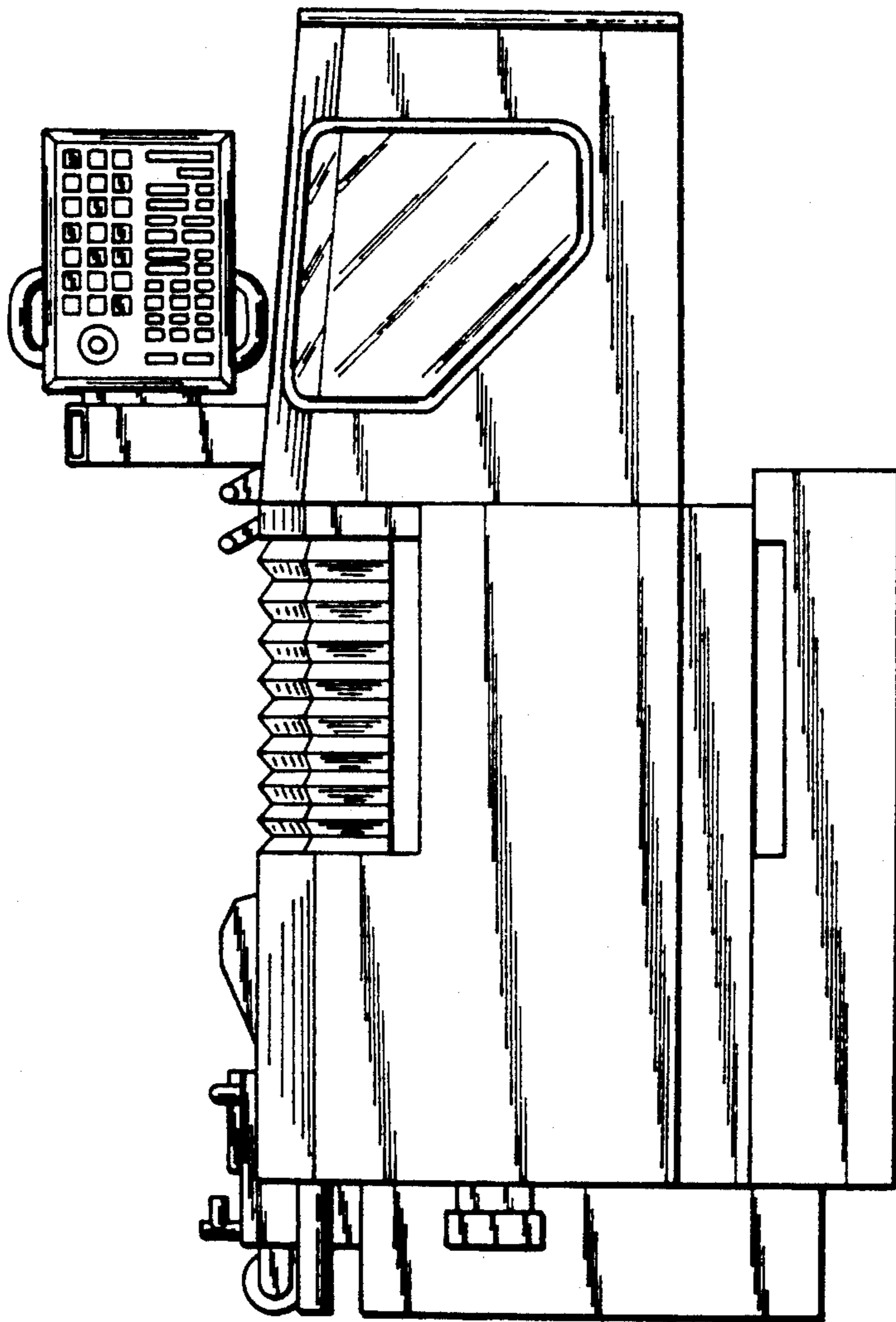

FIG. 2

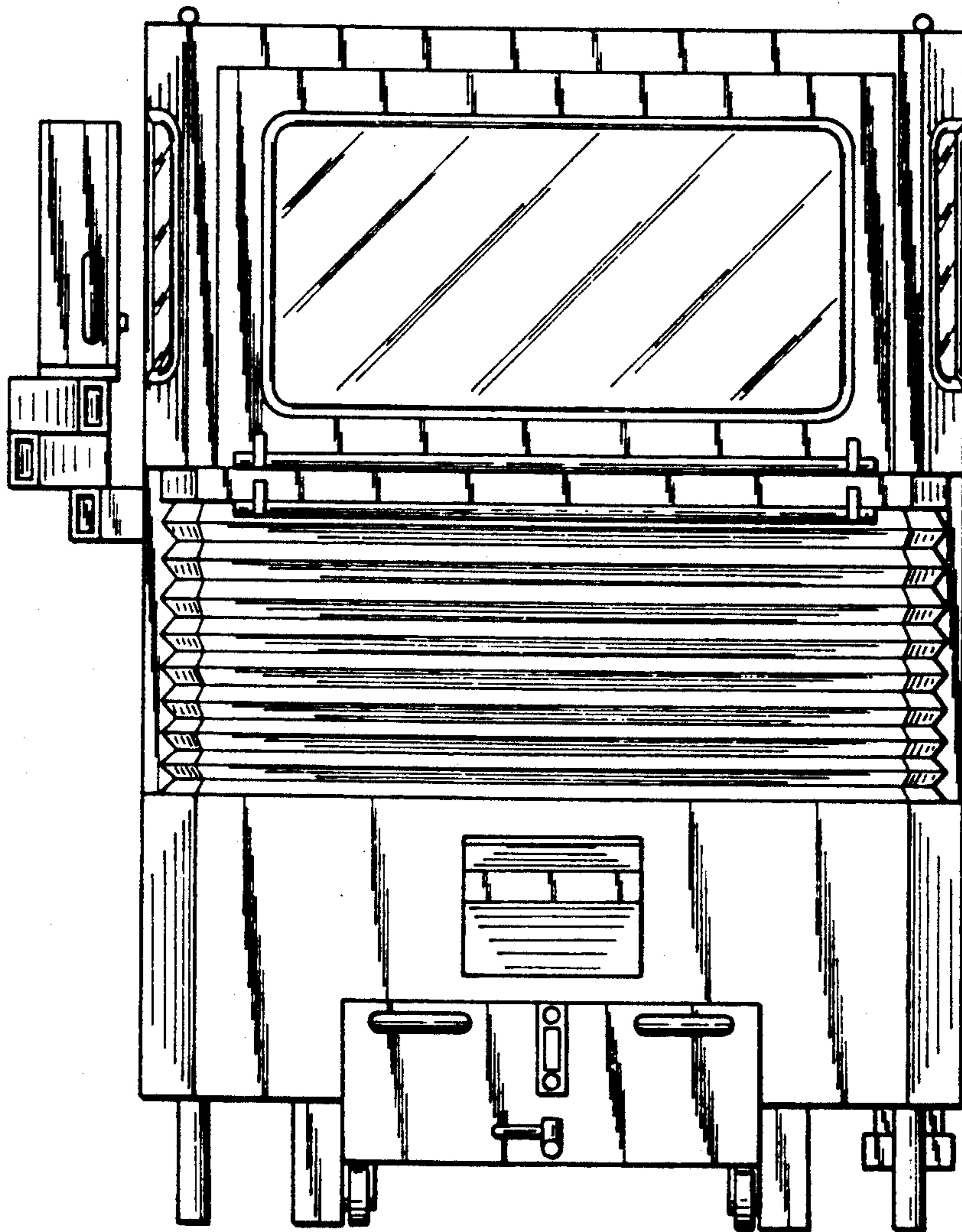

FIG. 3

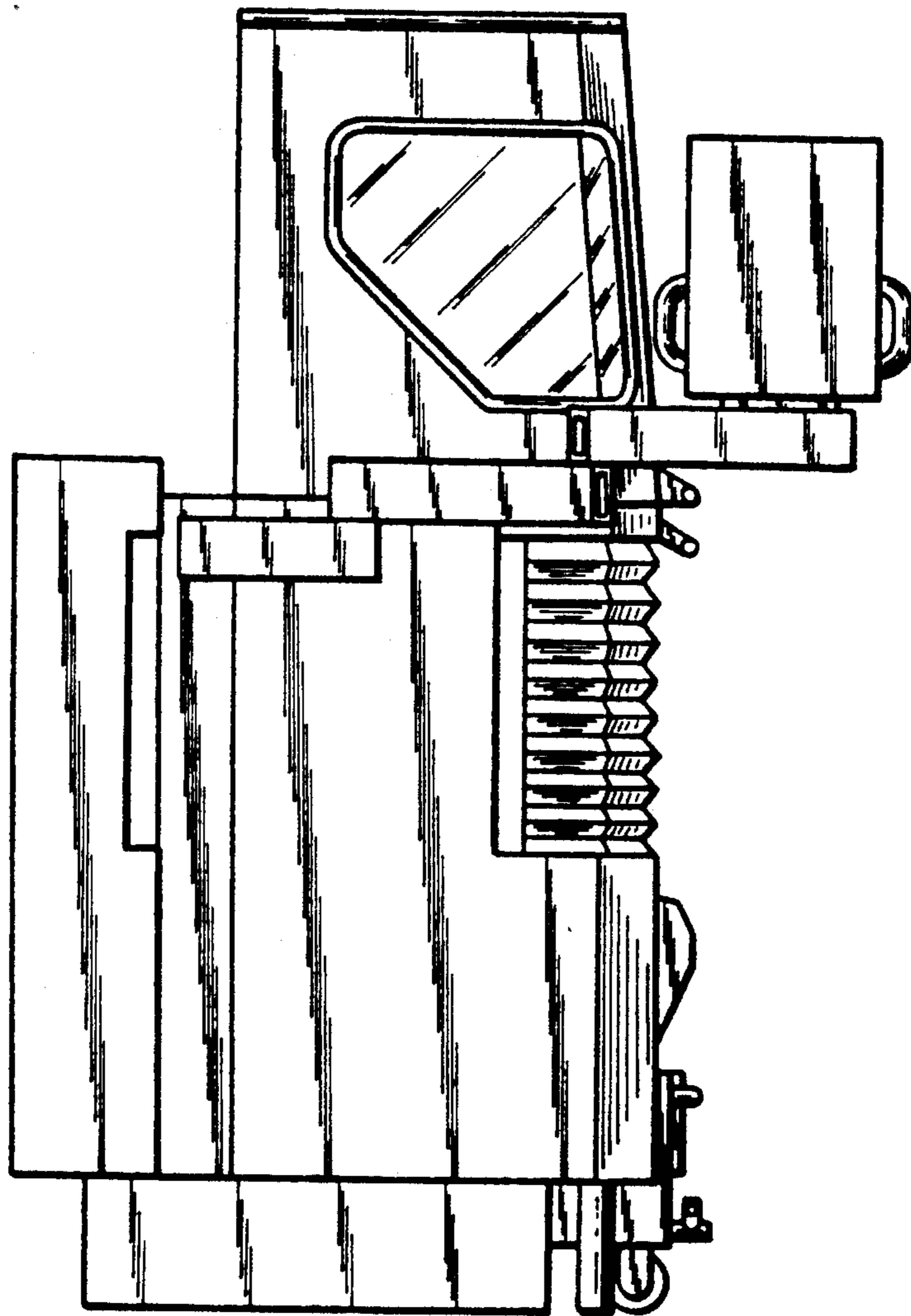

FIG. 4

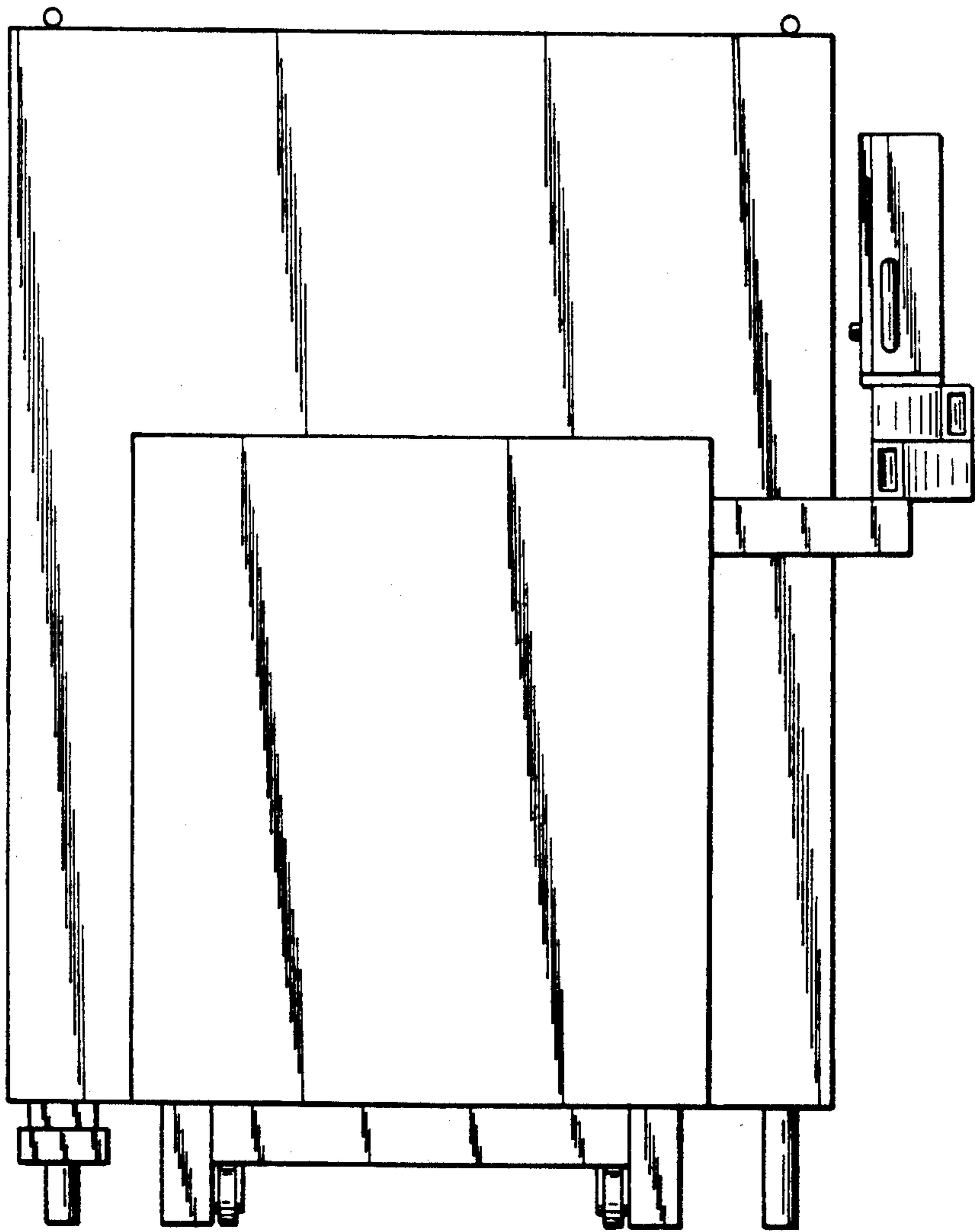

FIG. 5

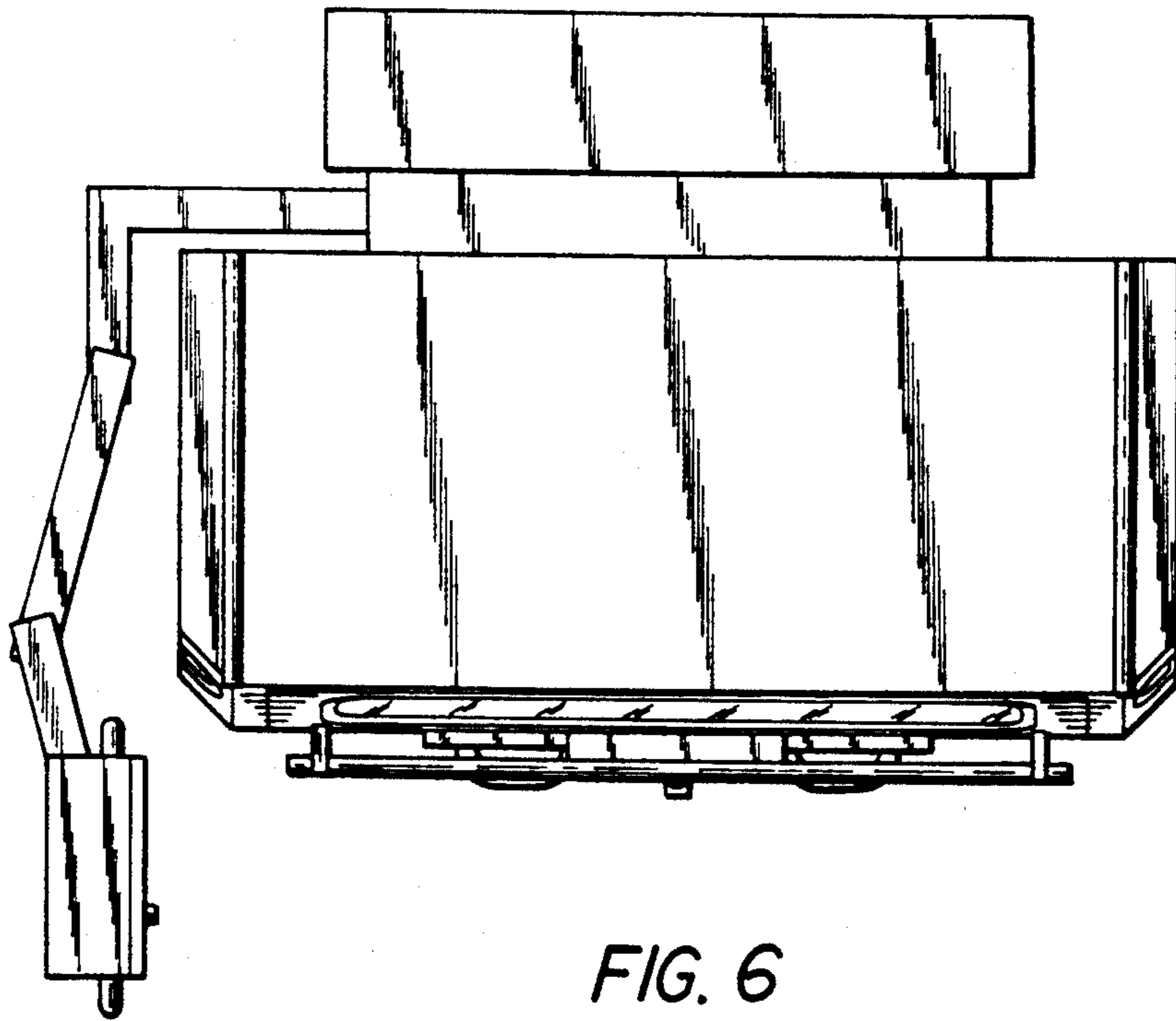

FIG. 6