



US00D336722S

# United States Patent [19]

Fahnstrom et al.

[11] Patent Number: **Des. 336,722**

[45] Date of Patent: **\*\* Jun. 22, 1993**

[54] **CHAIR**

[75] Inventors: **Dale Fahnstrom**, Chicago, Ill.; **Michael McCoy**, Bloomfield Hills, Mich.; **Carl G. Magnusson**, New York City, N.Y.

[73] Assignee: **Westinghouse Electric Corp.**, Pittsburgh, Pa.

[\*\*] Term: **14 Years**

[21] Appl. No.: **463,805**

[22] Filed: **Jan. 11, 1990**

[52] U.S. Cl. .... **D6/366**

[58] Field of Search ..... **D6/366; 297/DIG. 1, 297/DIG. 2, DIG. 3, 183, 184, 192, 194, 357, 411, 415, 417, 418, 421, 440, 468**

[56] **References Cited**

**U.S. PATENT DOCUMENTS**

D. 252,781	9/1979	Ball .....	D6/366
D. 320,704	10/1991	Monesi .....	D6/366
3,947,068	3/1976	Buhk .	
4,754,364	6/1988	Speet et al. .	

**OTHER PUBLICATIONS**

*Domus*, Supplementary Issue, Dec. 1979, p. 28, "Chair," left center of page.

*Domus*, Dec. 1987, p. 689, "Chair", center of page.

*Girsherger Trilax 1 Cat*, p. 1, "Design of Chair-F. Makiol," left center of page.

*Interiors*, Oct. 1977, p. 26, "KD Chair," top center of page.

*Primary Examiner*—Alan P. Douglas

*Assistant Examiner*—Monica A. Hannon

*Attorney, Agent, or Firm*—B. R. Studebaker

[57] **CLAIM**

An ornamental design for a chair, as shown and described.

**DESCRIPTION**

FIG. 1 is a front perspective view of a chair showing our new design;

FIG. 2 is a front elevational view thereof;

FIG. 3 is a right side elevational view thereof;

FIG. 4 is a rear elevational view thereof;

FIG. 5 is a left side elevational view thereof;

FIG. 6 is a top plan view thereof; and,

FIG. 7 is a bottom plan view thereof.

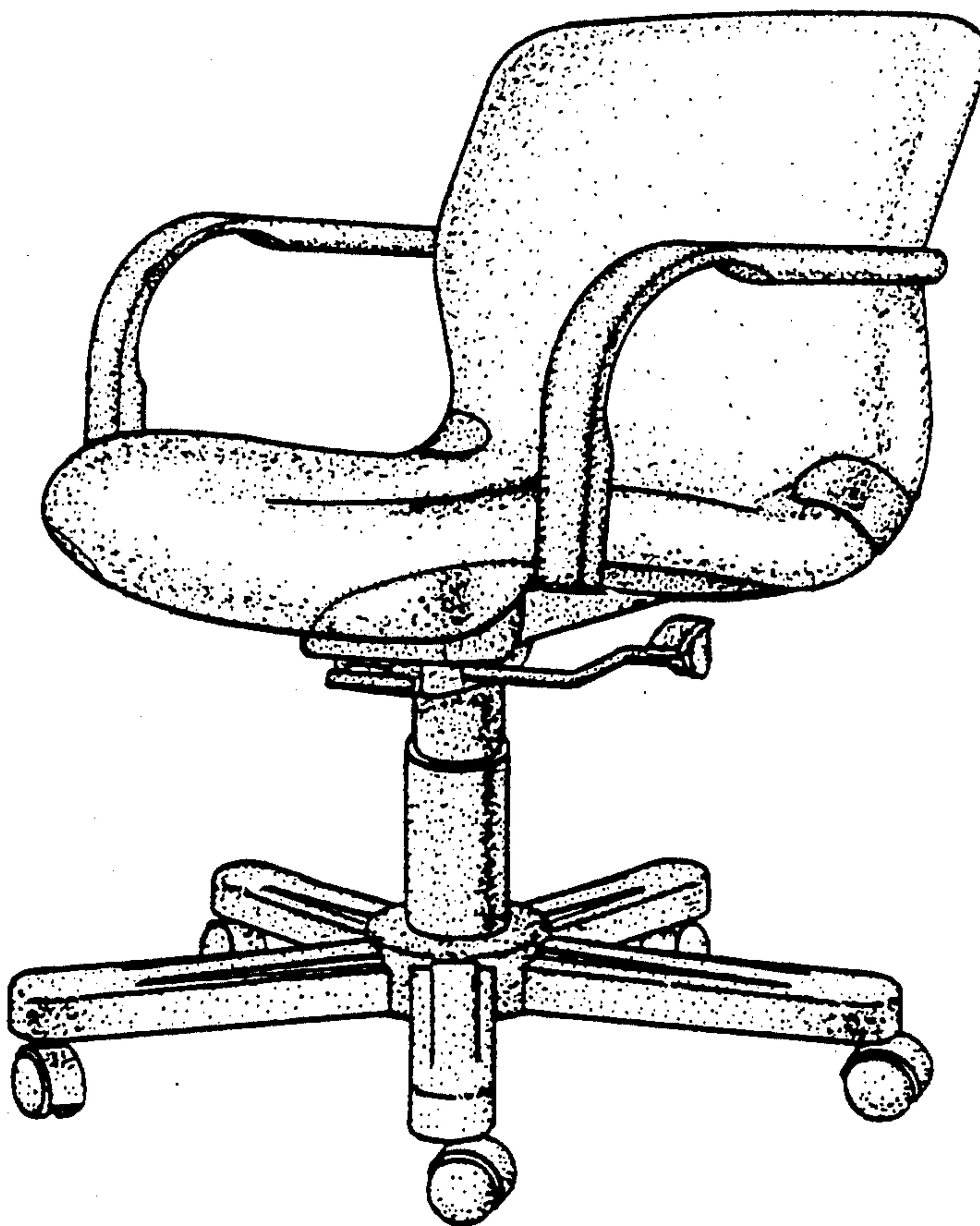

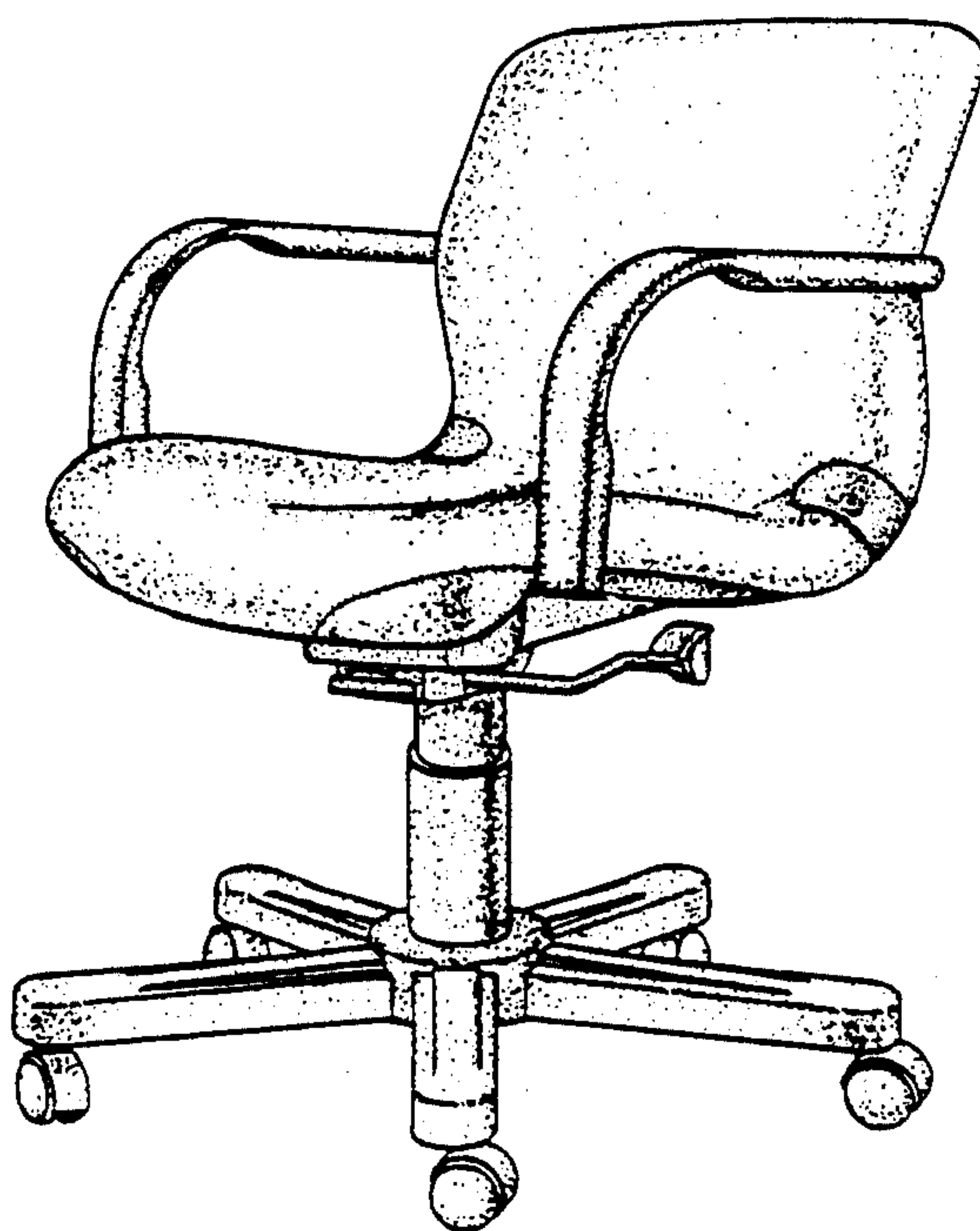

FIG. 1

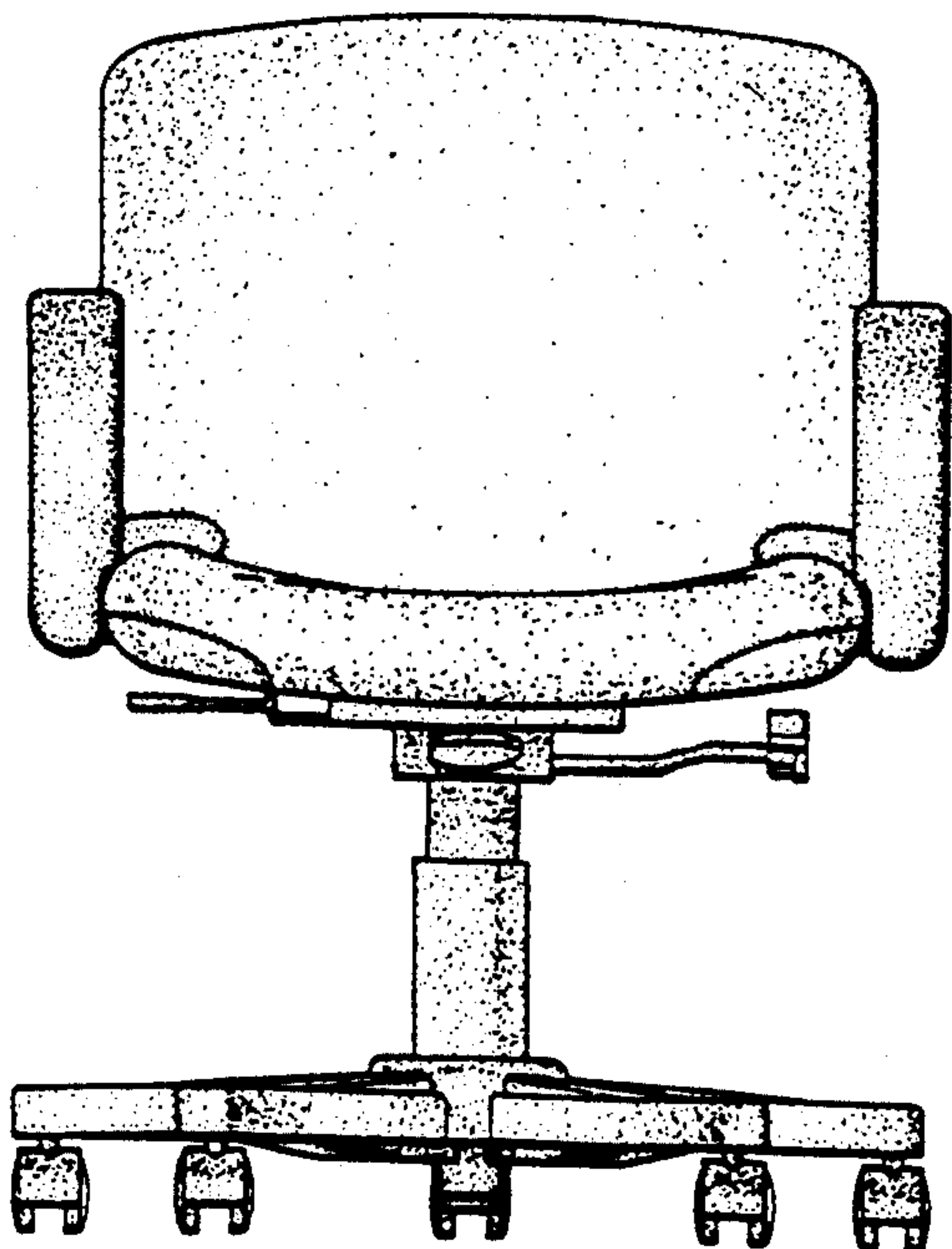

FIG. 2

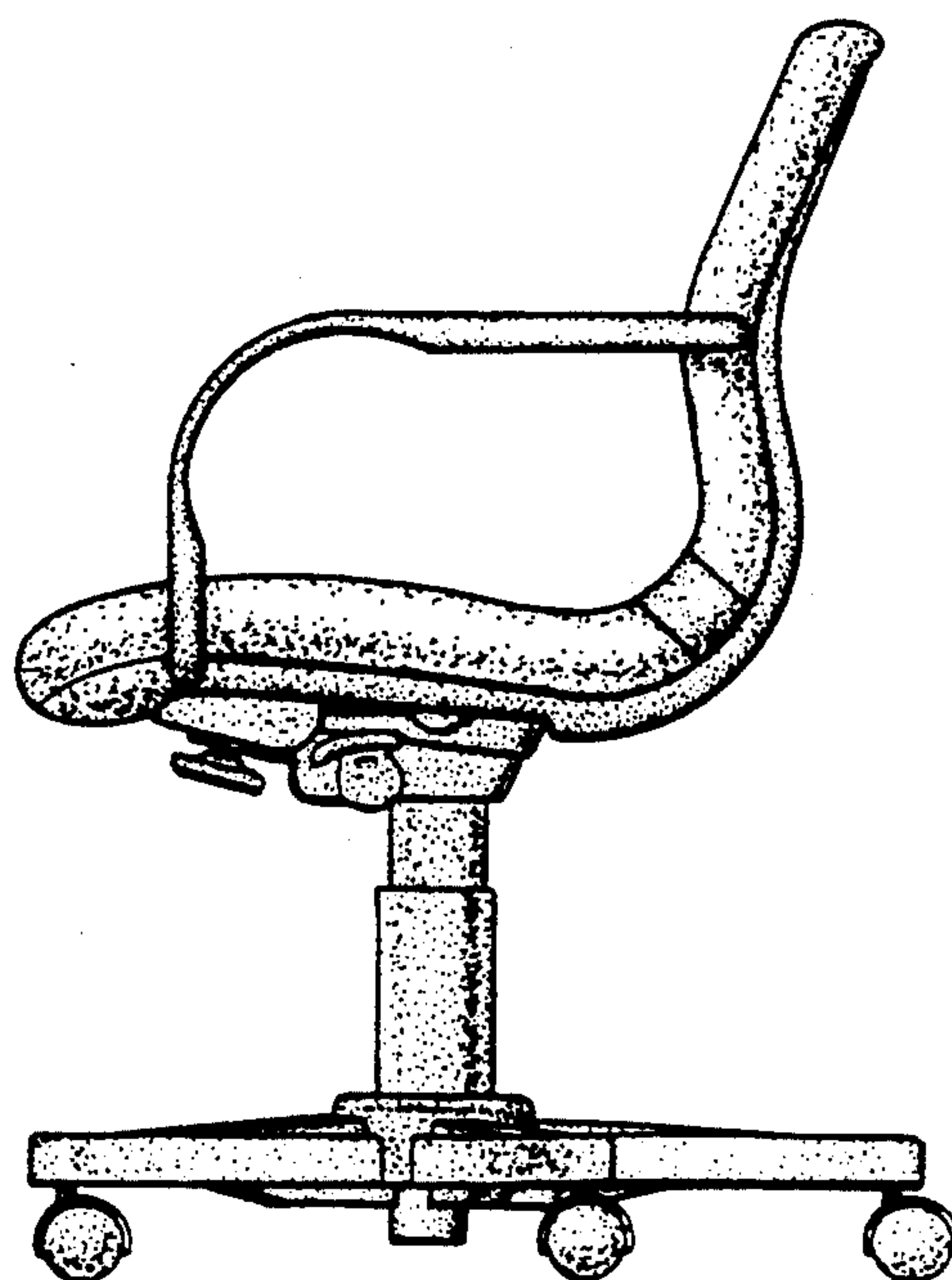

FIG. 3



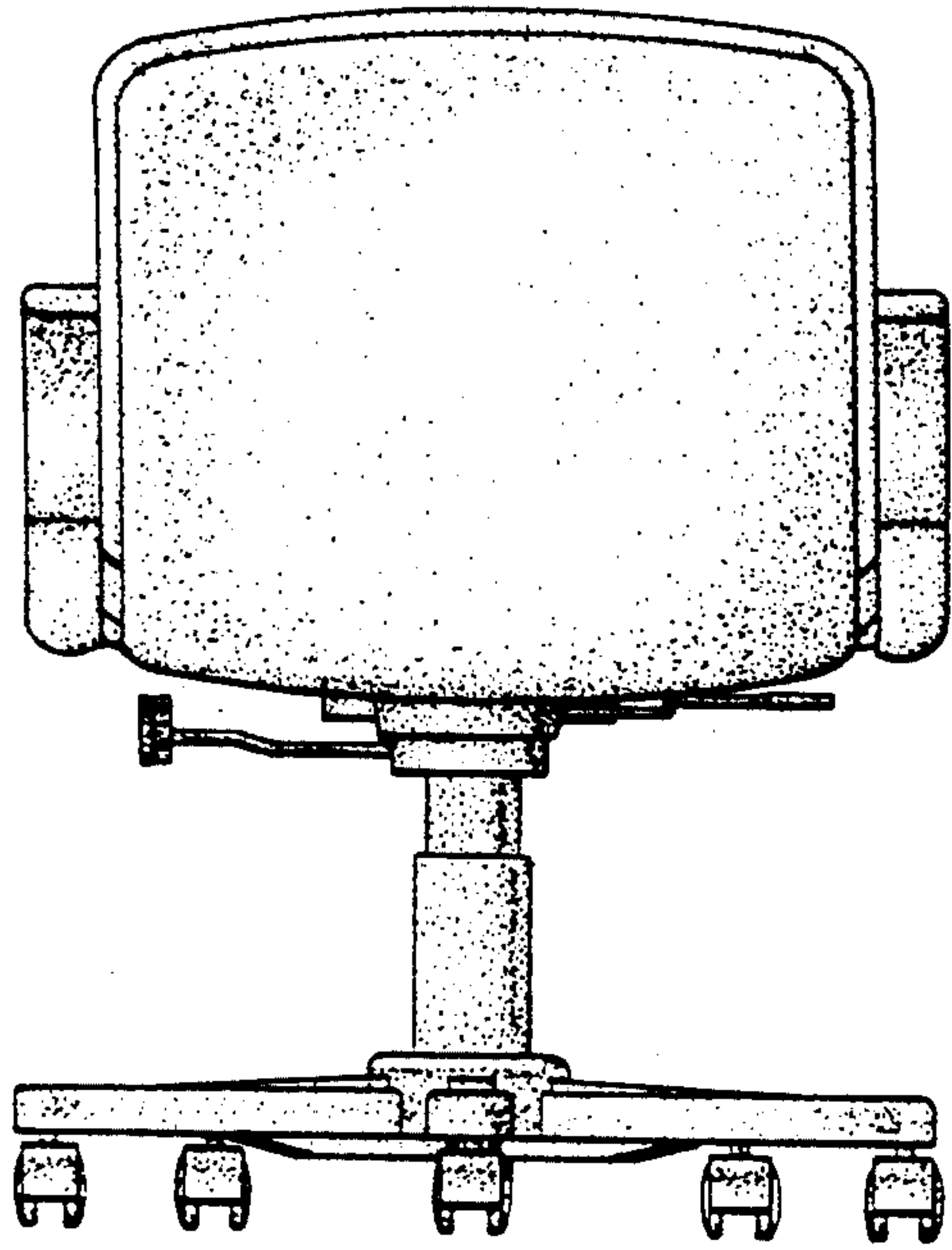

FIG. 4

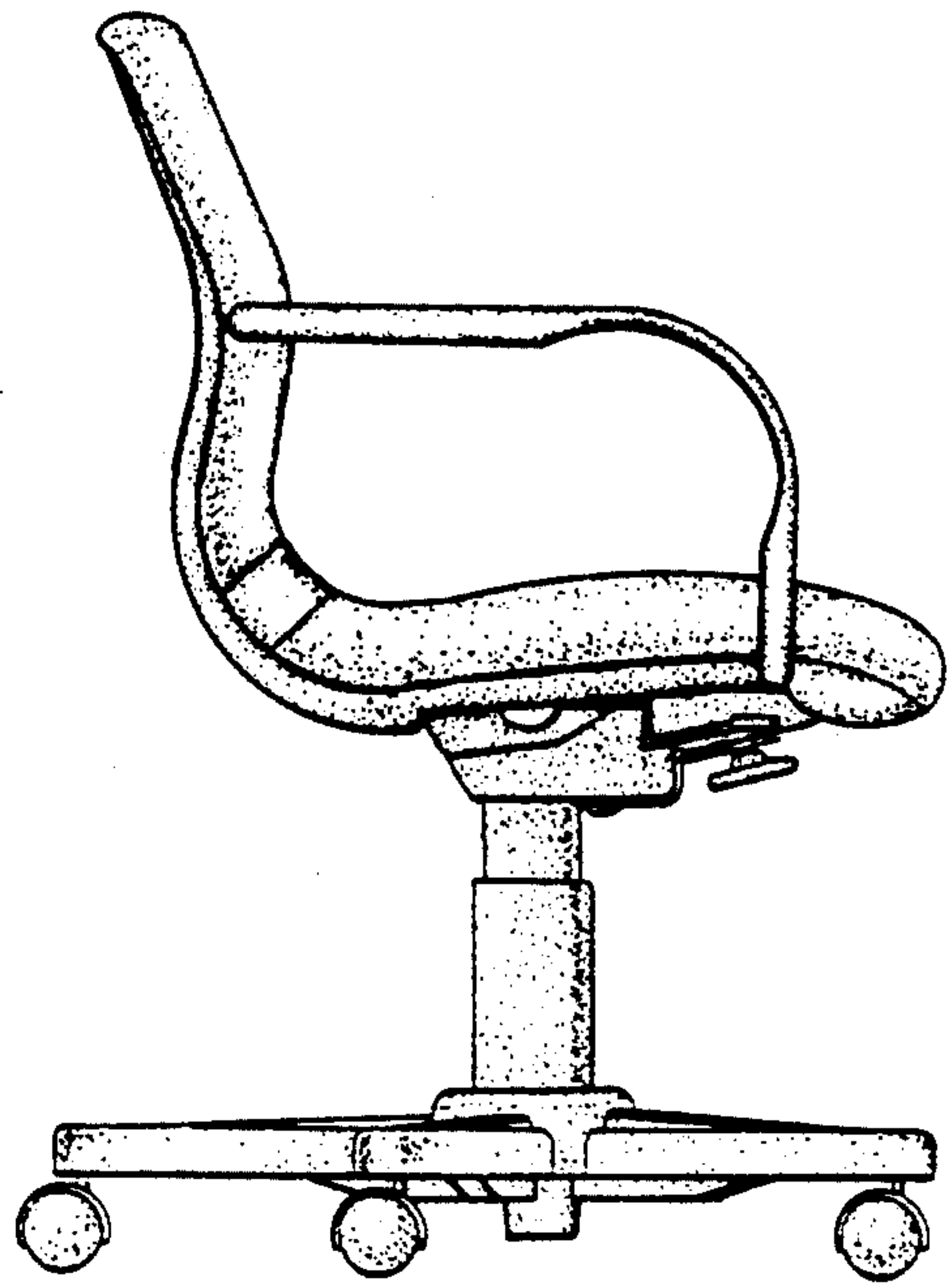

FIG. 5

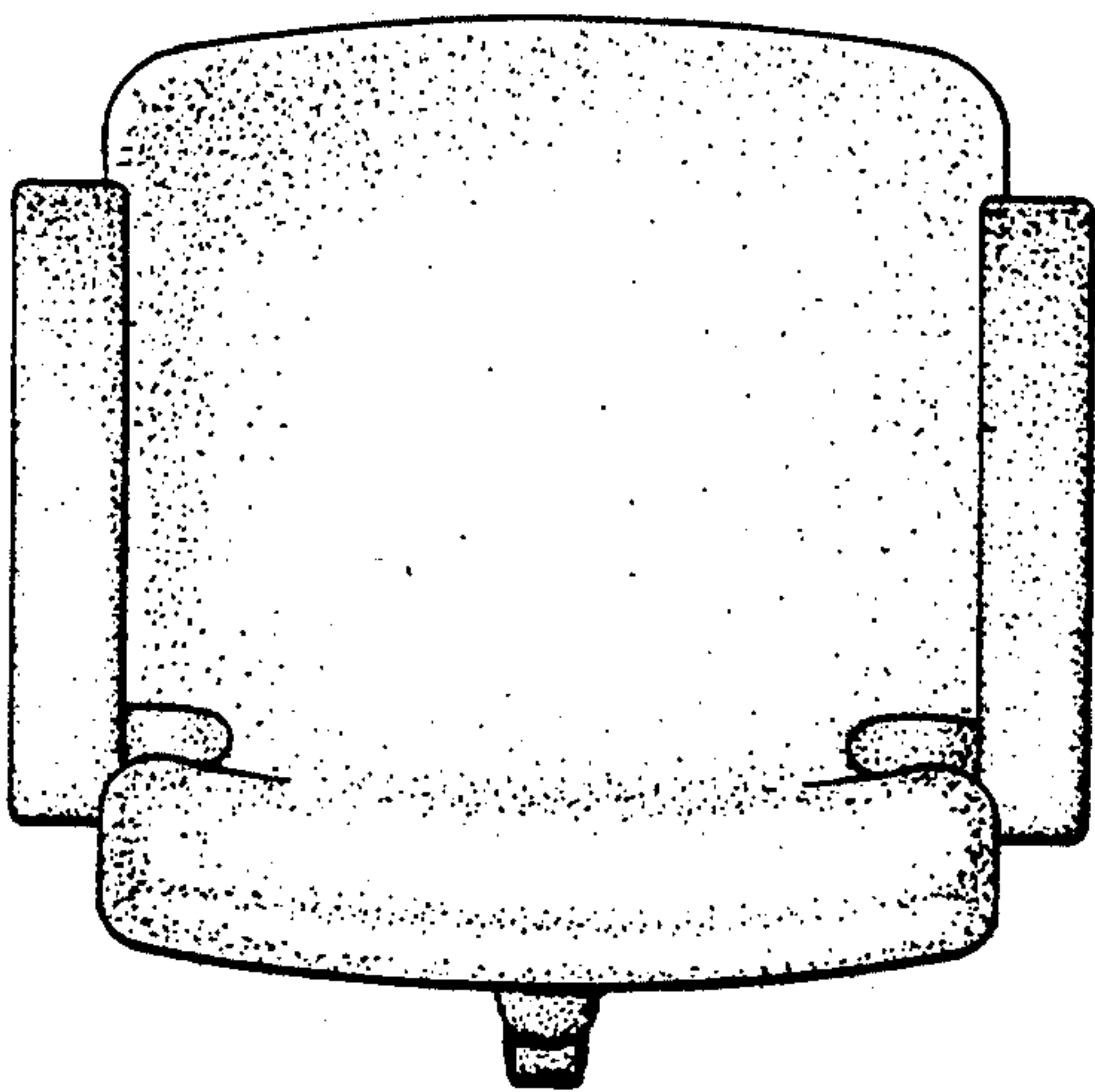

FIG. 6

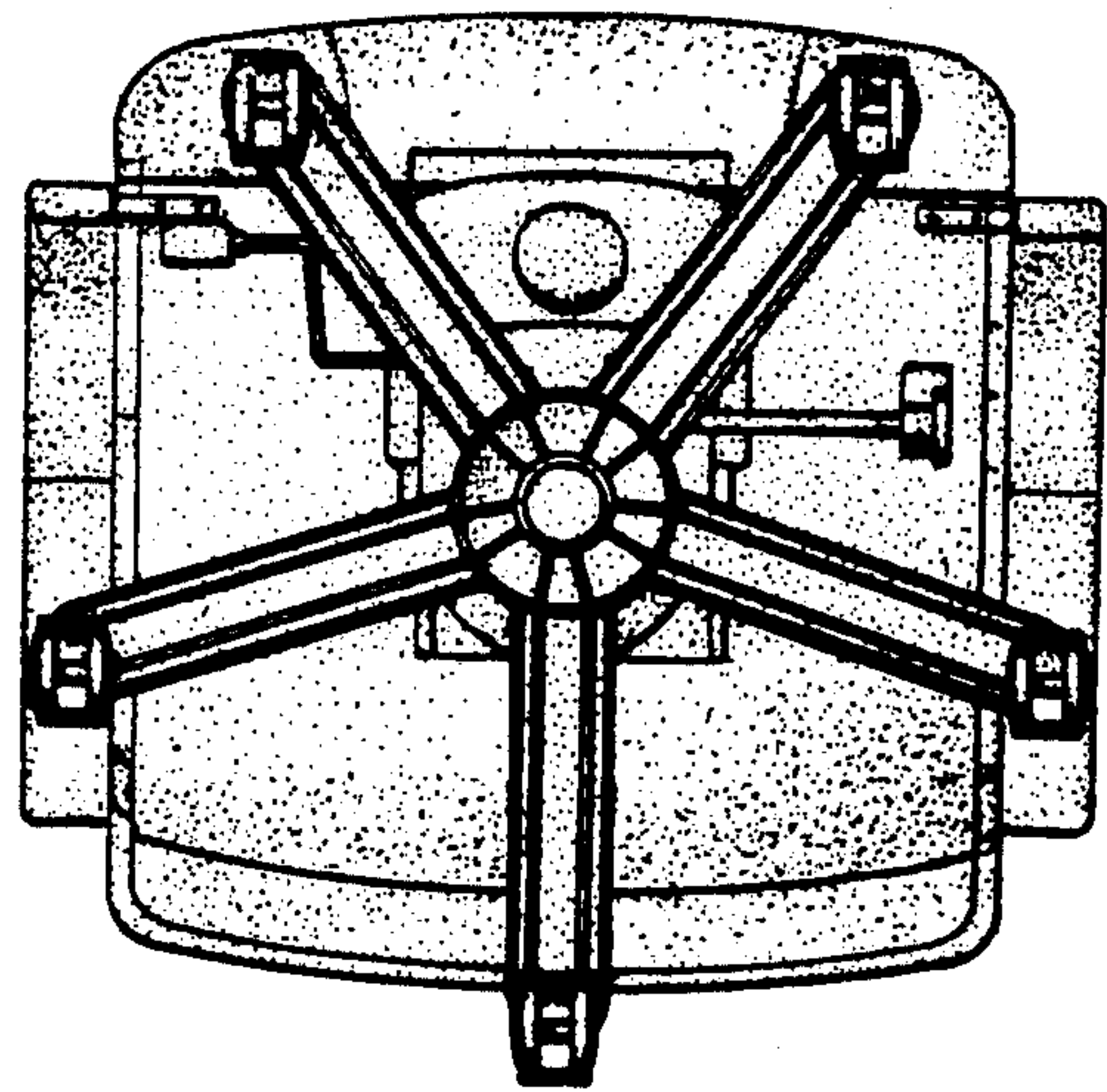

FIG. 7