



US00D336672S

United States Patent [19]

[11] Patent Number: **Des. 336,672**

Gorman

[45] Date of Patent: **** Jun. 22, 1993**

[54] **GOLF CLUB IRON HEAD** 4,826,172 5/1989 Antonious 273/169
 4,907,806 3/1990 Antonious 273/
 [75] Inventor: **Geoffrey W. Gorman, Greer, S.C.** 4,921,252 5/1990 Antonious .
 4,938,470 7/1990 Antonious .
 [73] Assignee: **Dunlop Slazenger Corporation,** 5,048,834 9/1991 Gorman .
Greenville, S.C. 5,048,835 9/1991 Gorman .
 5,074,563 12/1991 Gorman 273/
 [**] Term: **14 Years**

[21] Appl. No.: **627,619**
 [22] Filed: **Dec. 12, 1990**
 [52] U.S. Cl. **D21/220**
 [58] Field of Search **D21/214-220;**
273/164, 167-175

- [56] **References Cited**
U.S. PATENT DOCUMENTS
- D. 229,434 11/1973 Lrower D34/5 GN
 - D. 267,965 2/1983 Kobayashi D21/220
 - D. 320,056 9/1991 Antonious D21/220
 - 2,087,685 7/1937 Hackney 273/77
 - 2,691,525 10/1954 Callaghan, Sr. .
 - 2,846,228 8/1958 Reach 273/169
 - 3,814,437 6/1974 Winqvist 273/167 R
 - 4,128,244 12/1978 Duclos 273/164
 - 4,136,877 1/1979 Antonious 273/164
 - 4,325,553 4/1985 Taylor 273/167 F
 - 4,326,326 4/1982 MacDonald .
 - 4,355,808 10/1982 Jernigan 273/169
 - 4,508,350 4/1985 Duclos 273/183
 - 4,511,145 4/1985 Schmidt 273/167 H
 - 4,569,523 2/1986 Jarvis 273/164
 - 4,621,813 11/1986 Solheim 273/77 A

OTHER PUBLICATIONS

Golf Digest, Jan., 1989, p. 37, Golf Club.
Primary Examiner—Melvin B. Feifer
Attorney, Agent, or Firm—Lorusso & Loud

CLAIM

[57] The ornamental design for a golf club iron head, as shown and described.

DESCRIPTION

FIG. 1 is a front elevational view of a golf club iron head showing a first embodiment of my new design; FIG. 2 is a rear elevational view thereof; FIG. 3 is a top view thereof; FIG. 4 is a bottom view thereof; FIG. 5 is a toe end view thereof; FIG. 6 is a heel end view thereof; FIG. 7 is a front elevational view showing a second embodiment of my new design; FIG. 8 is a rear elevational view thereof; FIG. 9 is a top view thereof; FIG. 10 is a bottom view thereof; FIG. 11 is a toe end view thereof; and, FIG. 12 is a heel end view thereof.

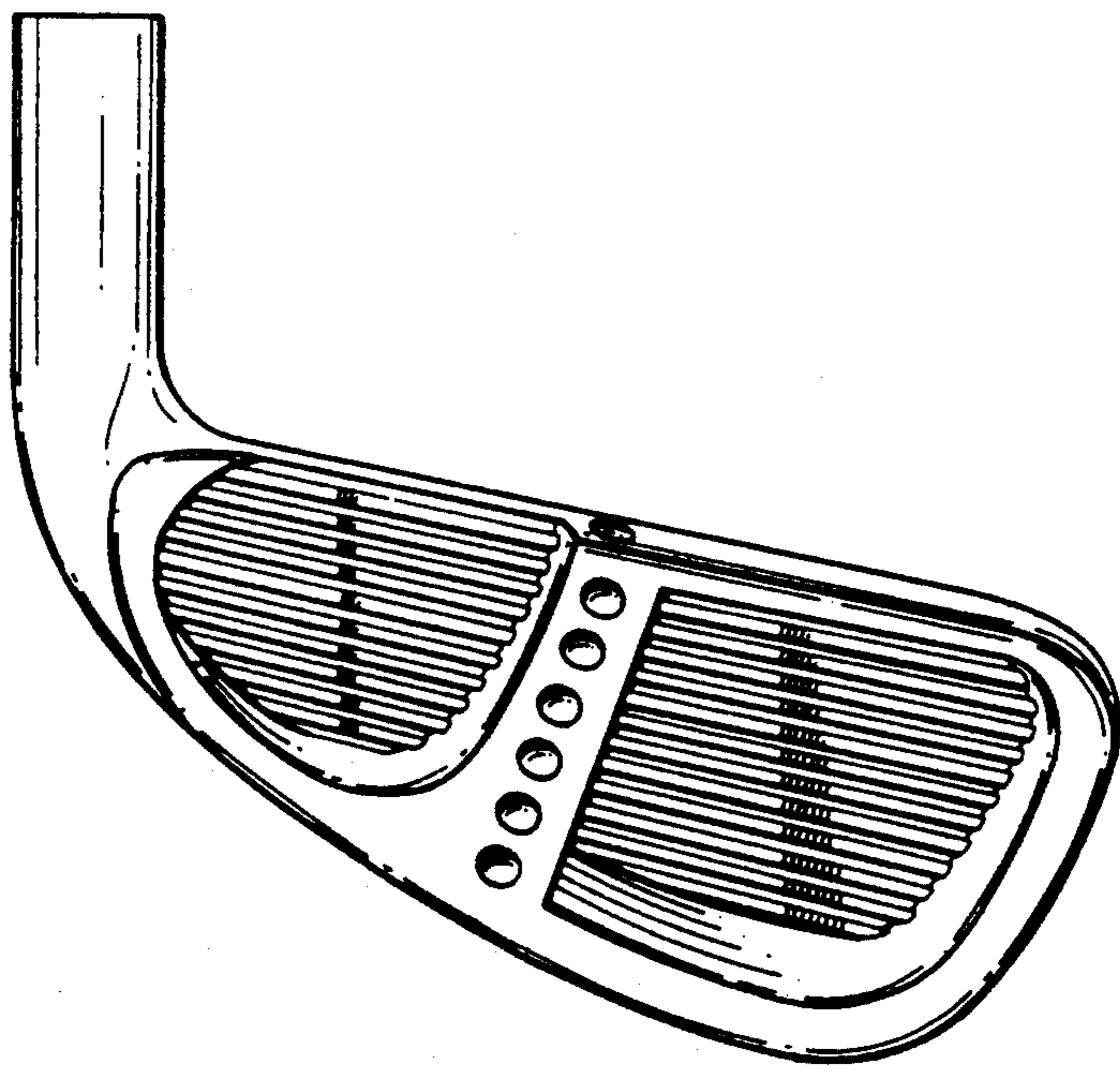

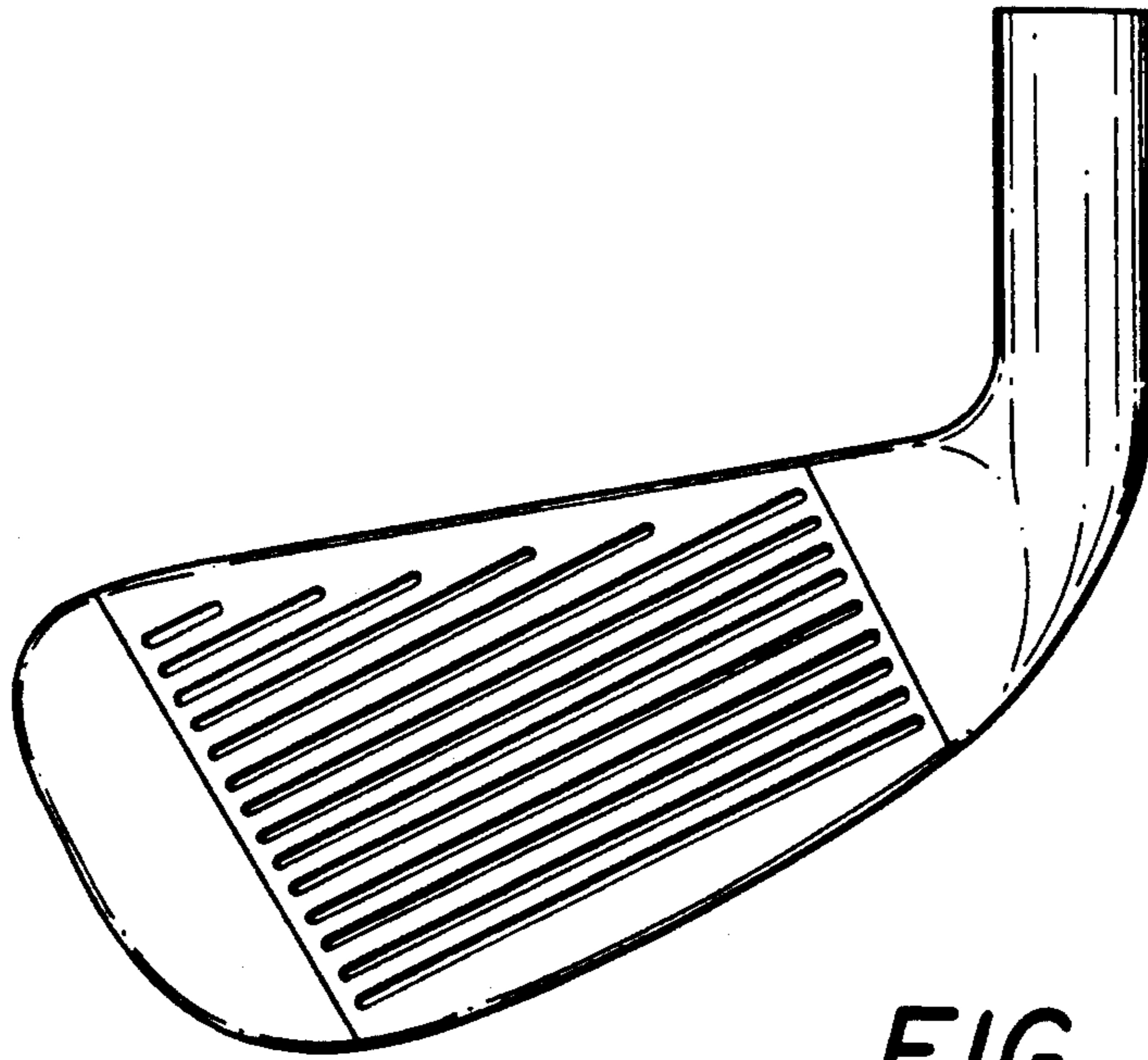

FIG. 1

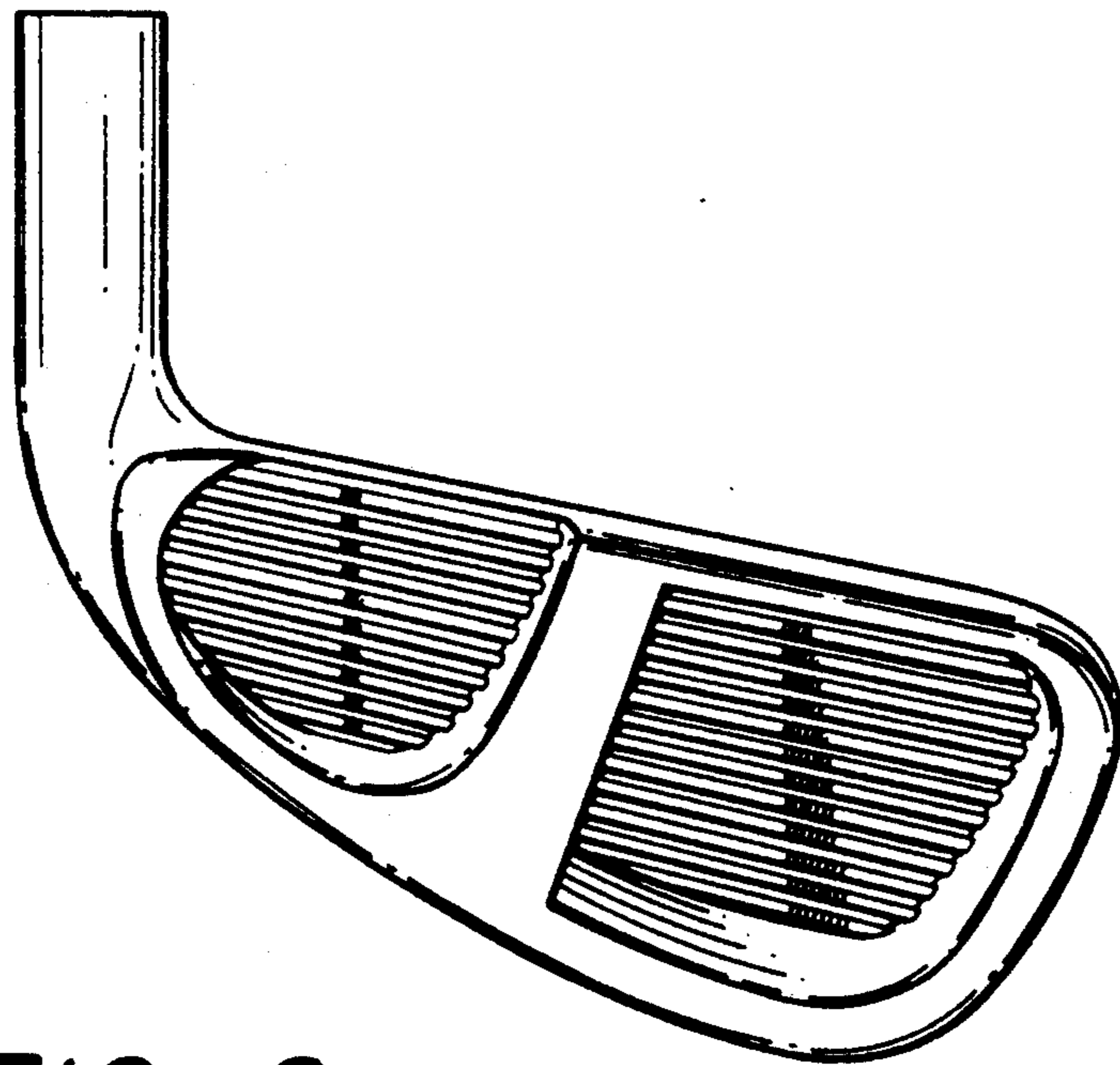

FIG. 2

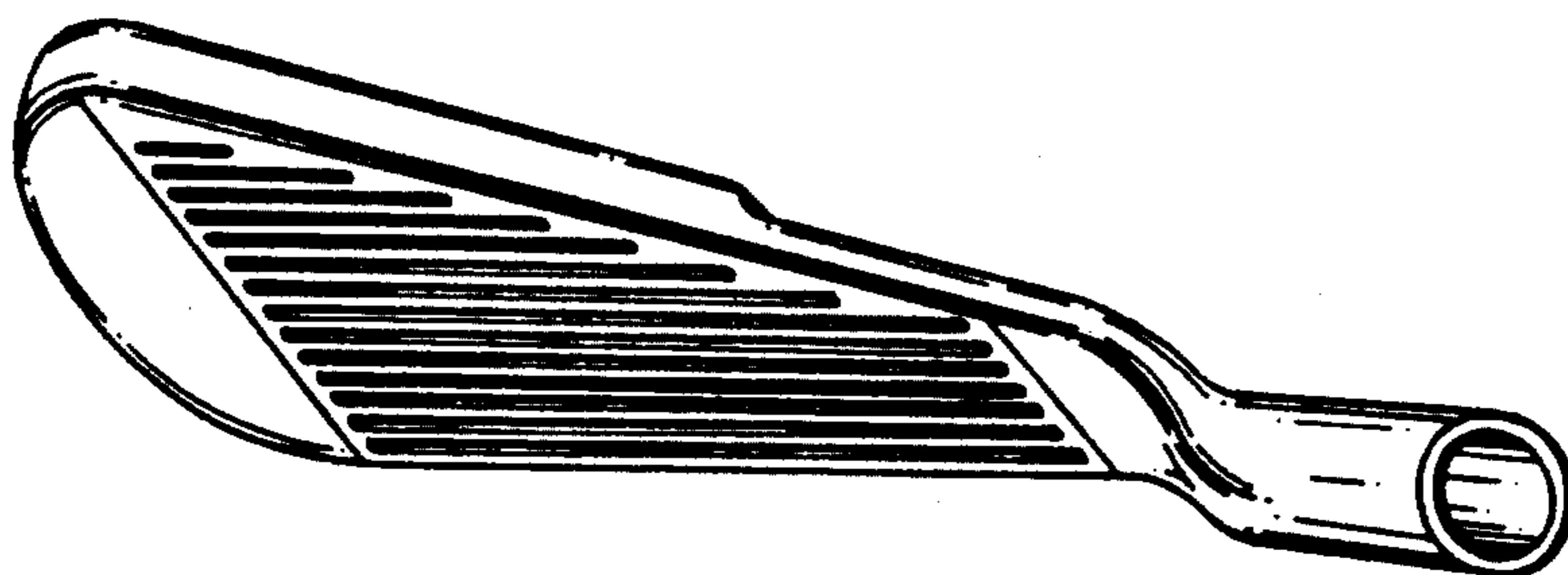

FIG. 3

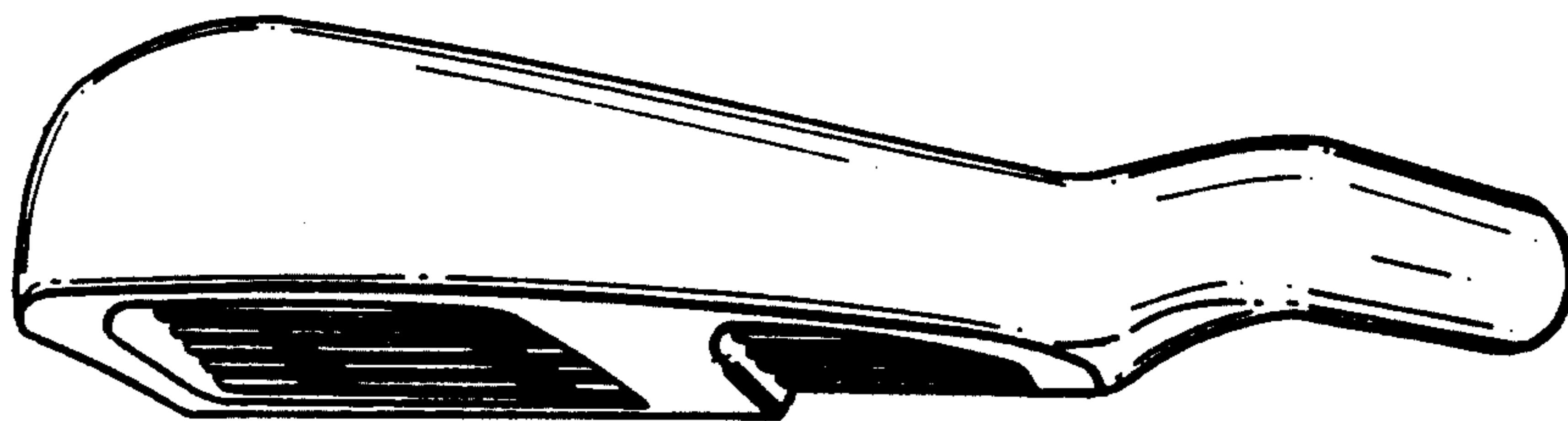

FIG. 4

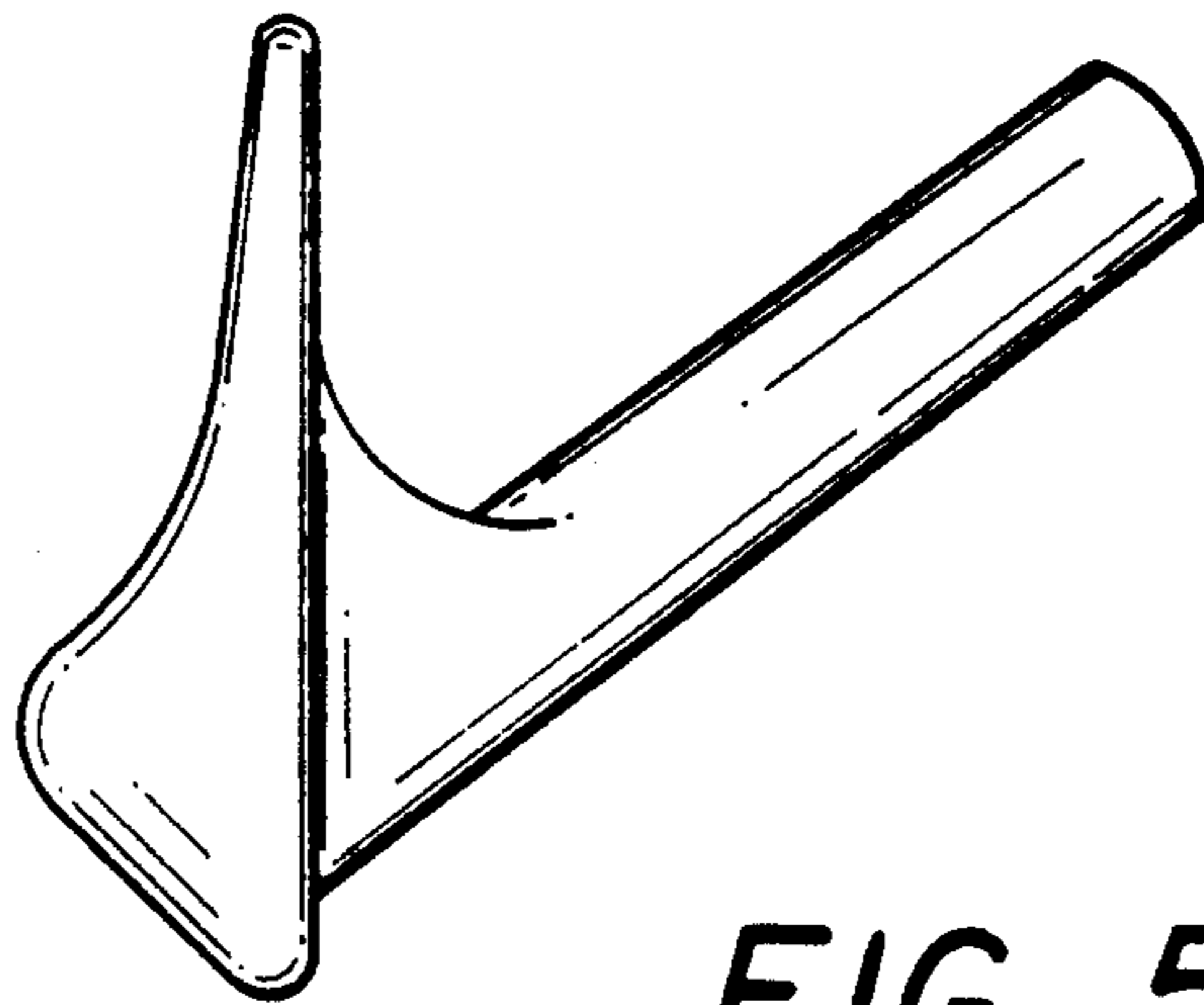

FIG. 5

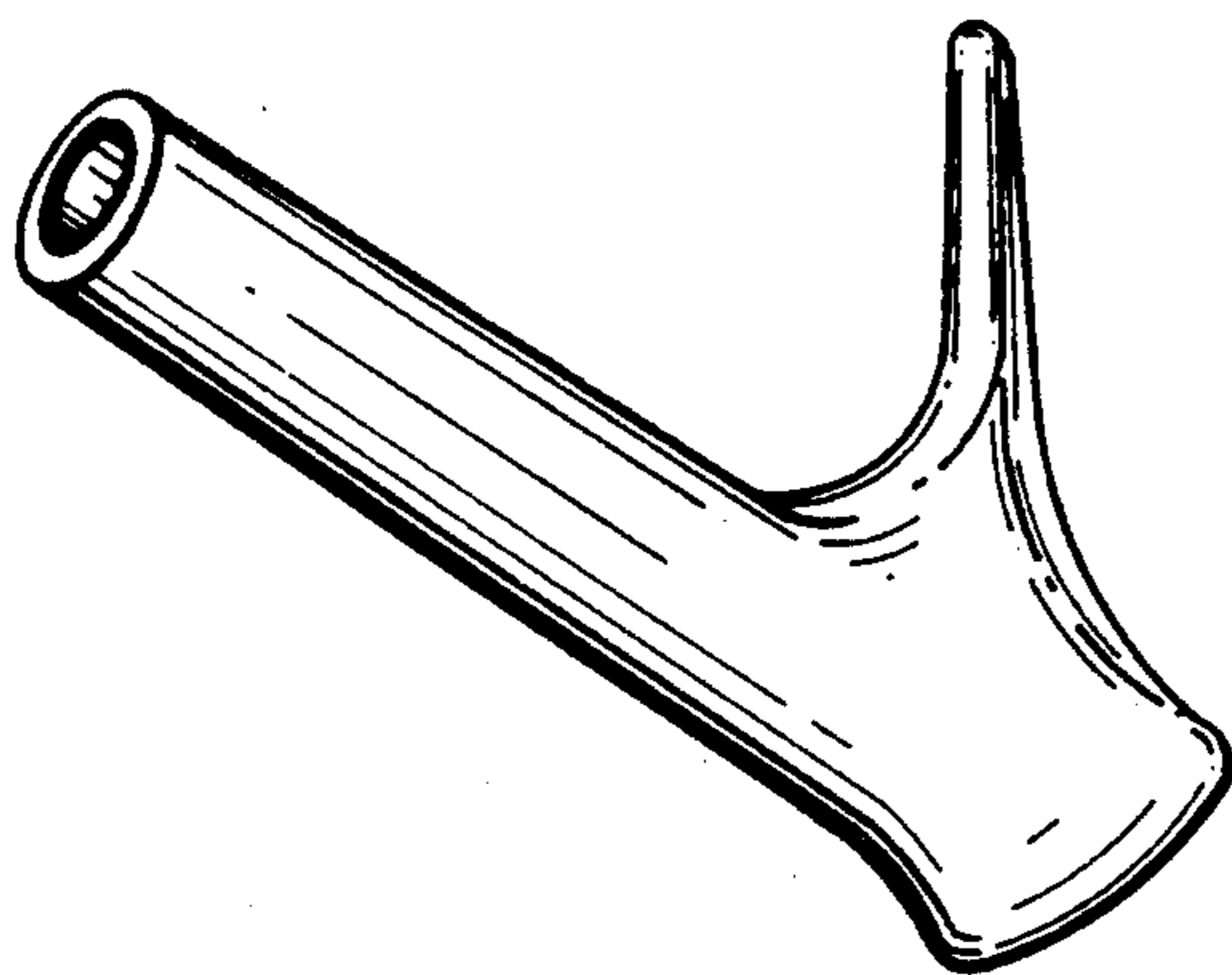

FIG. 6

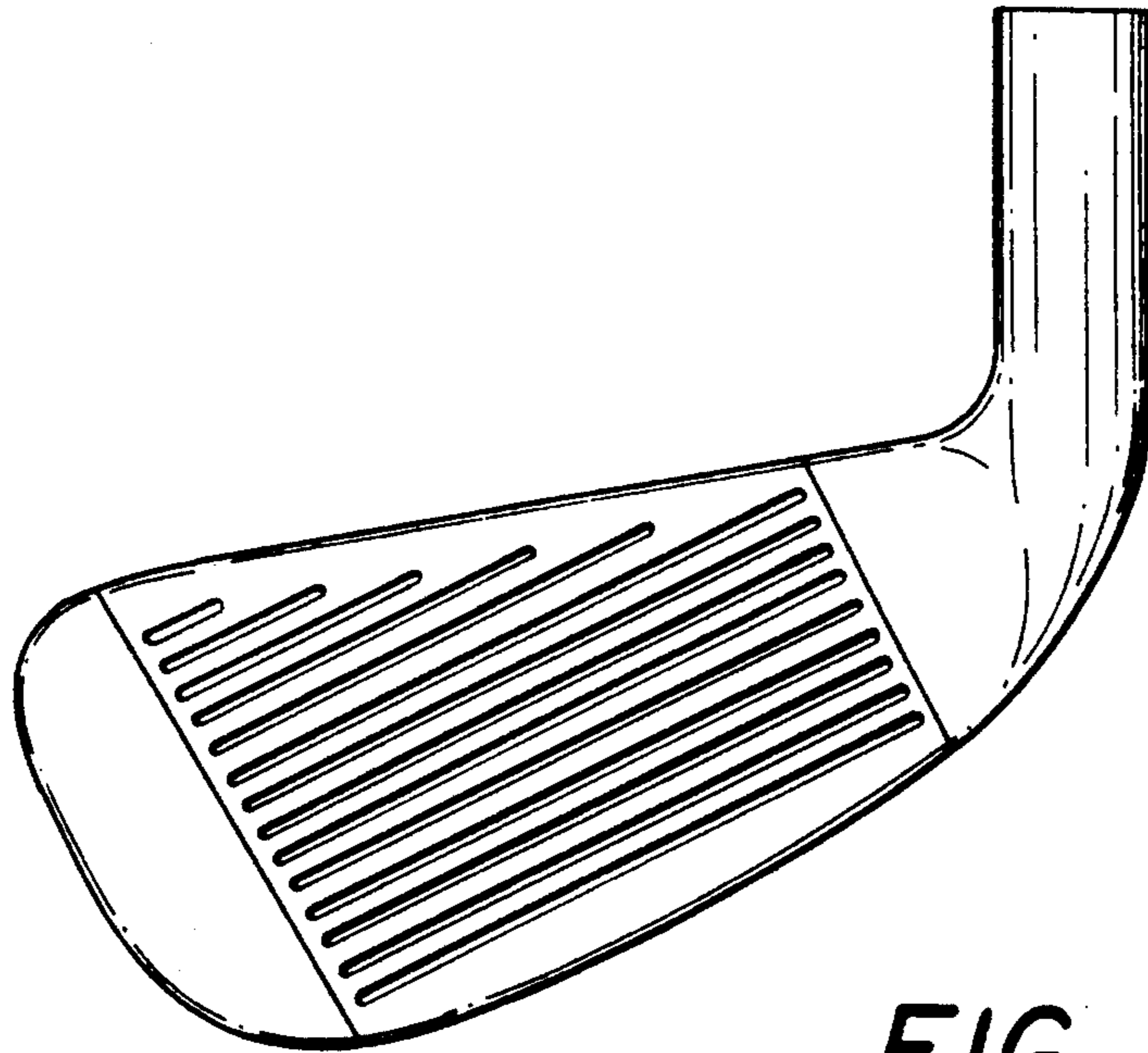

FIG. 7

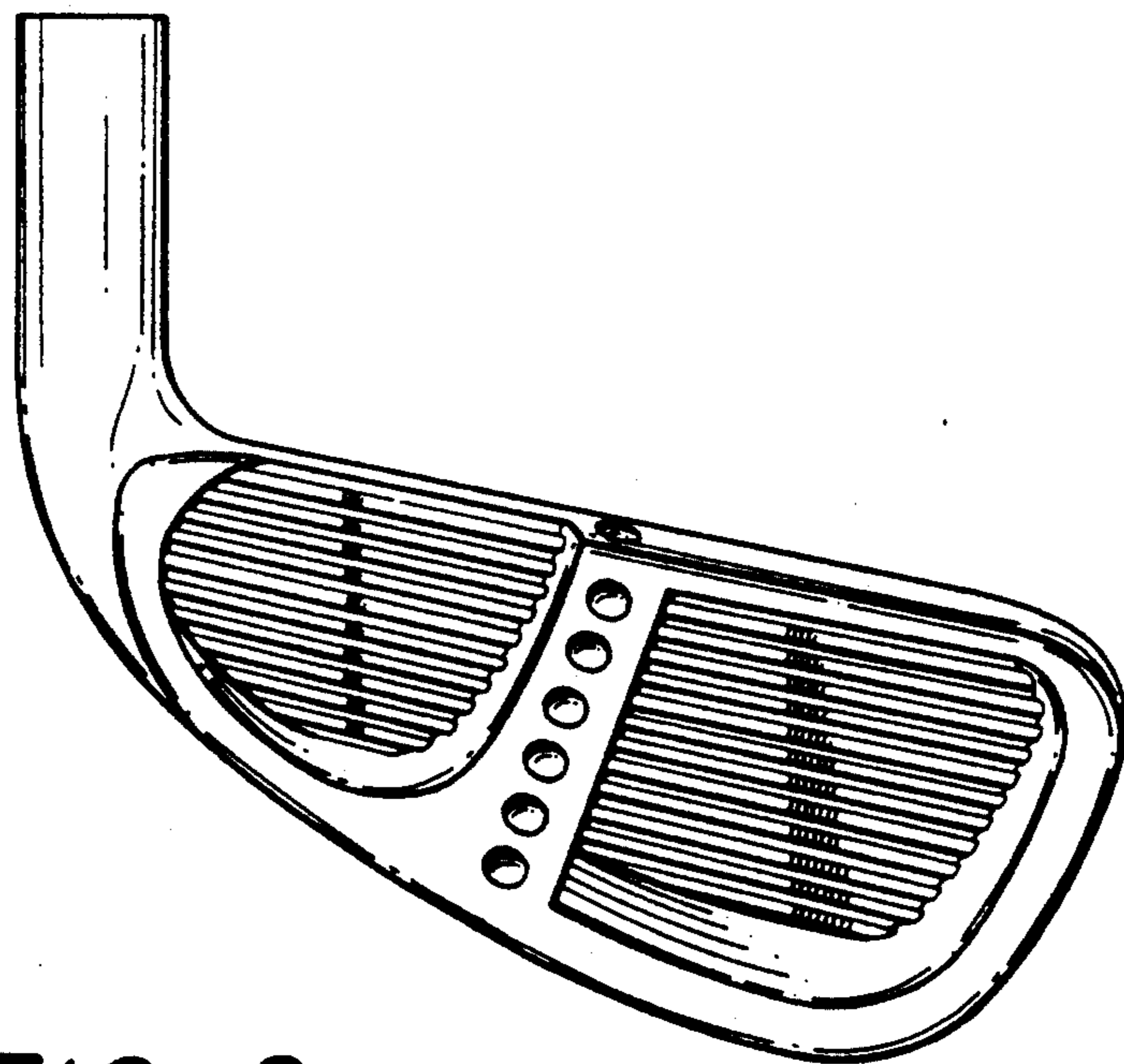

FIG. 8

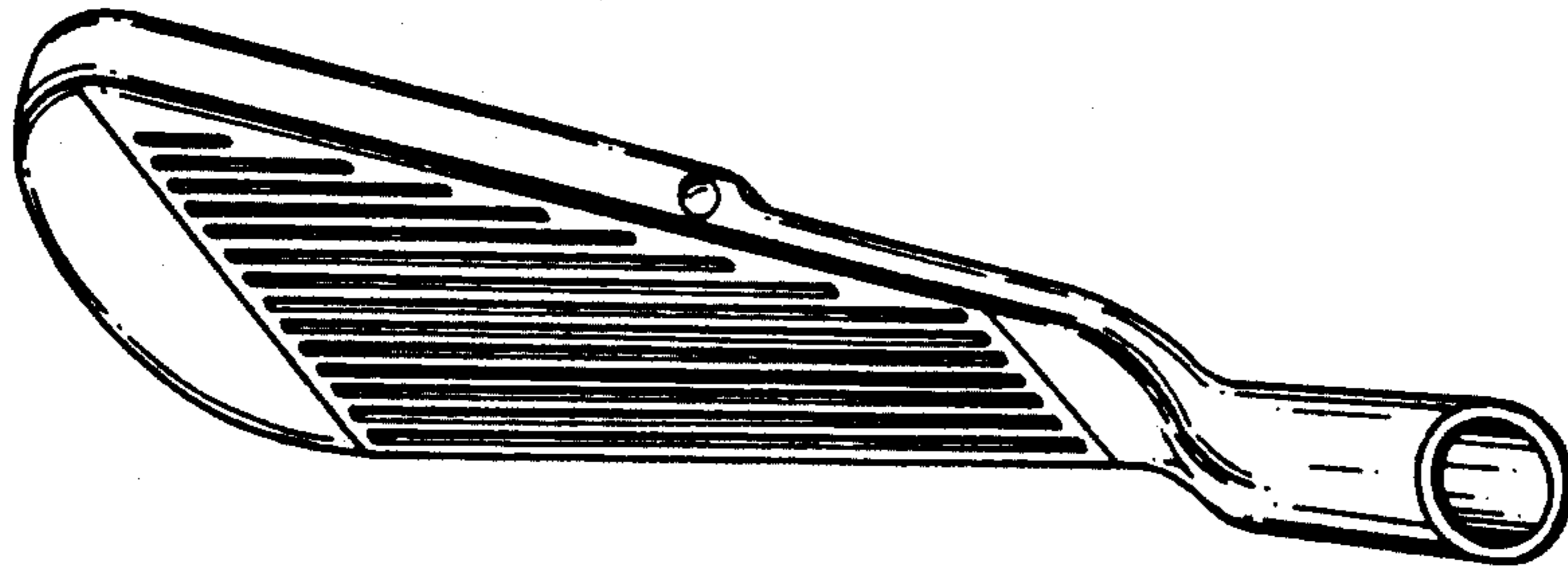

FIG. 9

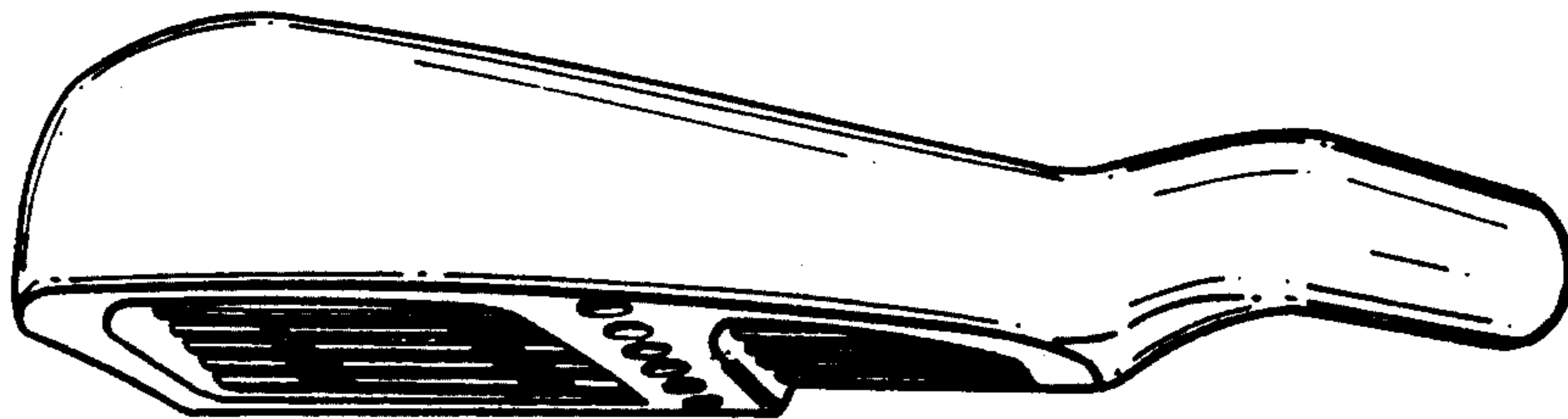

FIG. 10

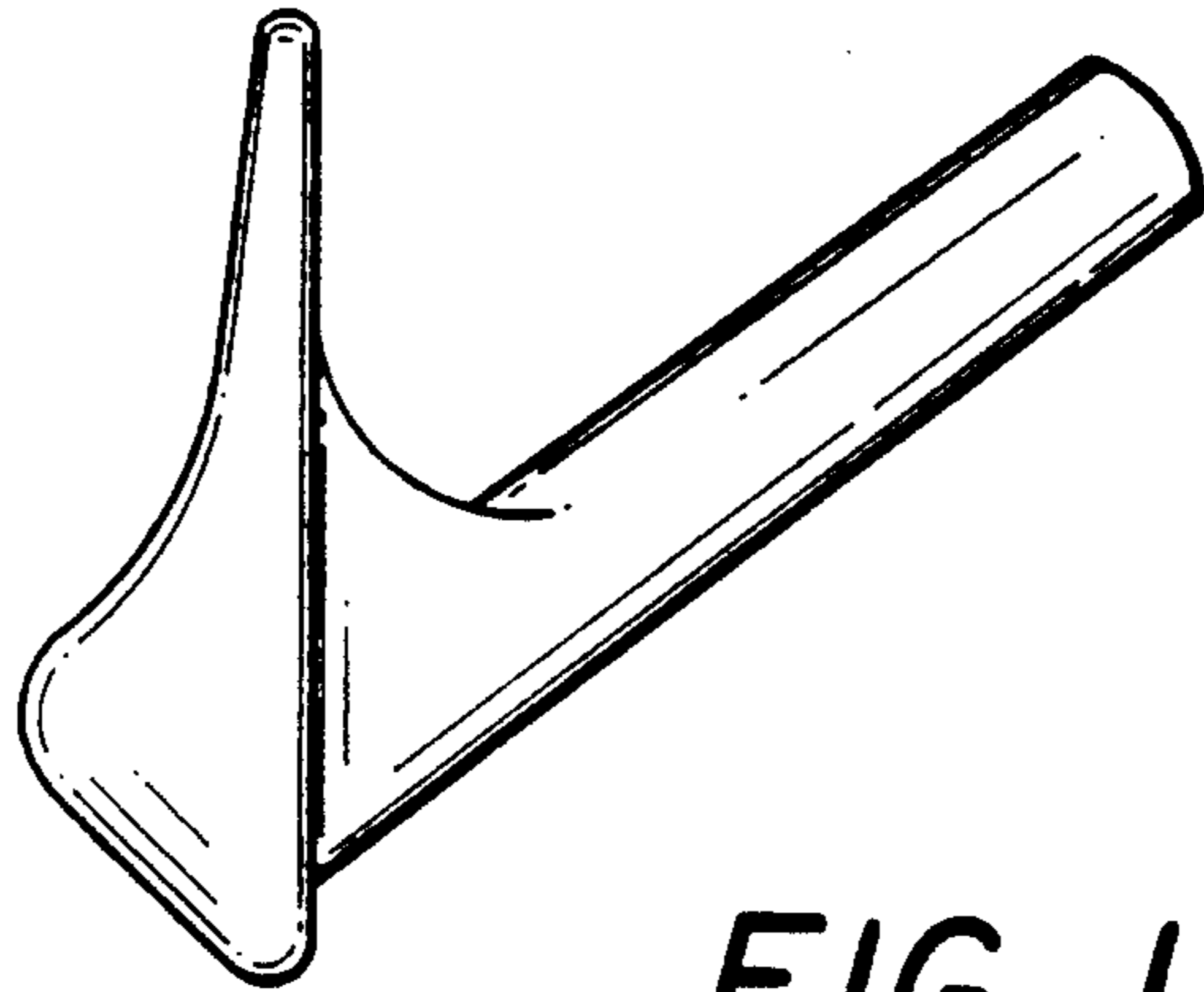

FIG. 11

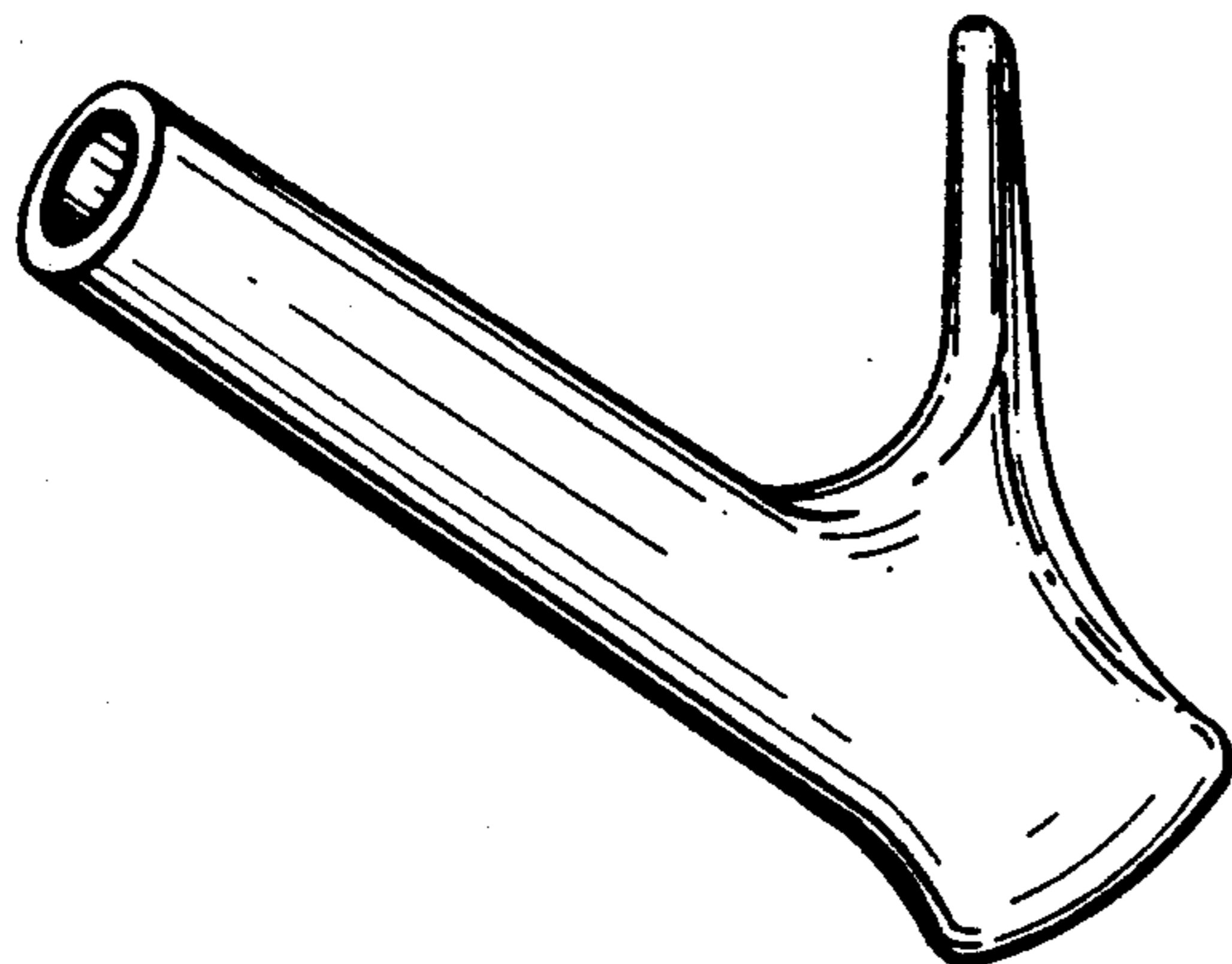

FIG. 12