



US00D336637S

# United States Patent [19]

Abe et al.

[11] Patent Number: **Des. 336,637**

[45] Date of Patent: **\*\* Jun. 22, 1993**

[54] **COMPUTER**

[75] Inventors: **Tetsuji Abe; Kazuhiko Yamagiwa; Benito Mishiro**, all of Osaka, Japan

[73] Assignee: **Matsushita Electric Industrial Co., Ltd.**, Osaka, Japan

[\*\*] Term: **14 Years**

[21] Appl. No.: **653,432**

[22] Filed: **Jan. 30, 1991**

[30] **Foreign Application Priority Data**

Aug. 20, 1990 [JP] Japan ..... 2-27960

[52] U.S. Cl. .... **D14/106**

[58] Field of Search ..... D14/100, 101, 106, 113, D14/115; D18/1, 7, 11, 12; 235/145 A, 145 R; 340/700, 706; 341/22, 23; 361/390, 394; 364/708, 709.04

[56] **References Cited**

**U.S. PATENT DOCUMENTS**

- D. 308,518 6/1990 Wright ..... D14/113 X
- D. 310,210 8/1990 Ishida ..... D14/113 X
- D. 311,907 11/1990 Yoshihara ..... D14/106
- D. 317,912 7/1991 Takai ..... D14/113
- D. 319,222 8/1991 Mizusugi et al. .... D14/106
- D. 326,846 6/1992 Lerude ..... D14/106

**OTHER PUBLICATIONS**

PC Magazine Mar. 13, 1990. p. 149—Computer/IBM.

Sharp catalog "Personal Work Station (PC-8041)", published Oct. 1989.

IBM catalog "IBM Personal System/55 (Model 5545)", publication date unknown, computer believed to have been sold commercially in the U.S. since Jun. of 1988.

*Primary Examiner*—Wallace R. Burke

*Assistant Examiner*—Freda S. Nunn

*Attorney, Agent, or Firm*—Sughrue, Mion, Zinn, Macpeak & Seas

[57] **CLAIM**

The ornamental design for a computer, as shown and described.

**DESCRIPTION**

FIG. 1 is a front, top and right side perspective view of a computer showing our new design;

FIG. 2 is a front elevational view thereof;

FIG. 3 is a rear elevational view thereof;

FIG. 4 is a top plan view thereof;

FIG. 5 is a bottom plan view thereof;

FIG. 6 is a left side elevational view thereof;

FIG. 7 is a right side elevational view thereof;

FIG. 8 is a front top and right side perspective view thereof with the display panel being pivoted outwardly from the housing in a downwardly and forwardly position; and,

FIG. 9 is a rear top and left side perspective view thereof with a separate keyboard positioned in front of the computer display panel being shown in broken lines for illustrative purposes only and forms no part of the claimed design.

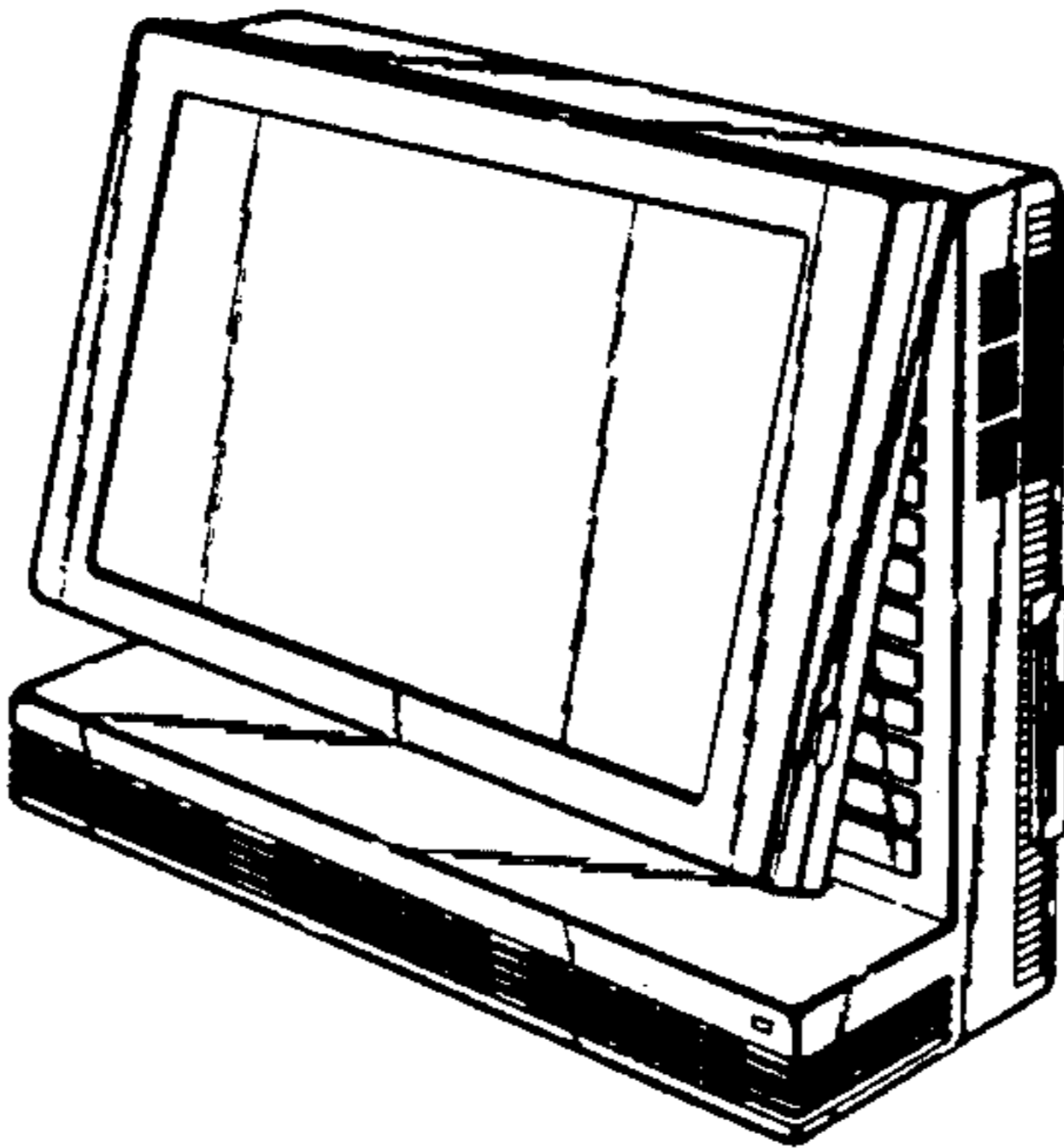
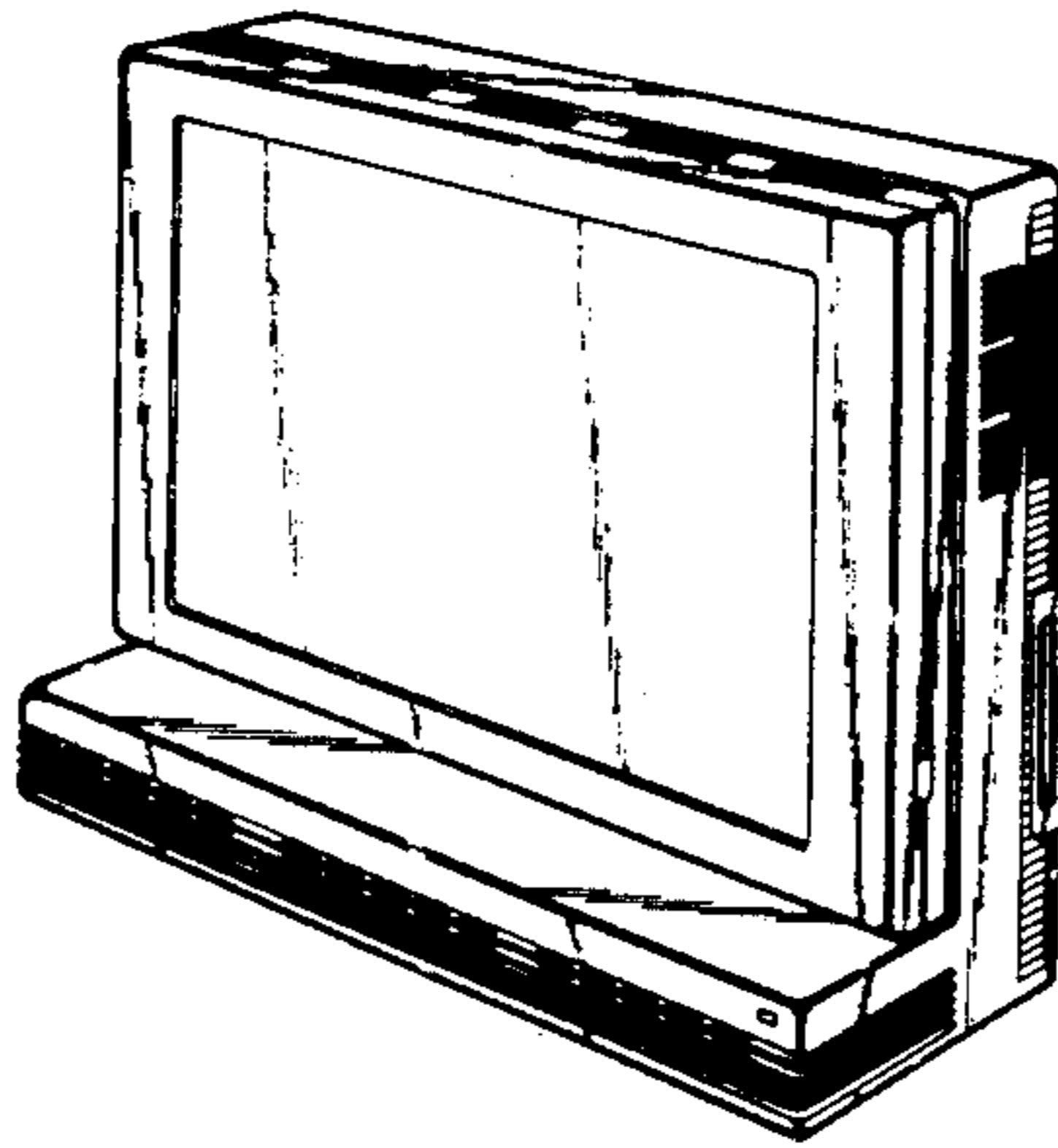

*Fig. 1*

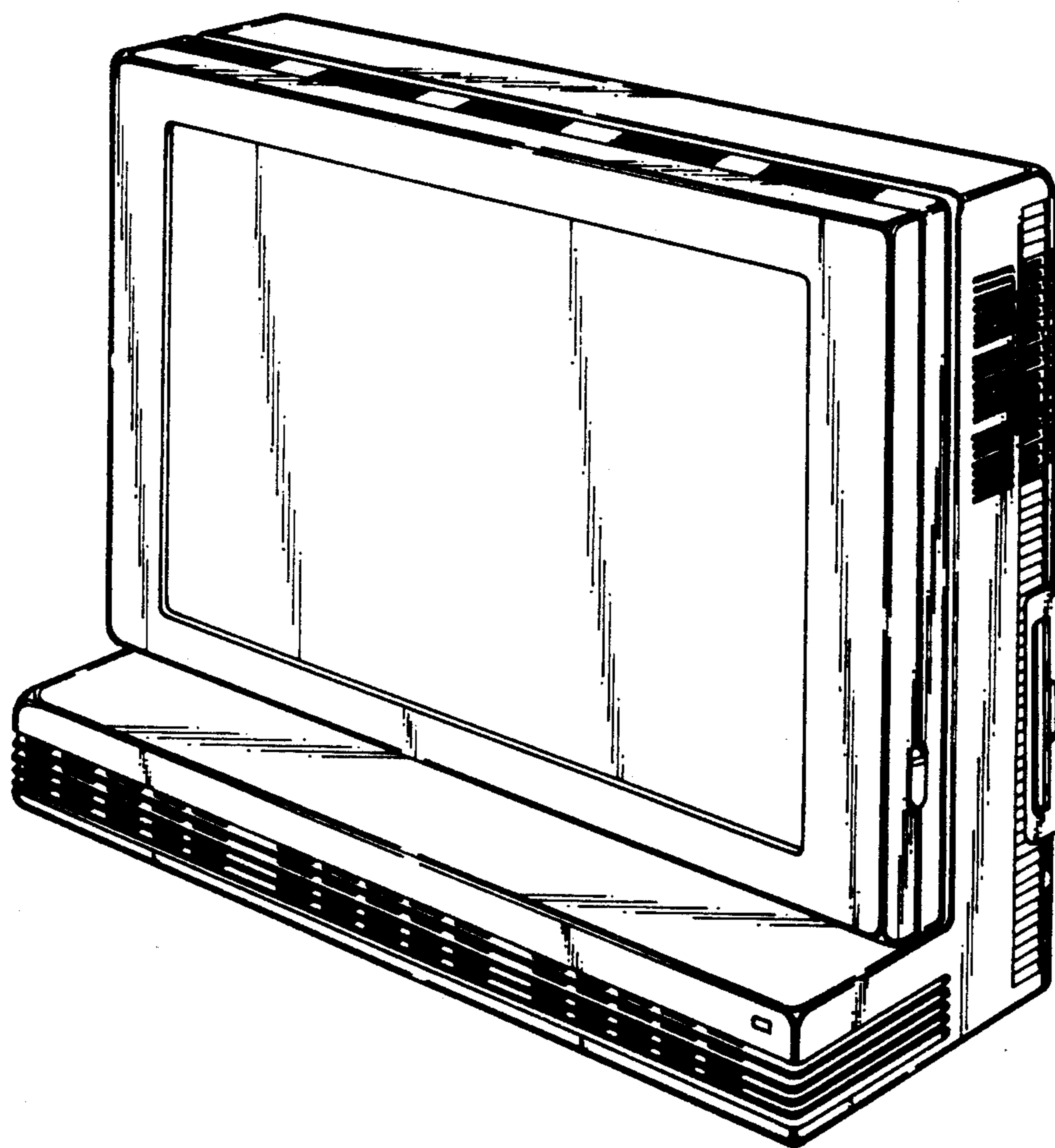

*Fig. 2*

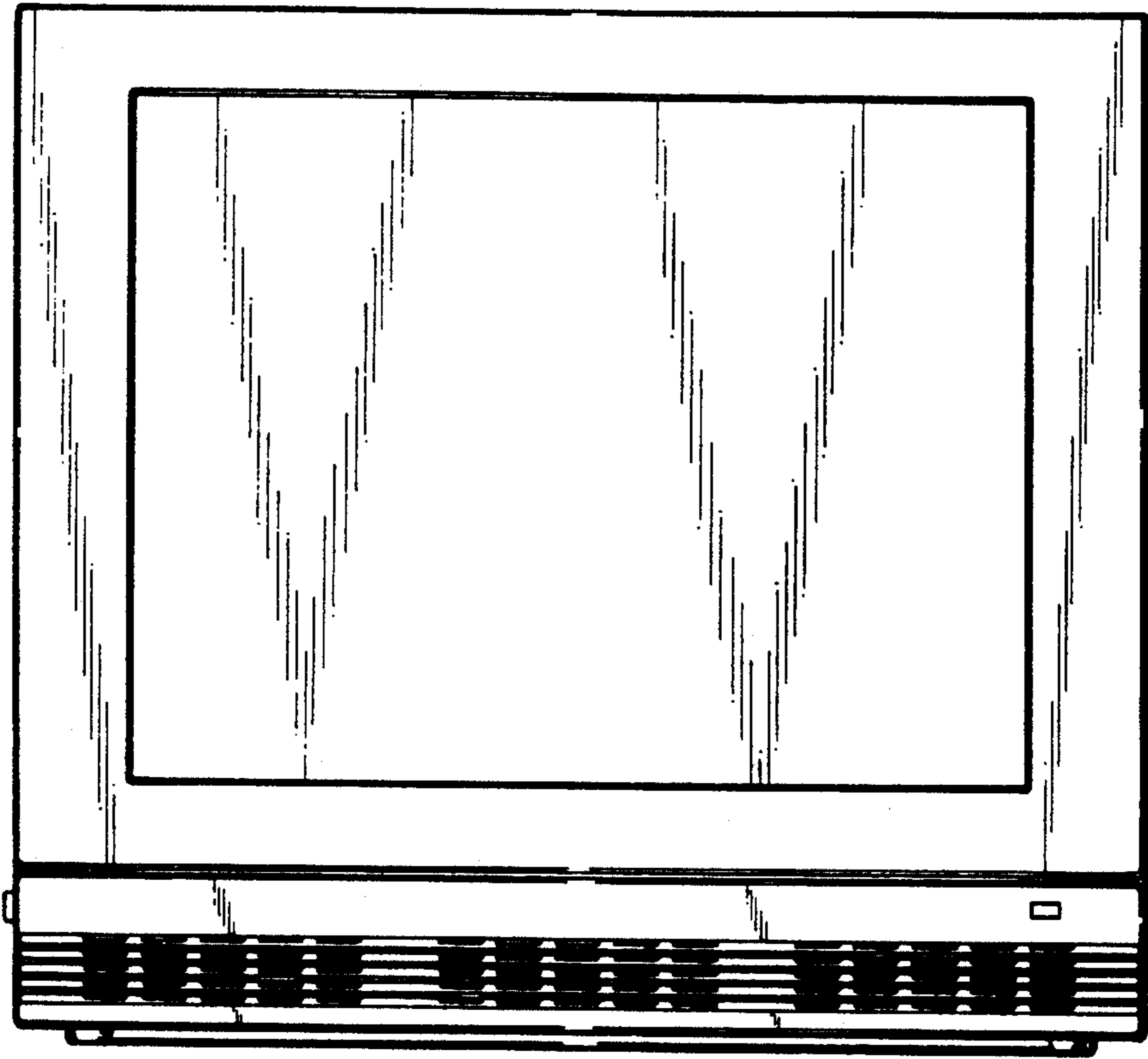

*Fig. 3*

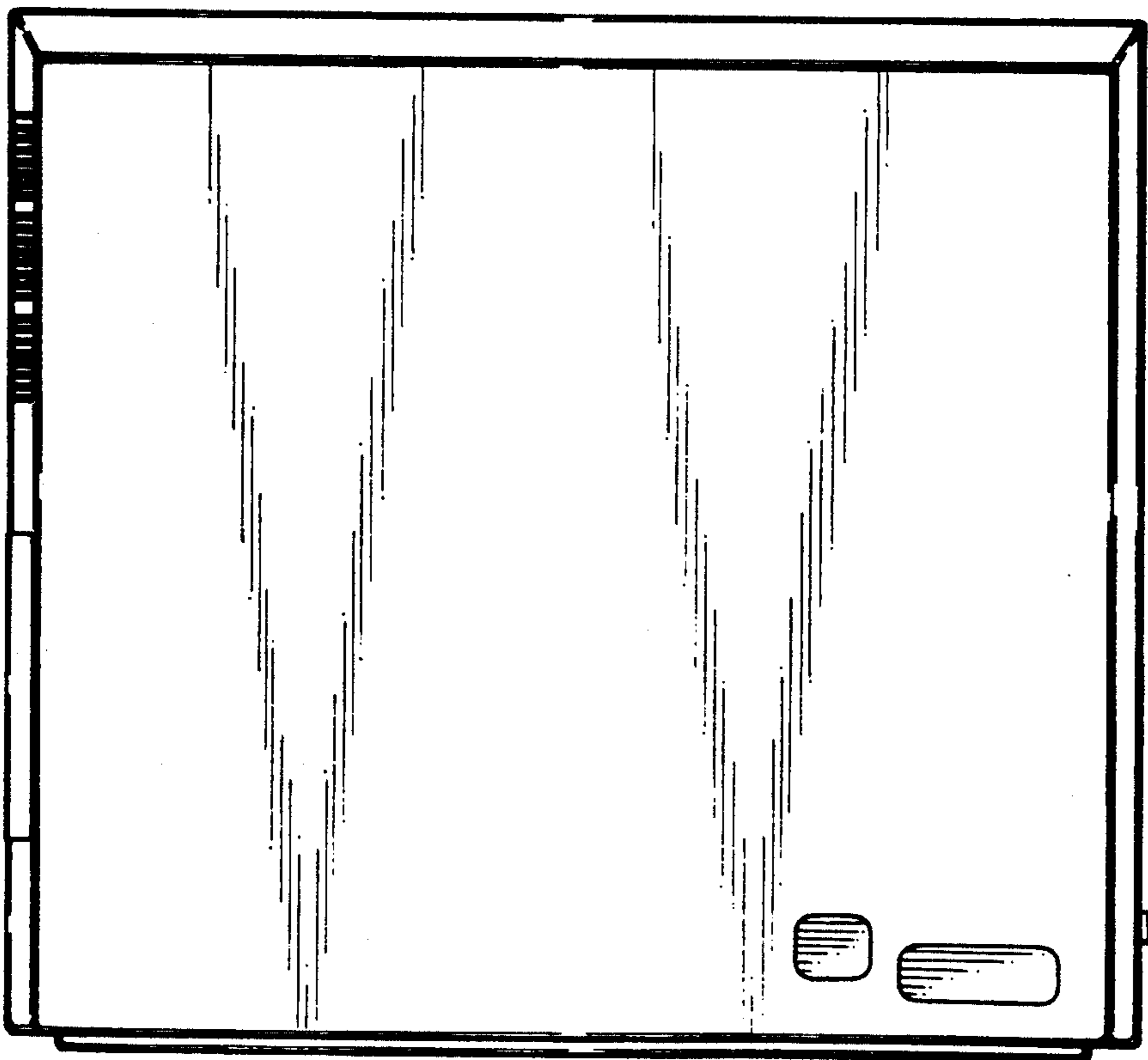

*Fig. 4*

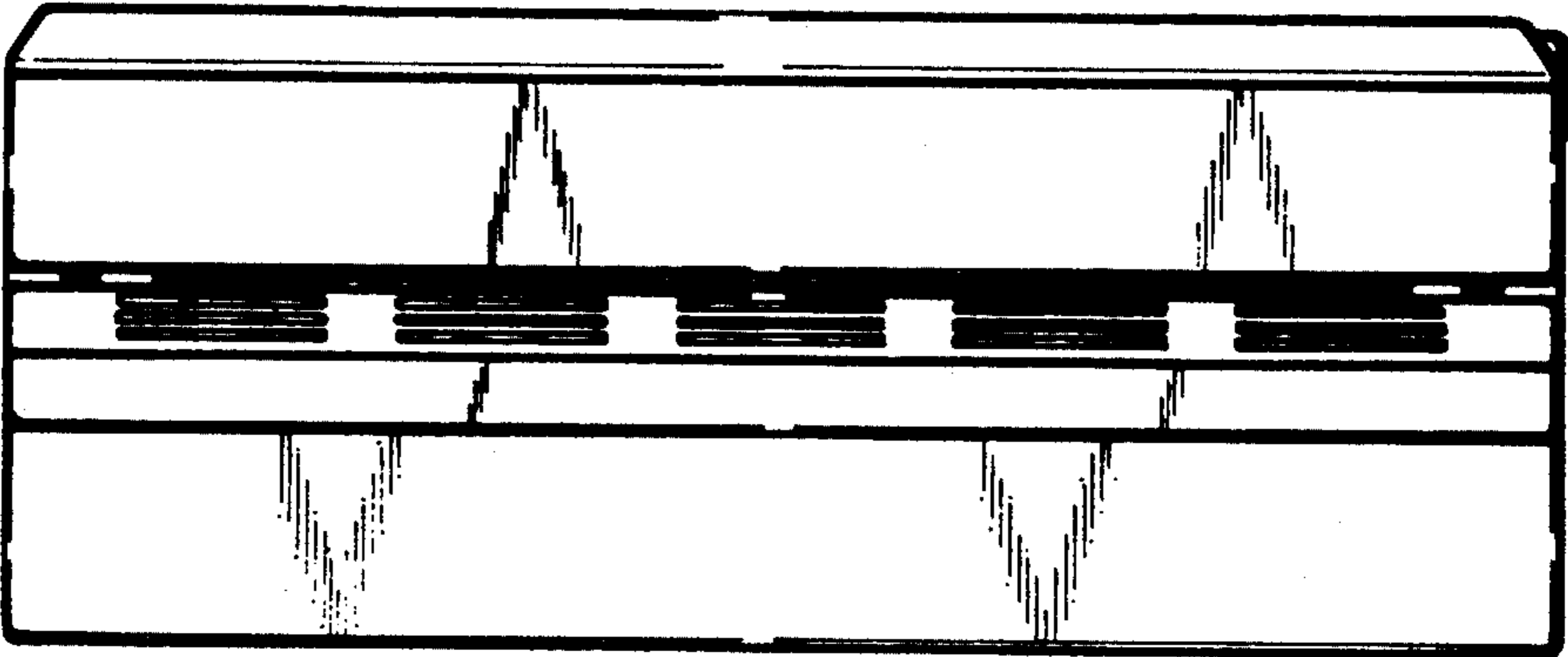

*Fig. 5*

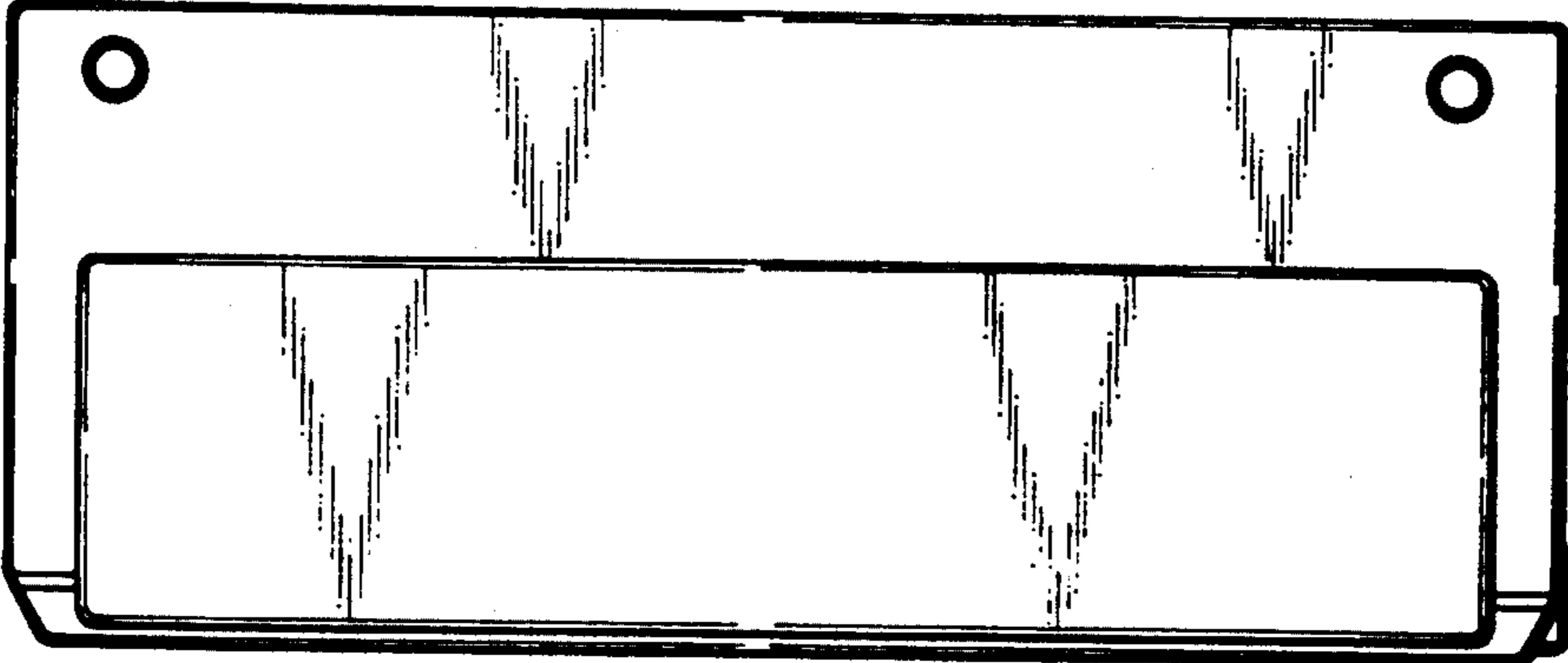

*Fig. 6*

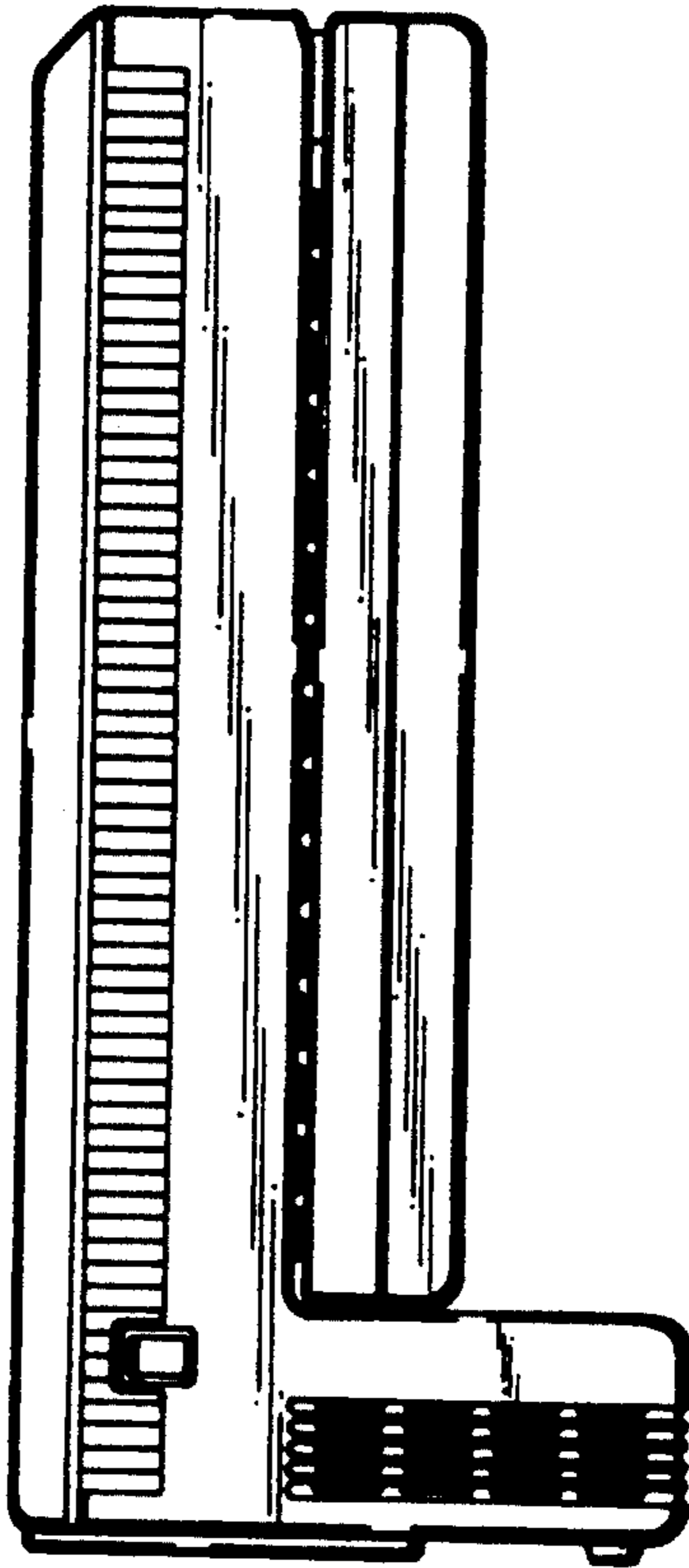

*Fig. 7*

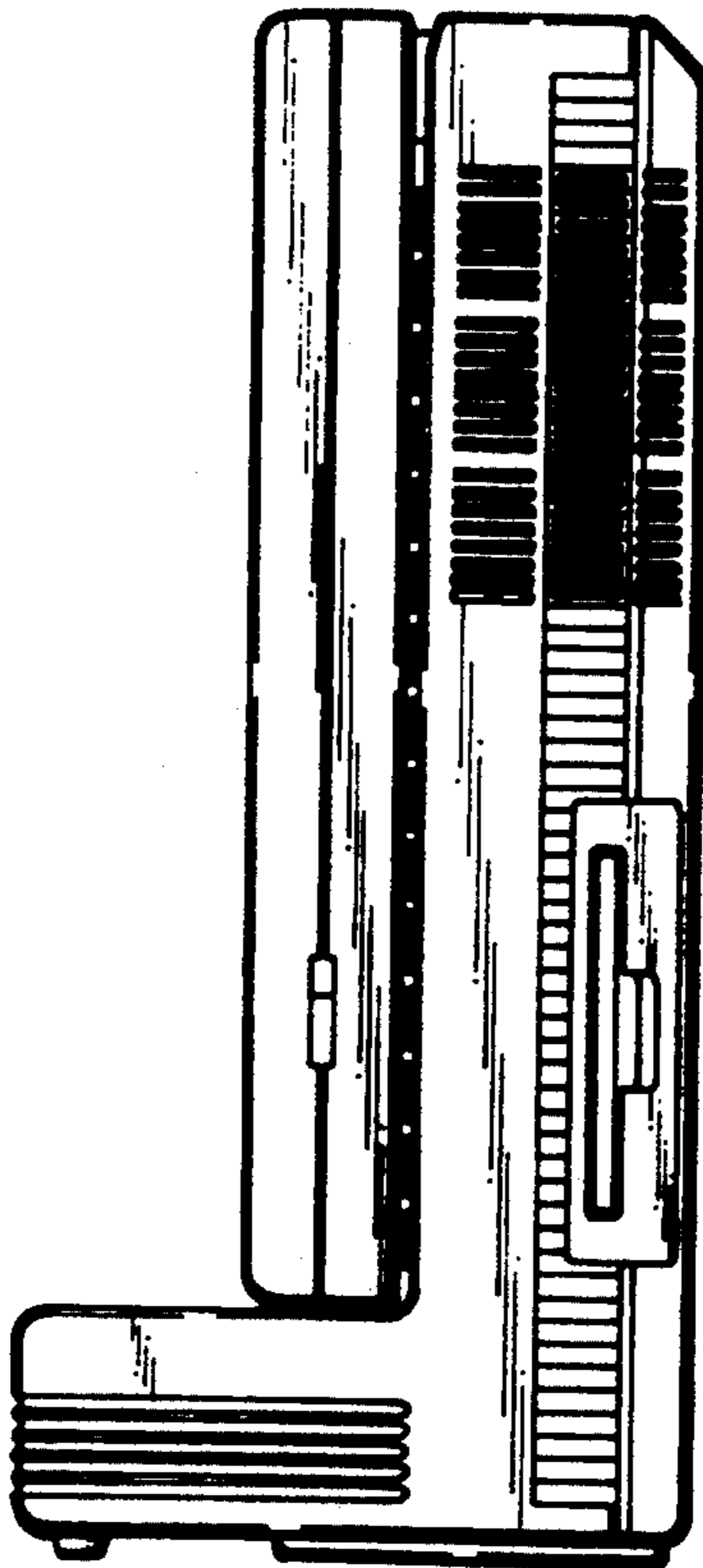

*Fig. 8*

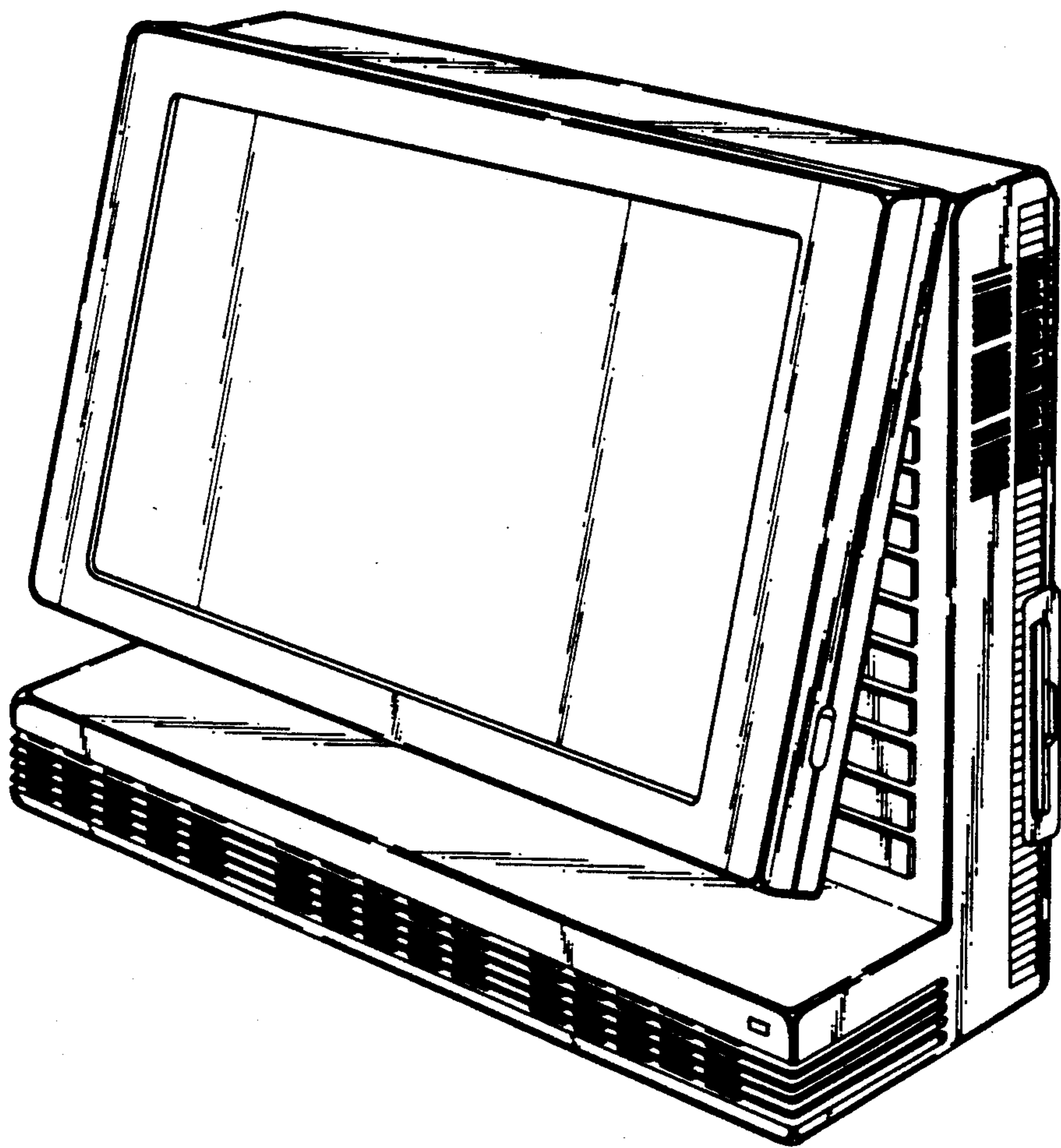

*Fig. 9*

