



US00D336630S

United States Patent [19]

[11] Patent Number: **Des. 336,630**

Villalon et al.

[45] Date of Patent: **** Jun. 22, 1993**

[54] RECREATIONAL BOAT

[75] Inventors: **Augusto Villalon; Wolfgang Schneider**, both of Cape Coral, Fla.

[73] Assignee: **Outboard Marine Corporation**, Waukegan, Ill.

[**] Term: **14 Years**

[21] Appl. No.: **702,193**

[22] Filed: **May 15, 1991**

[52] U.S. Cl. **D12/313; D12/300**

[58] Field of Search **D12/300, 310-315, D12/318; 114/56, 343, 355, 356, 357, 358**

[56] **References Cited**
PUBLICATIONS

Boating, (Jan. 1982), p. 85, "Stamas 26 Tarpon".

Boating (Oct. 1980), p. 57, "Robalo".
Four Winns Fishing Fleet Catalog, Published in 1988.

Primary Examiner—Kay H. Chin

[57] **CLAIM**

The ornamental design for a recreational boat, as shown and described.

DESCRIPTION

FIG. 1 is a rear elevational view of a recreational boat showing our new design;

FIG. 2 is a side elevational view thereof, the opposite side elevational view being a mirror image of that shown;

FIG. 3 is a front elevational view thereof;

FIG. 4 is a top plan view thereof;

FIG. 5 is a bottom plan view thereof;

FIG. 6 is a top and front perspective view thereof; and,

FIG. 7 is a top and rear perspective view thereof.

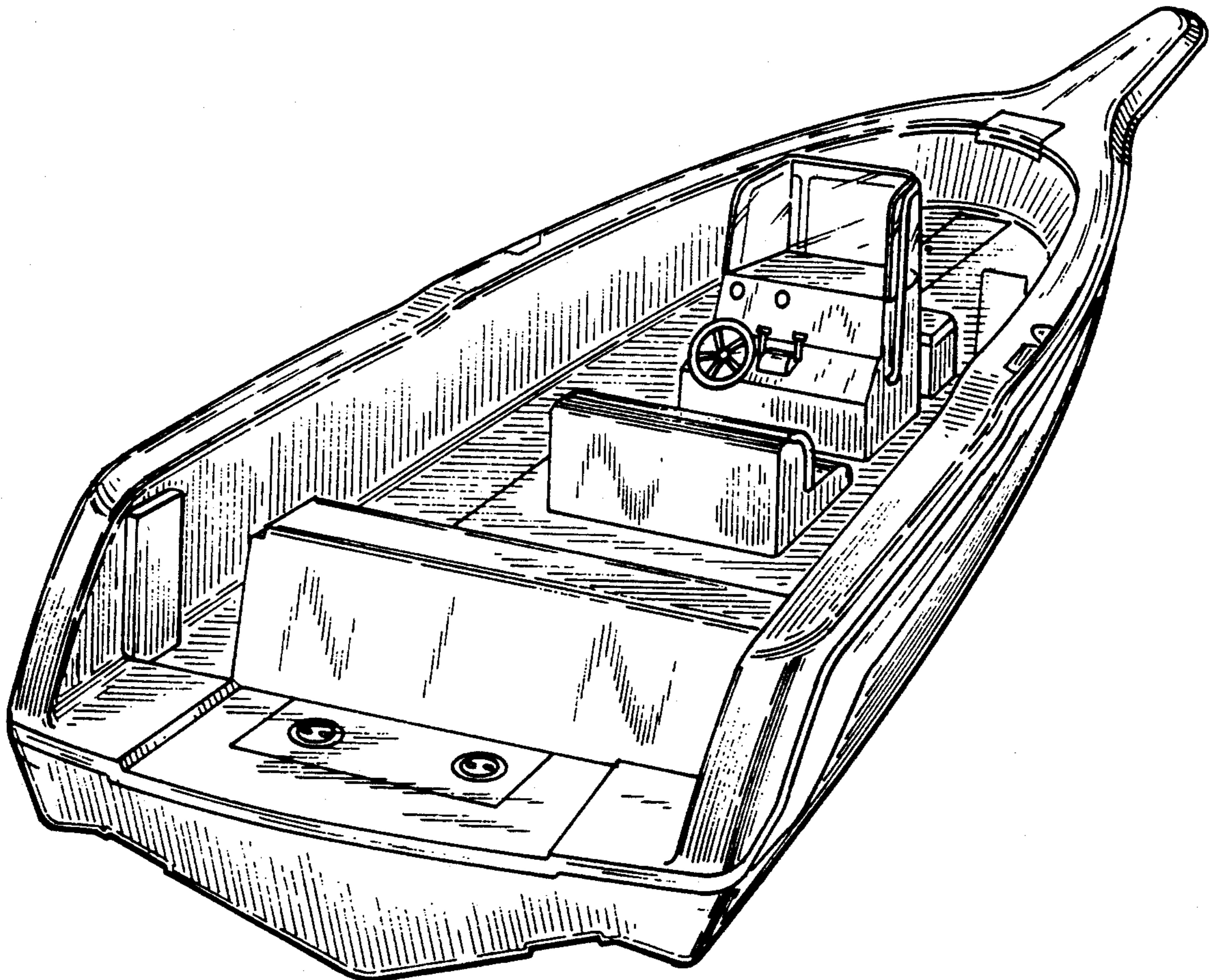

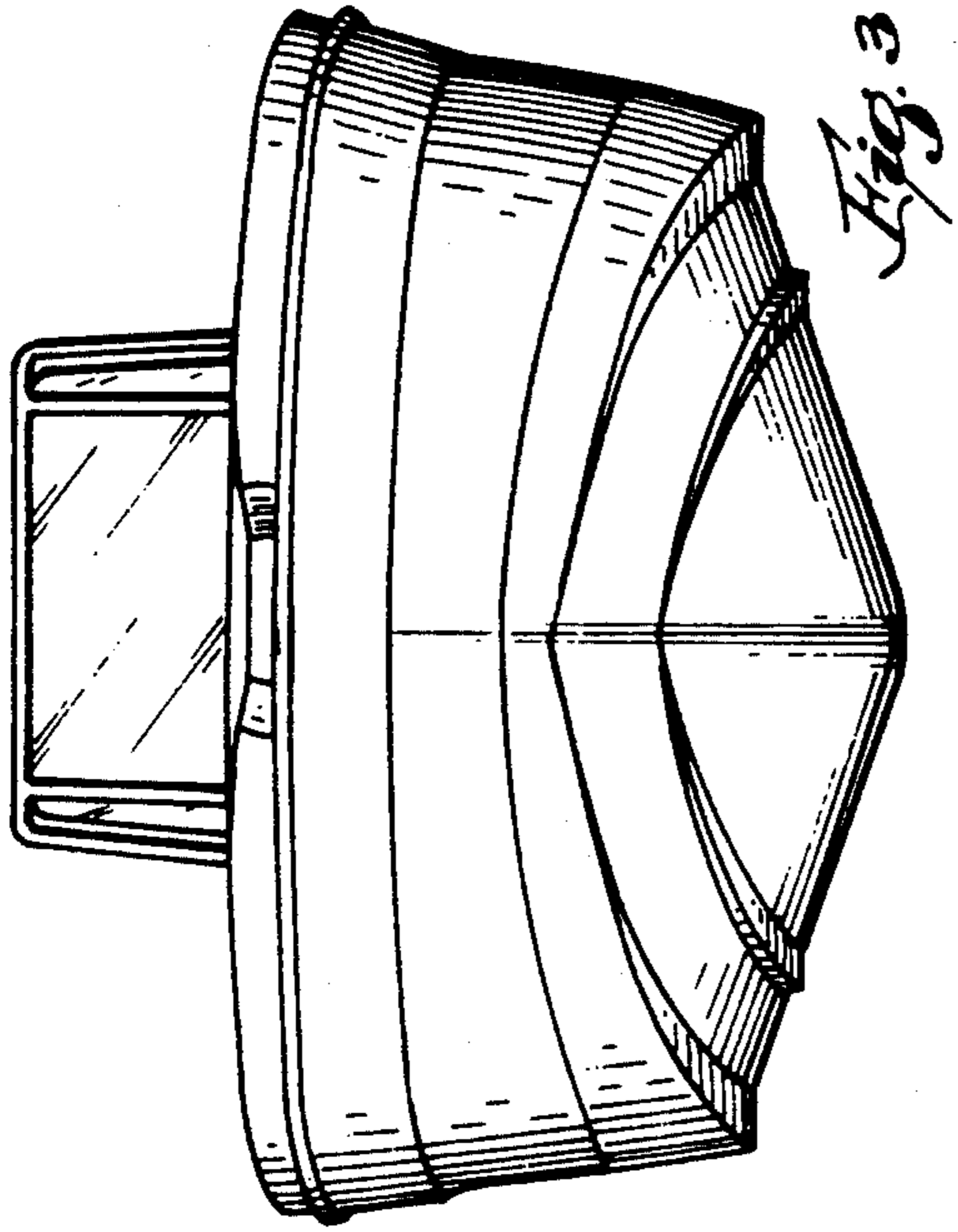

Fig. 3

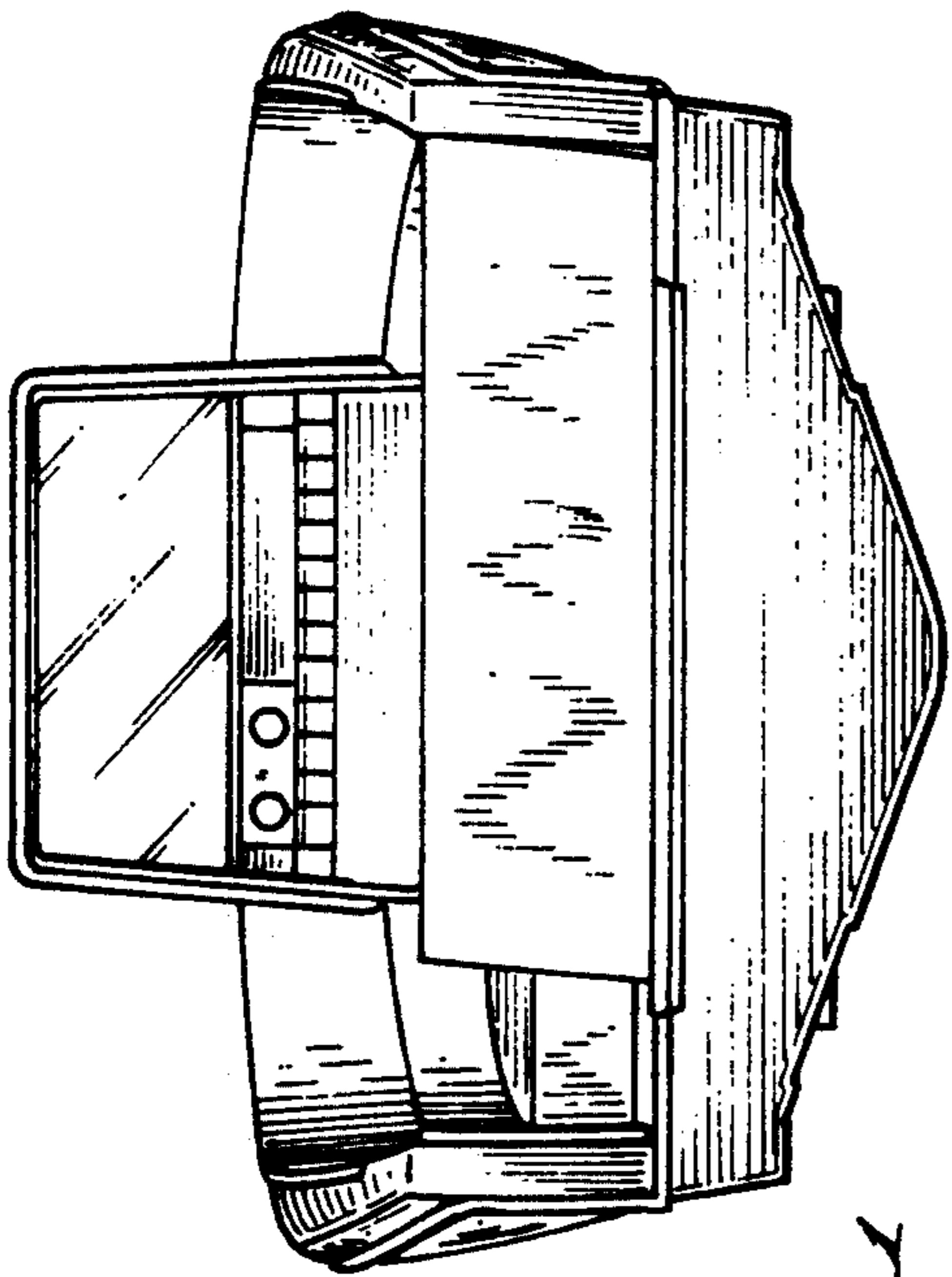

Fig. 1

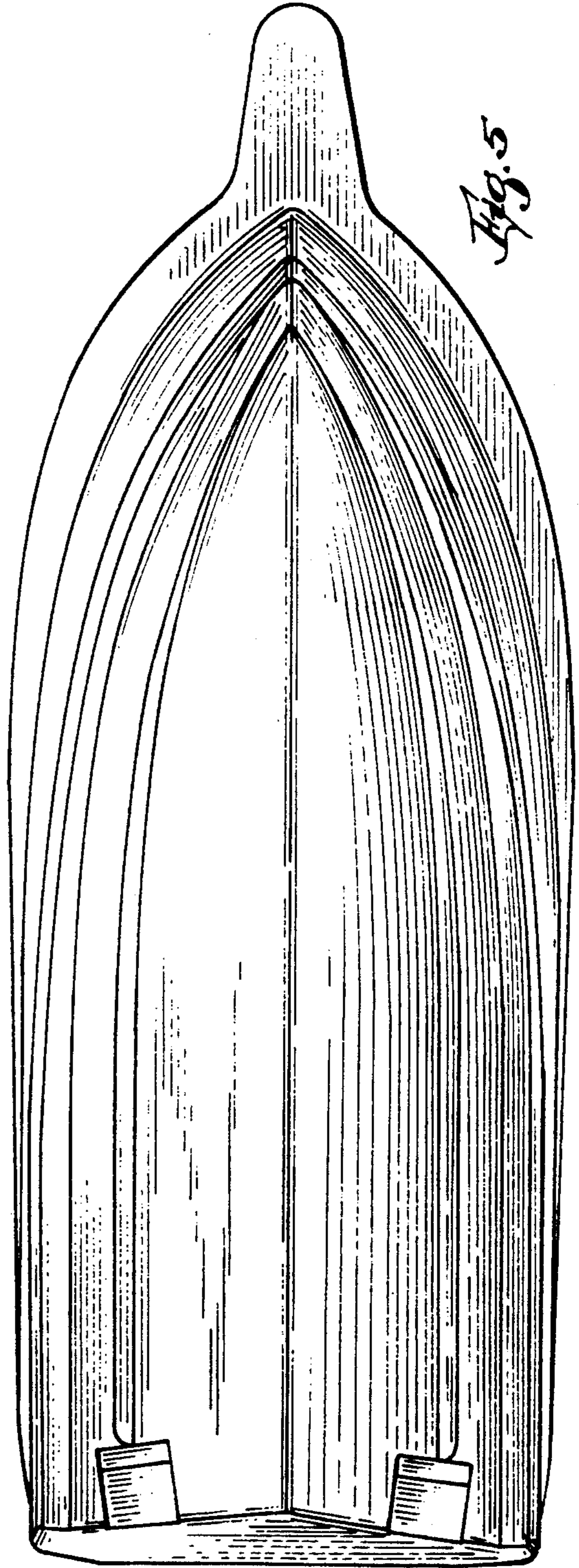
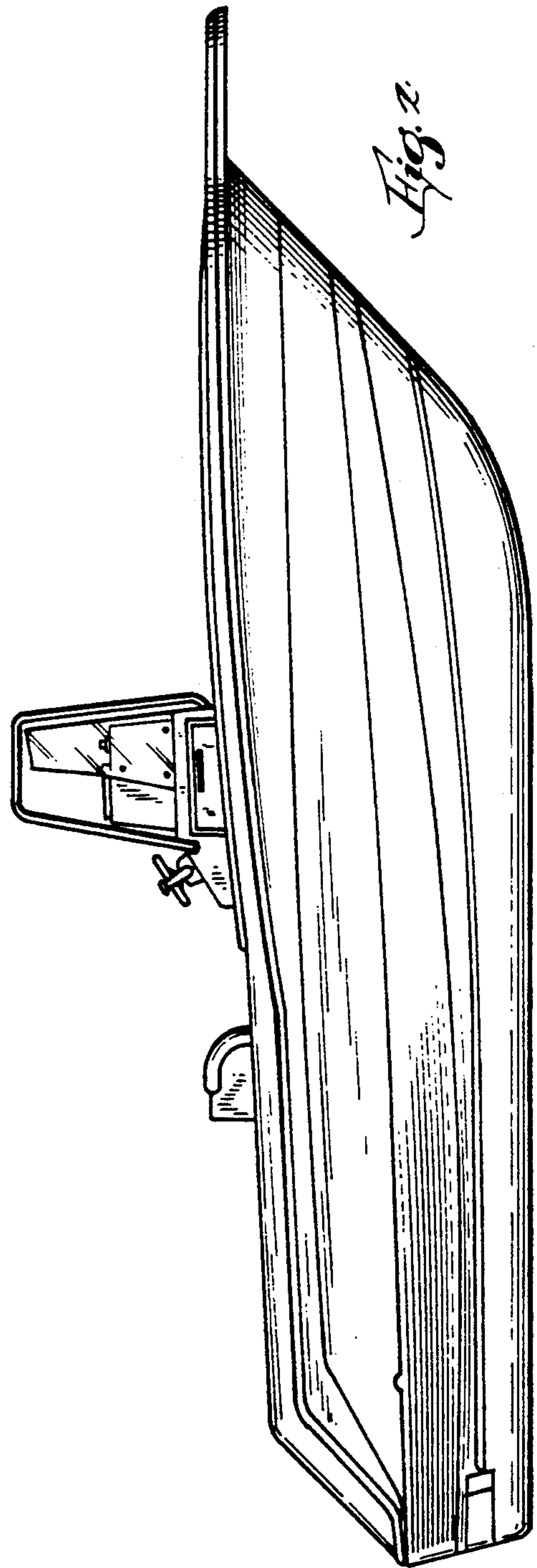
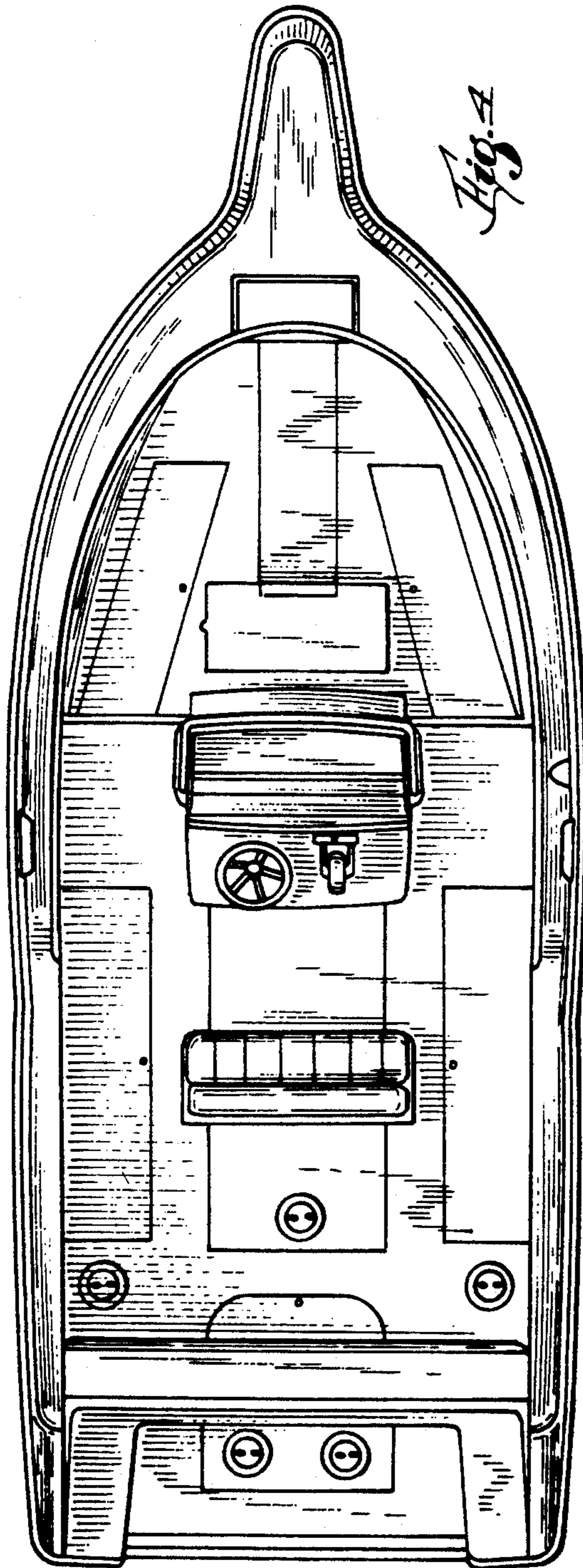

Fig. 5



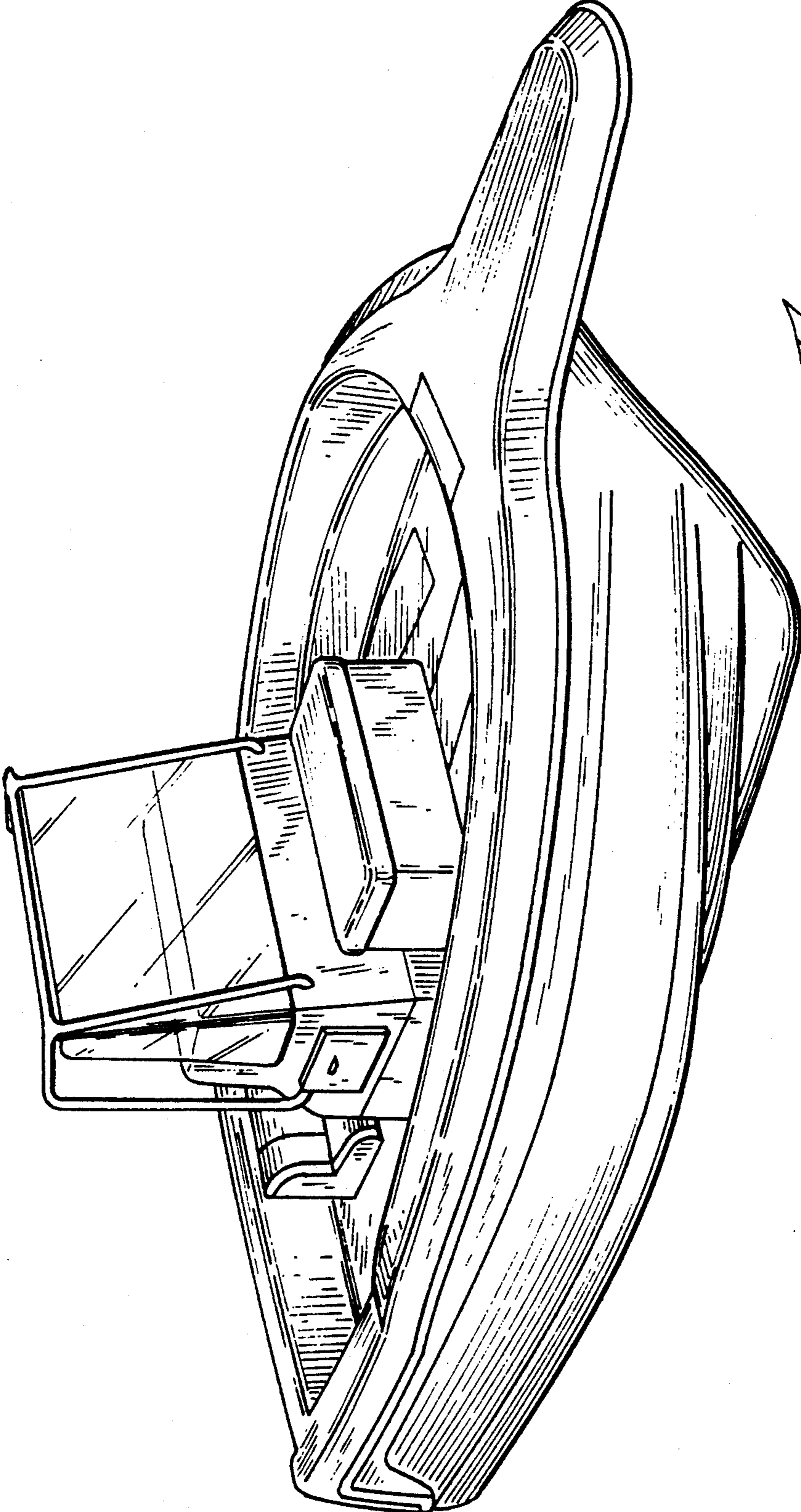

Fig. 6

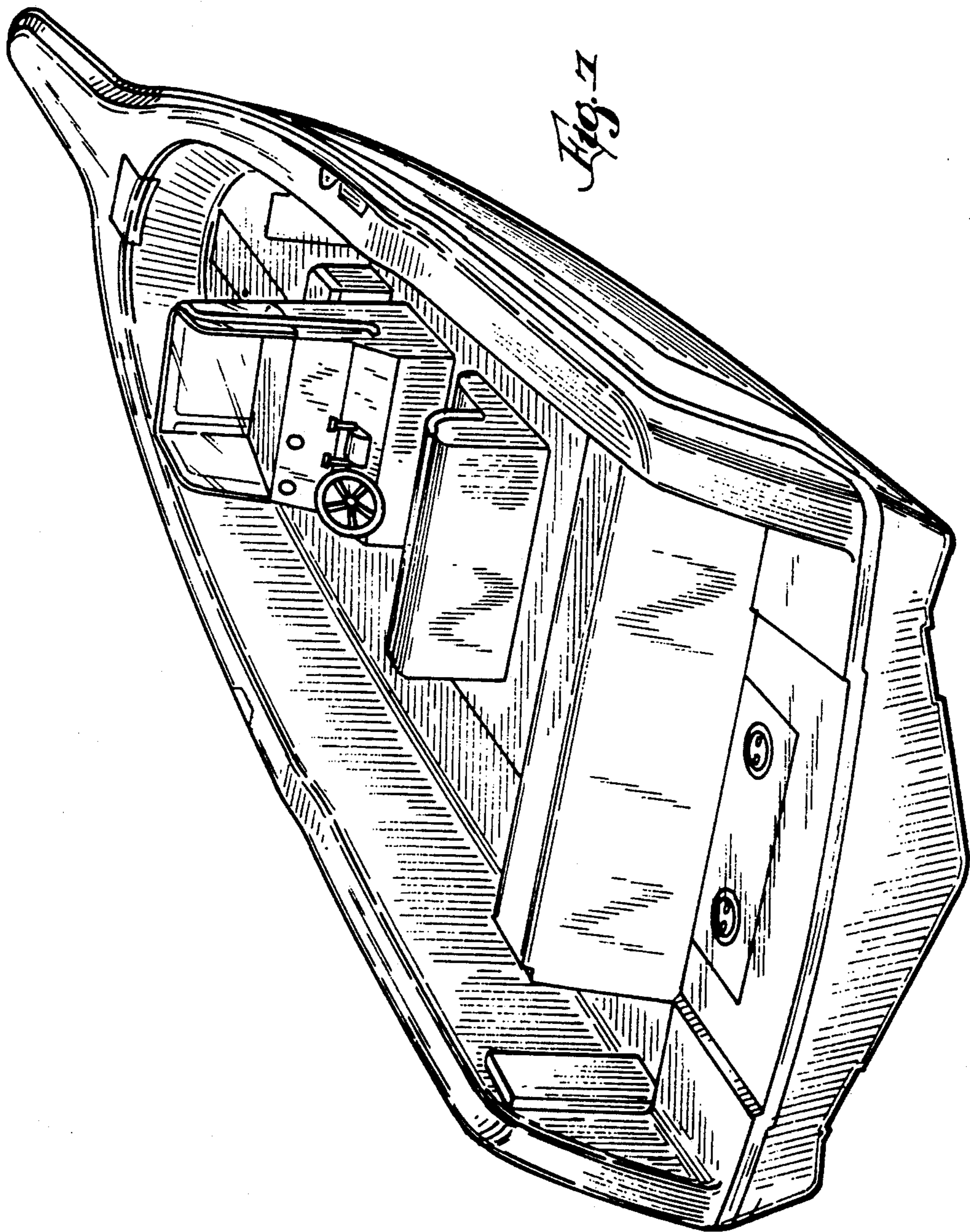

Fig. 7