



US00D336607S

United States Patent [19]
Nye

[11] **Patent Number: Des. 336,607**
[45] **Date of Patent: ** Jun. 22, 1993**

[54] **DISPENSING CONTAINER**

[76] **Inventor: Norman H. Nye, 1348 Highbridge Rd., Cuyahoga Falls, Ohio 44223**

[**] **Term: 14 Years**

[21] **Appl. No.: 933,051**

[22] **Filed: Aug. 19, 1992**

[52] **U.S. Cl. D9/300; D9/523**

[58] **Field of Search D9/300, 516, 526, 523, D9/549, 435; 222/105, 182, 212, 566, 372, 373, 405, 635**

4,228,930 10/1980 Hogan 222/212
4,437,587 3/1984 Duering 222/207

Primary Examiner—Bernard Ansher
Assistant Examiner—Mitchell I. Siegel
Attorney, Agent, or Firm—Oldham, Oldham & Wilson

[57] **CLAIM**

The ornamental design for a dispensing container, as shown and described.

DESCRIPTION

FIG. 1 is a front elevational view of a dispensing container;
FIG. 2 is a right side elevational view thereof; the underclosed opposite side being a mirror image;
FIG. 3 is a bottom plan view thereof;
FIG. 4 is a top plan view thereof; and,
FIG. 5 is a rear elevational view thereof.
The bottom surface of the container is unadorned.

[56] **References Cited**

U.S. PATENT DOCUMENTS

D. 143,264 12/1945 Boe D9/300
D. 165,034 10/1951 Van Sciver D9/300 X
D. 267,858 2/1983 Spates D9/526

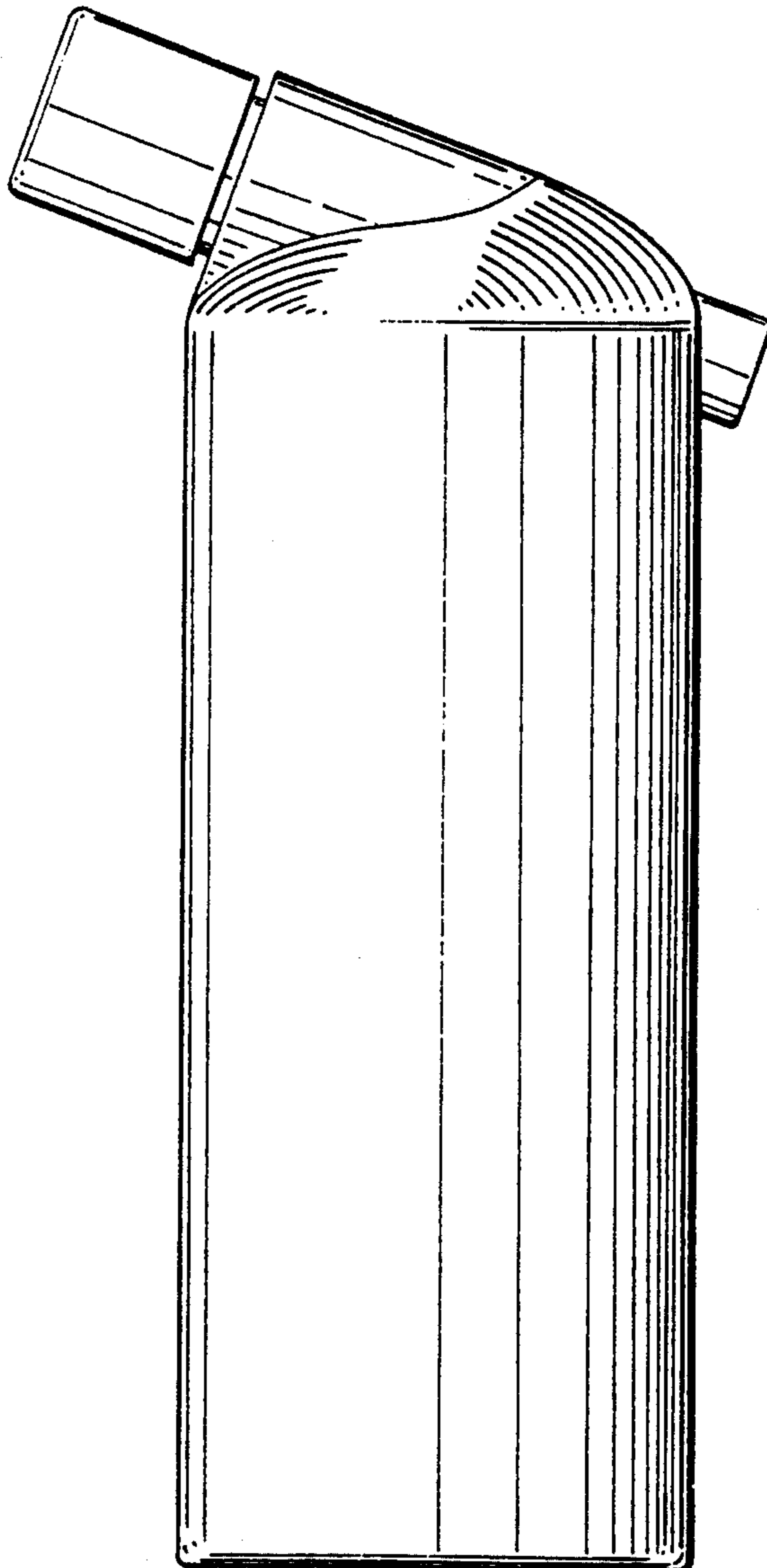
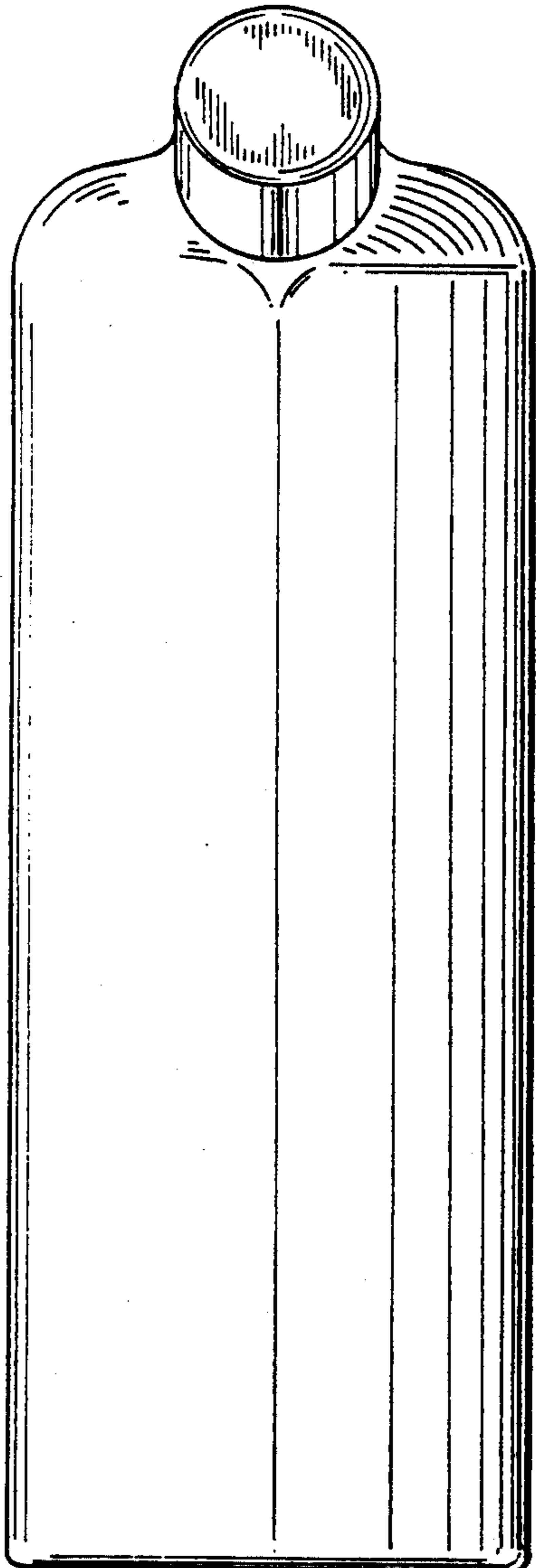

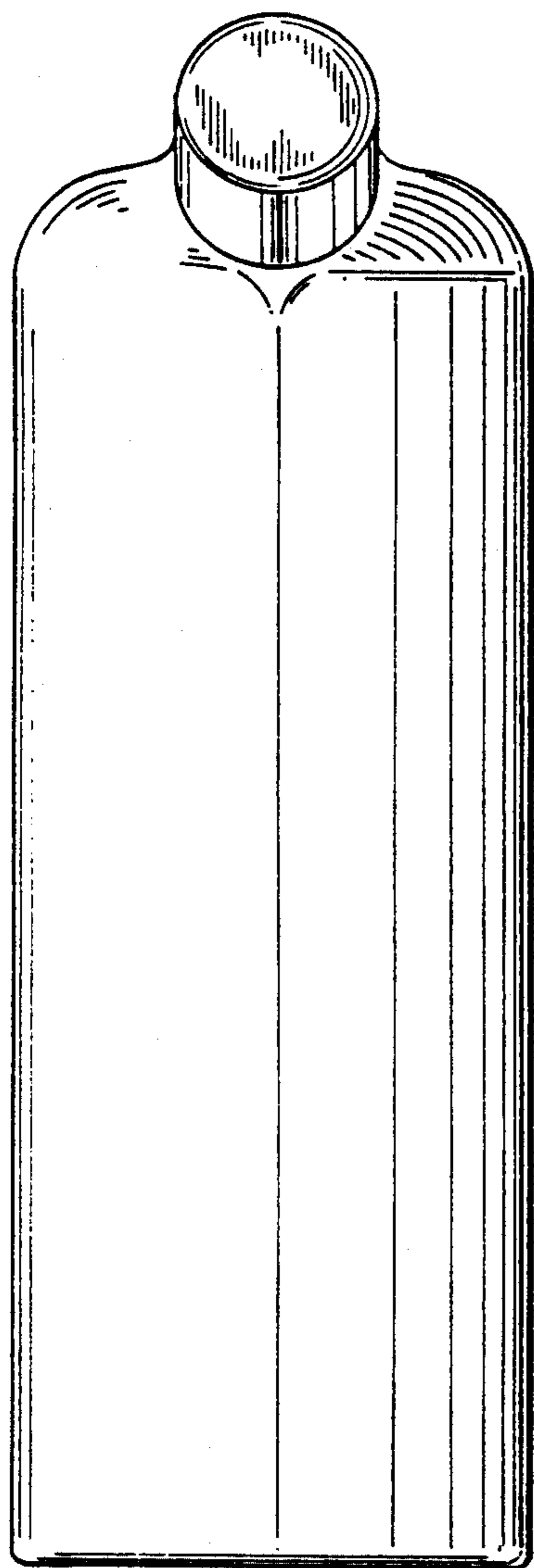

FIG.-1

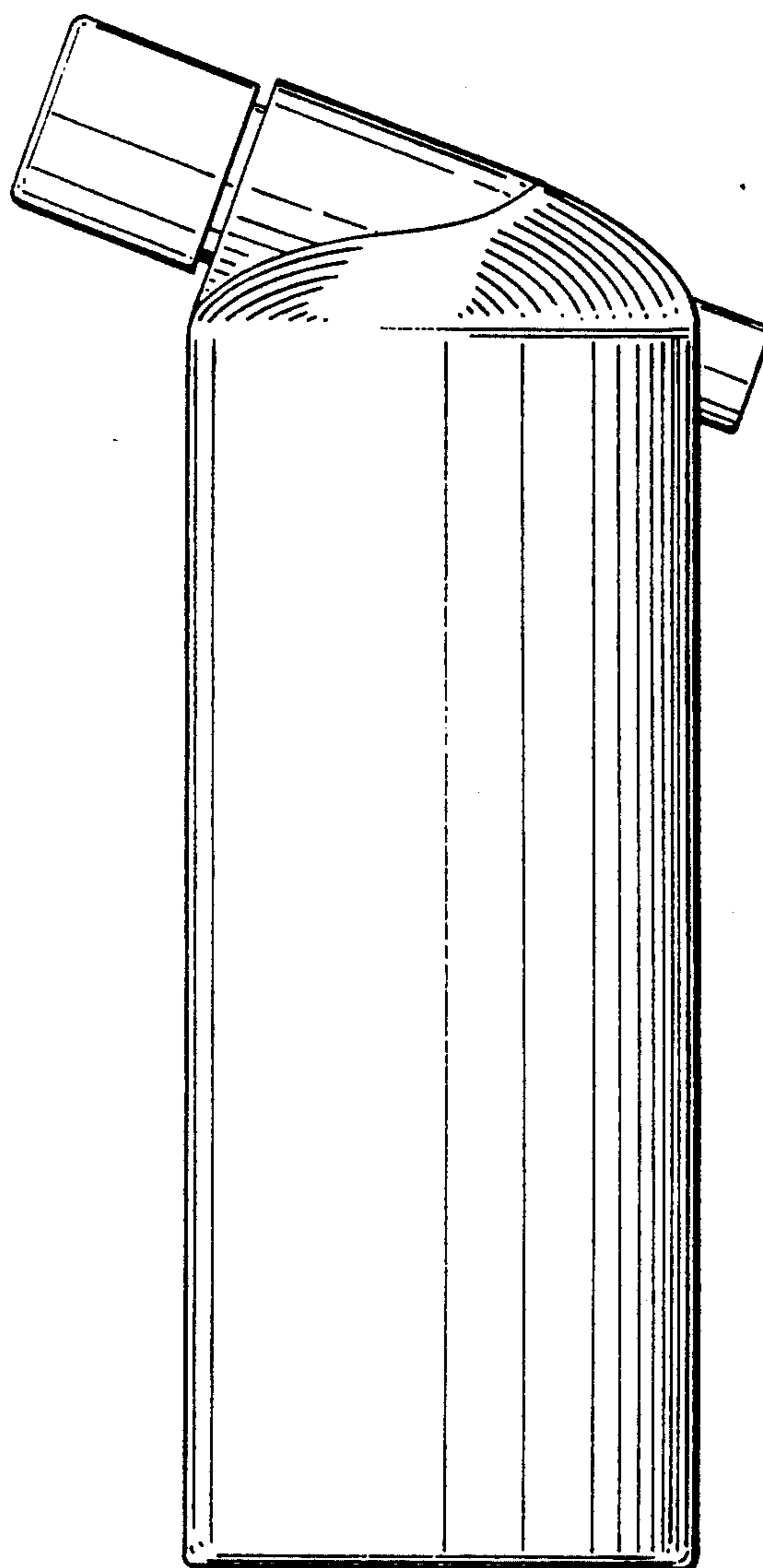

FIG.-2

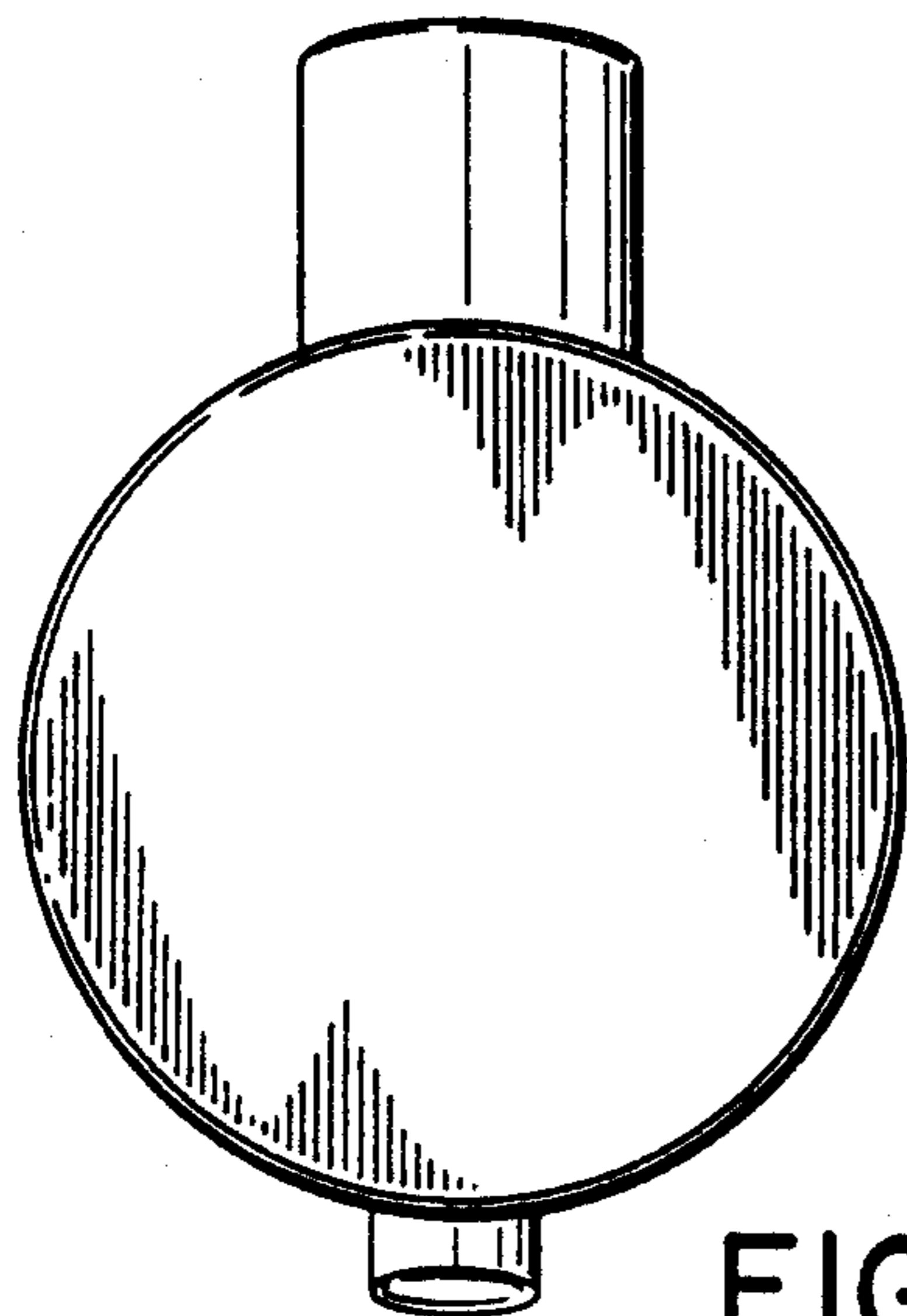

FIG.-3

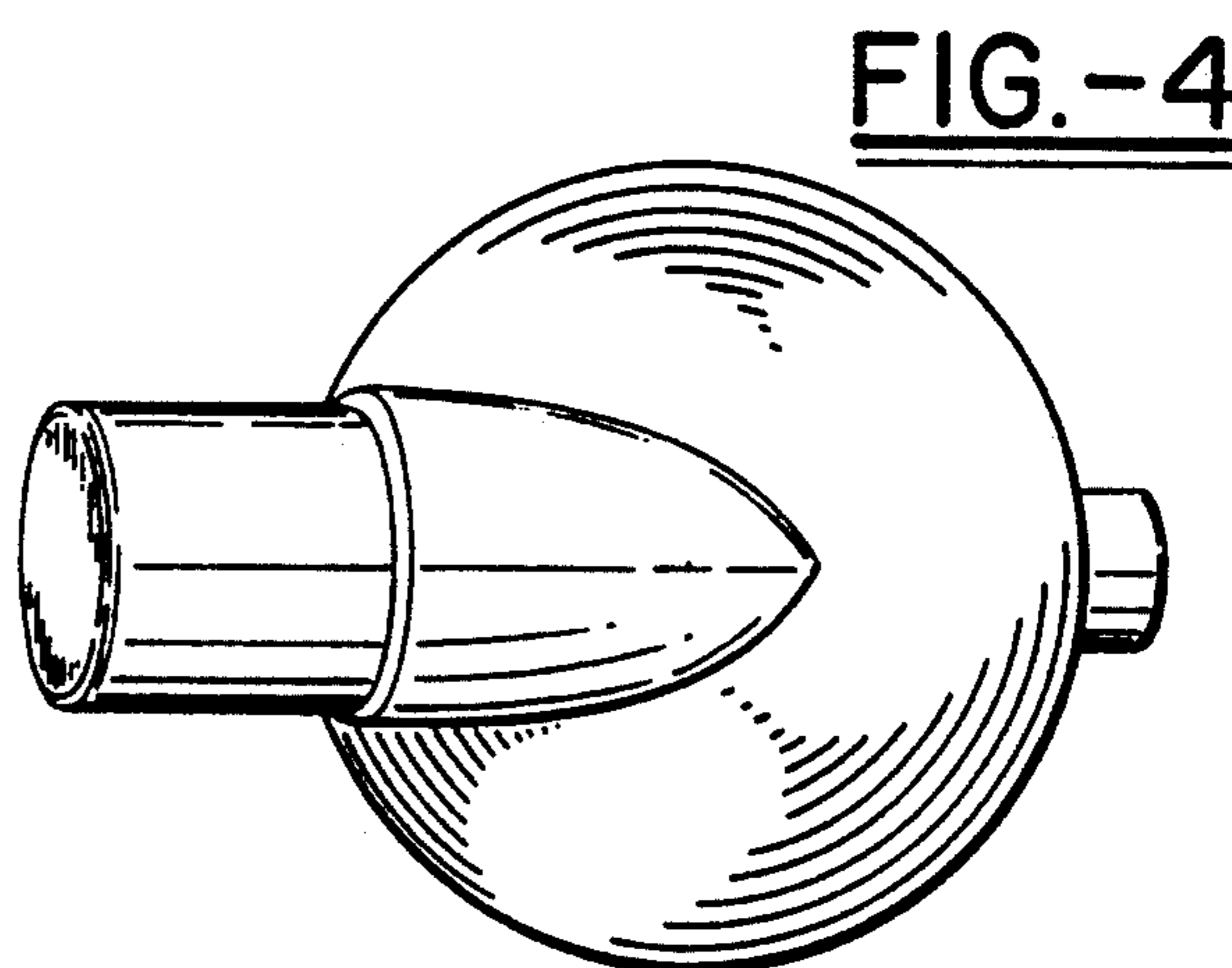

FIG.-4

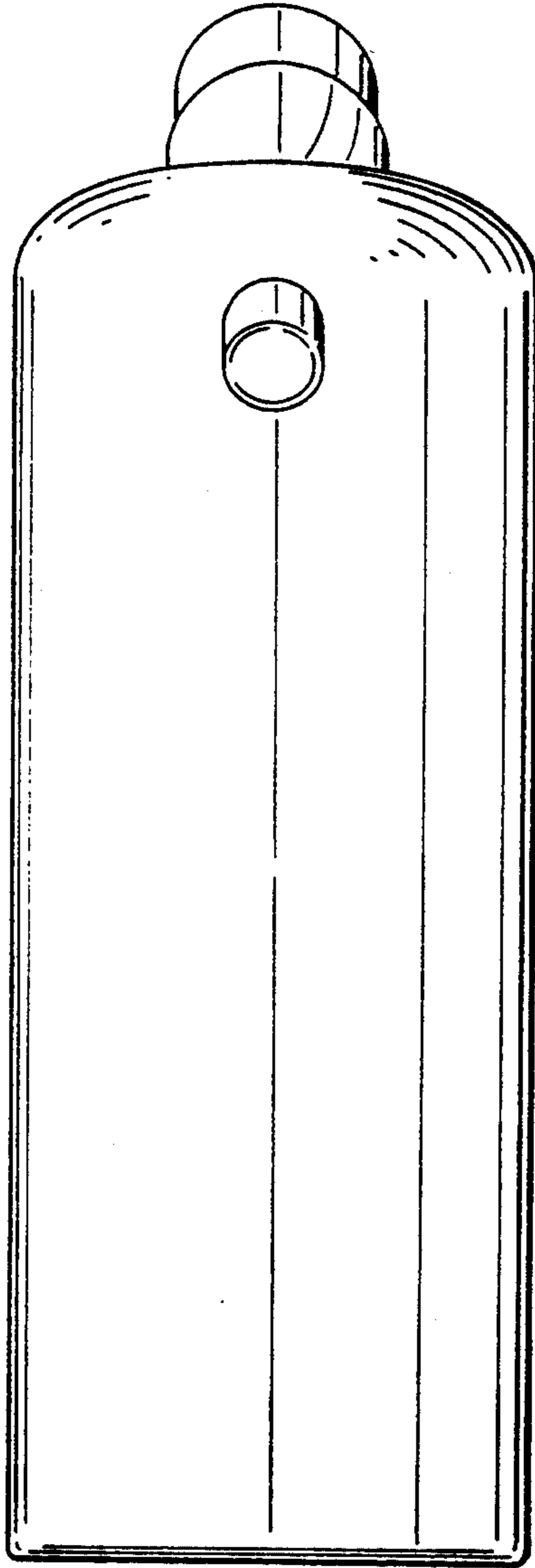

FIG.-5