



US00D336583S

# United States Patent [19]

Van Pinkerton, Jr.

[11] Patent Number: **Des. 336,583**

[45] Date of Patent: **\*\* Jun. 22, 1993**

- [54] TELEPHONE BOOTH
- [75] Inventor: **Stevens Van Pinkerton, Jr., St. Joseph, Mo.**
- [73] Assignee: **Acoustics Development Corporation, St. Joseph, Mo.**
- [\*\*] Term: **14 Years**
- [21] Appl. No.: **641,085**
- [22] Filed: **Jan. 14, 1991**
- [52] U.S. Cl. .... **D6/555; D6/567**
- [58] Field of Search ..... **D6/553, 555, 567-571; 108/33, 150, 152; 312/100; 52/27, 36, 40; 379/428, 435, 437, 440**

D. 297,491	9/1988	Jeanson et al. ....	D6/555
4,323,290	4/1986	Hickman et al. ....	312/100
4,332,205	6/1982	Corl, Jr. ....	D6/567 X
4,754,582	7/1988	Cameron ....	D6/555 X

*Primary Examiner*—Brian N. Vinson  
*Attorney, Agent, or Firm*—Michael Yakimo, Jr.; D. A. N. Chase; Richard P. Stitt

### [57] CLAIM

The ornamental design for a telephone booth, as shown and described.

### DESCRIPTION

FIG. 1 is a front elevational view of a telephone booth showing my new design;  
 FIG. 2 is a rear elevational view thereof;  
 FIG. 3 is a top plan view thereof;  
 FIG. 4 is a right side elevational view thereof, the left side being a mirror image of that shown;  
 FIG. 5 is a top, front, and right side perspective view thereof; and,  
 FIG. 6 is a bottom plan view thereof.

- [56] **References Cited**
- U.S. PATENT DOCUMENTS**
- D. 275,632 9/1984 Lebowitz ..... D6/555
- D. 276,296 11/1984 Cooper ..... D6/555
- D. 296,740 7/1988 Altman ..... D6/555

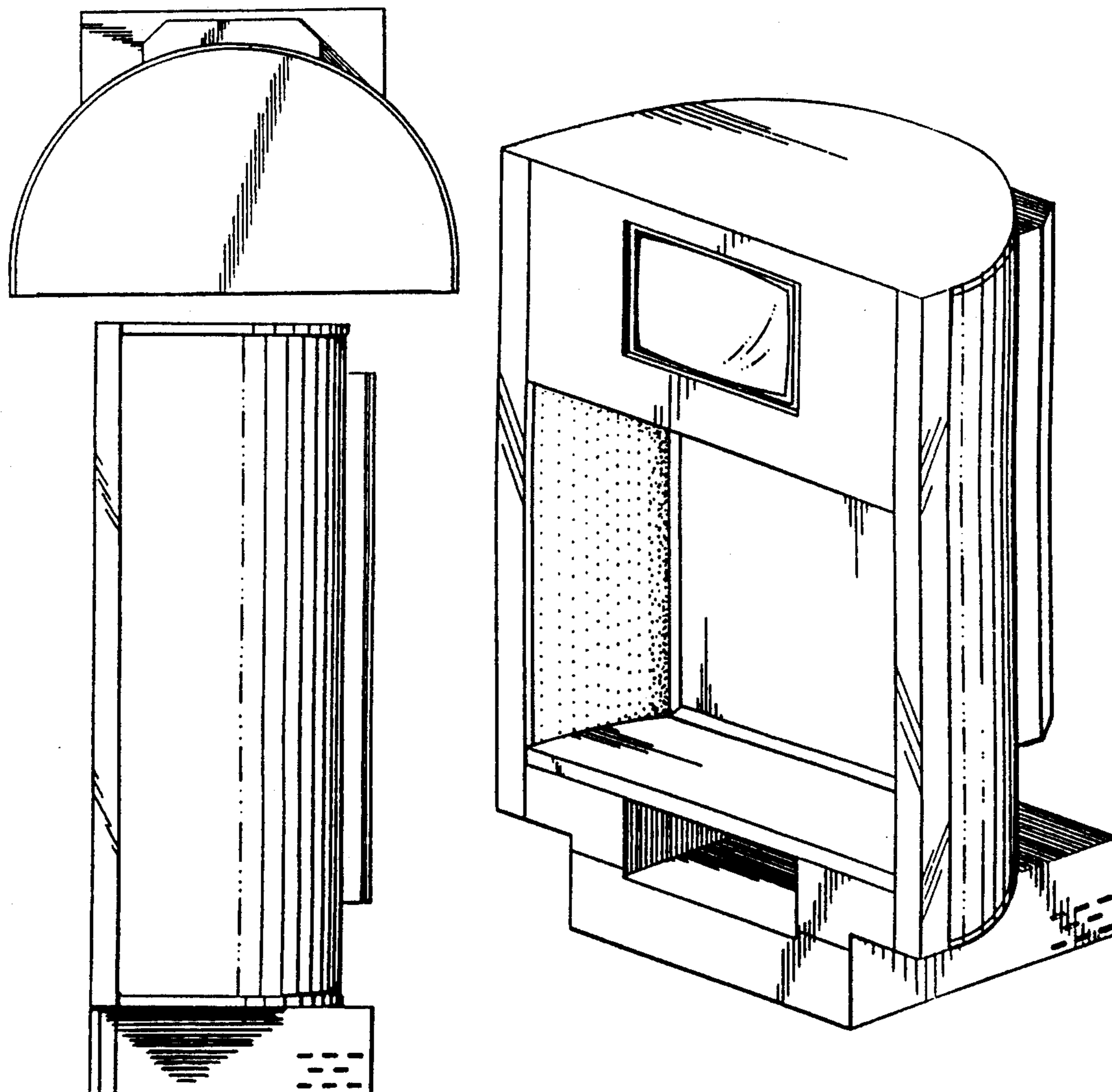

FIG. 1

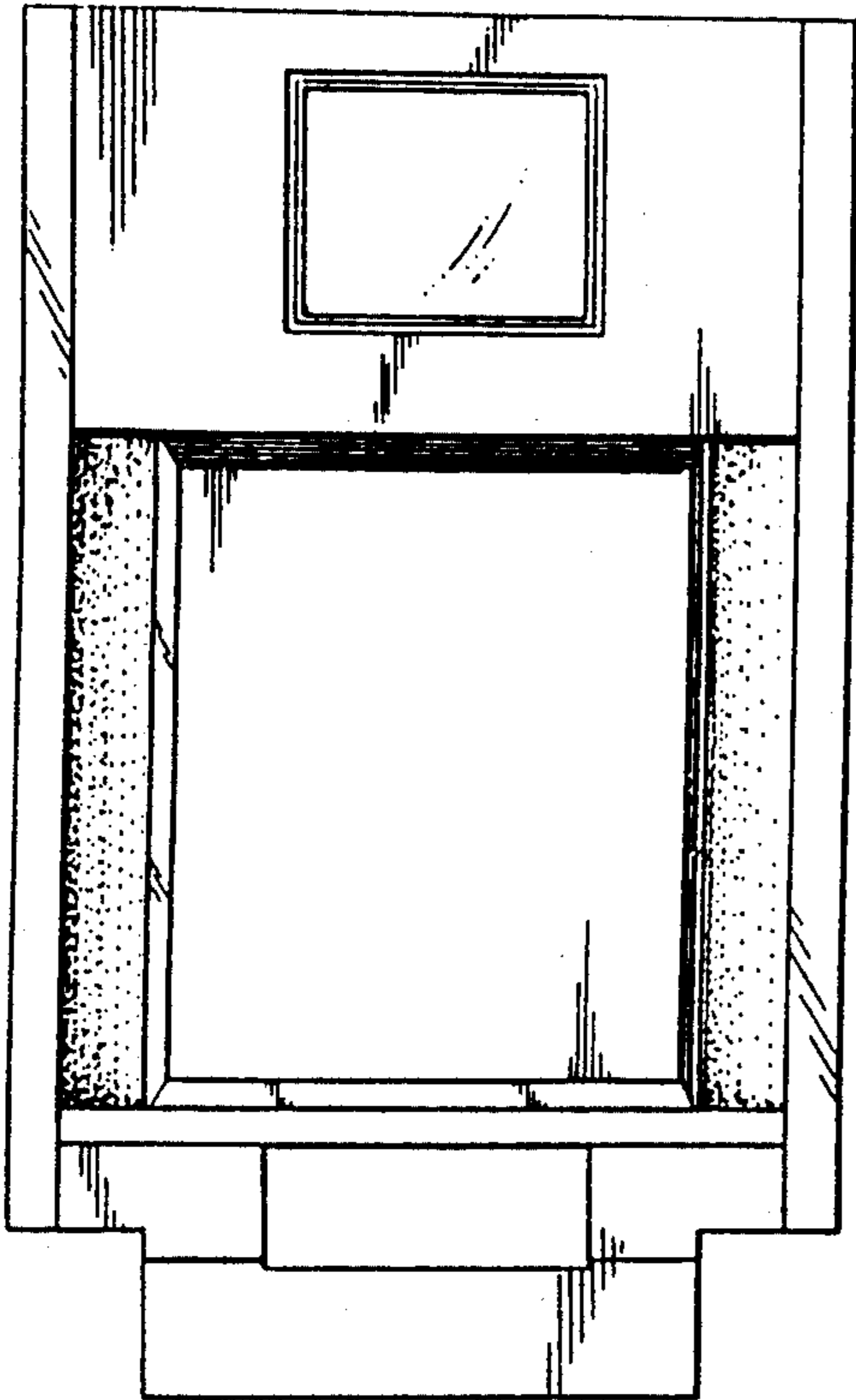

FIG. 2

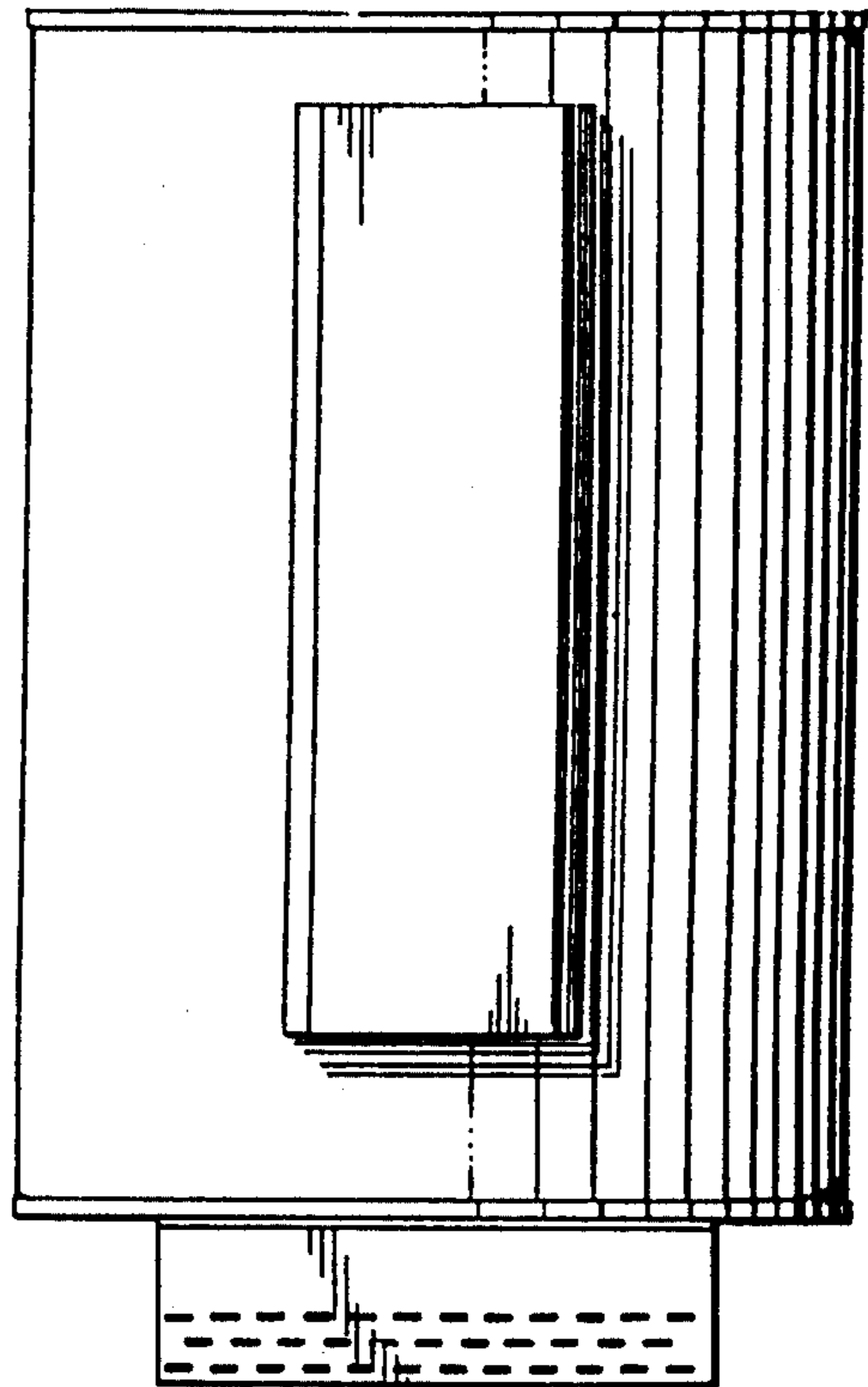

FIG. 3

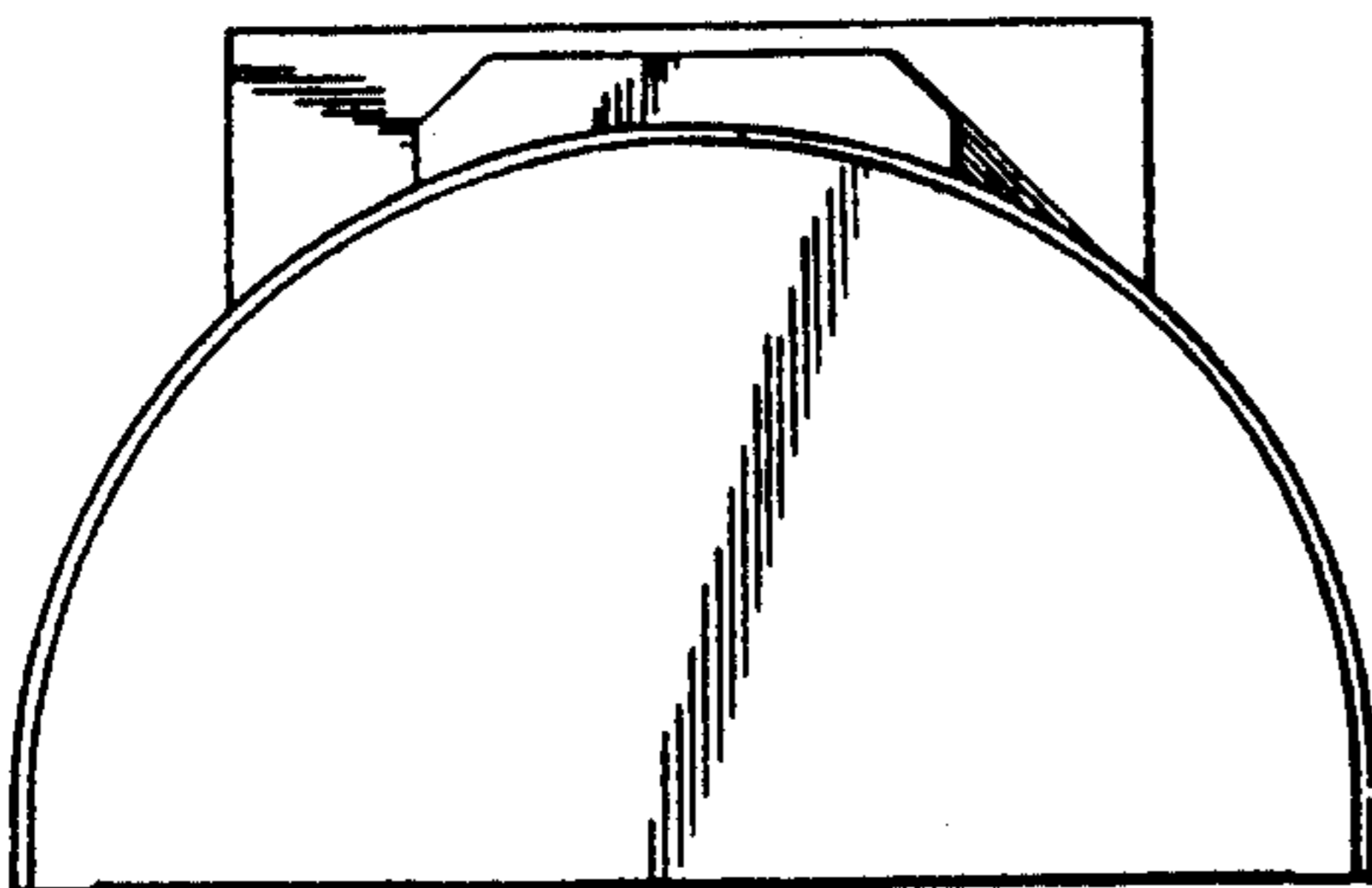

FIG. 4

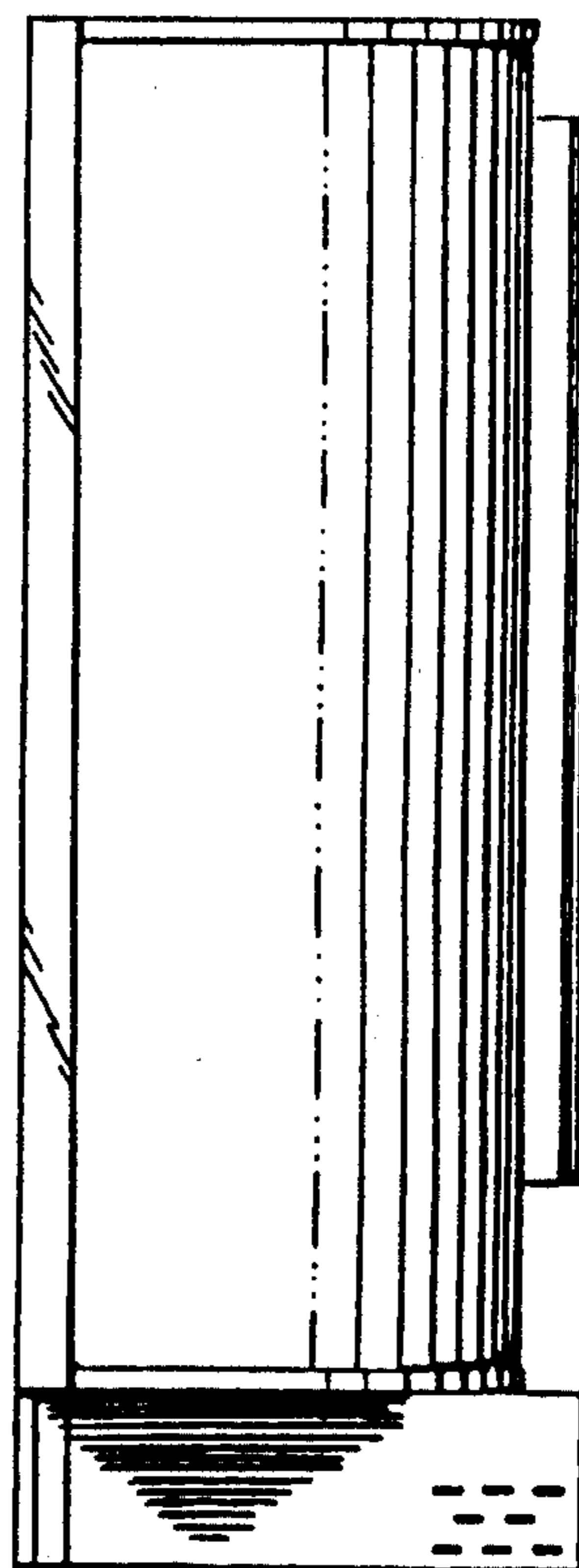

FIG. 5

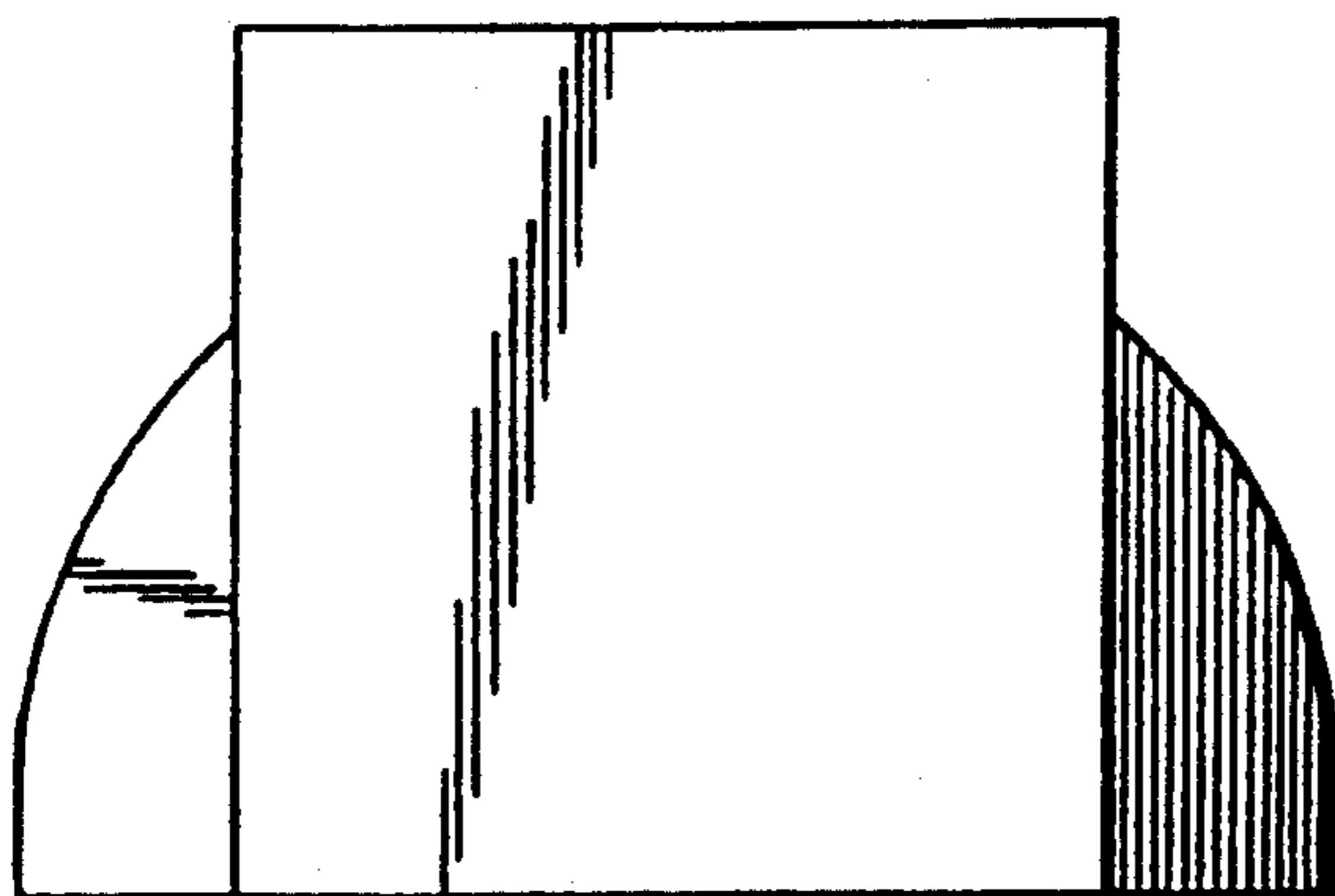
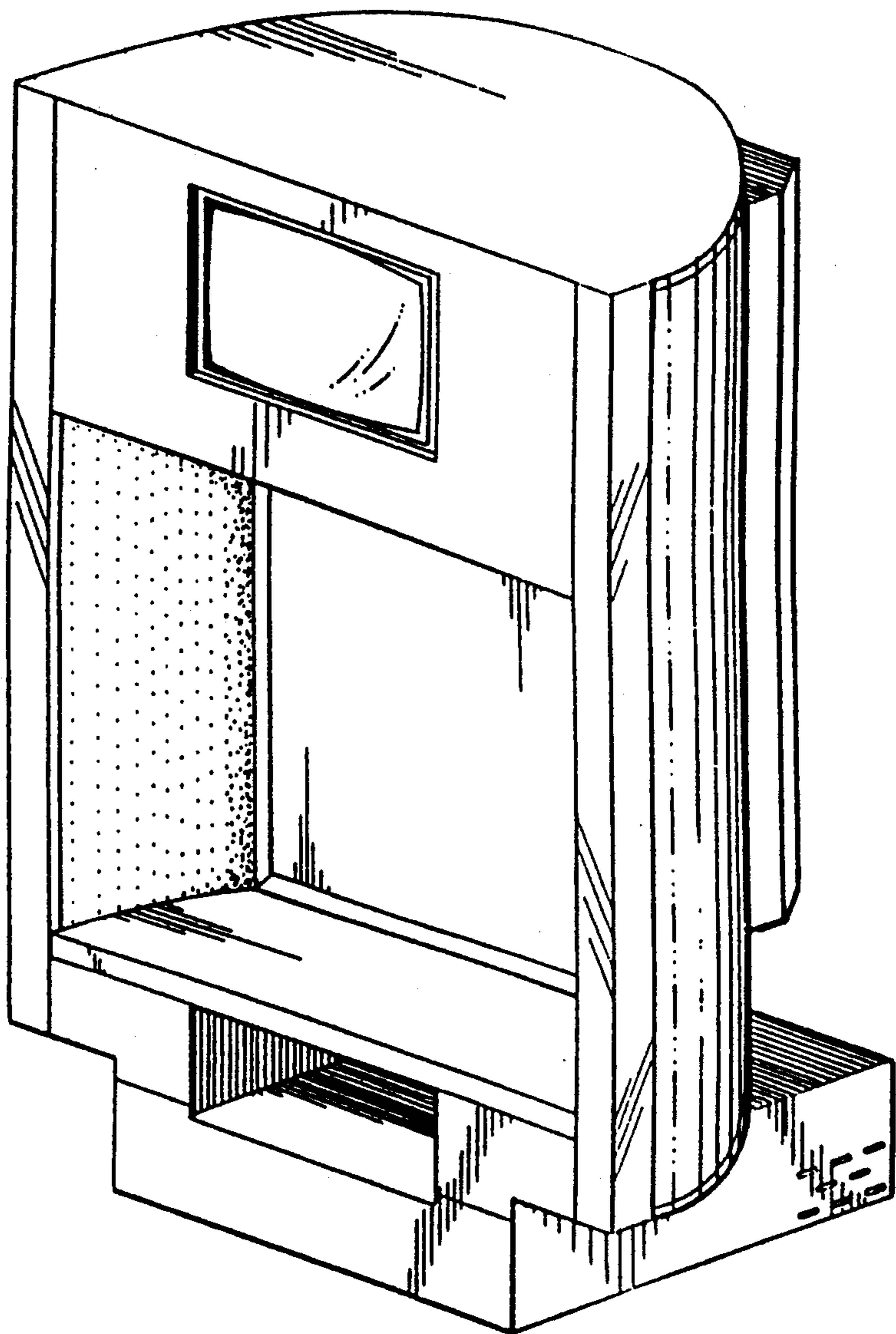

FIG. 6