



US00D336577S

# United States Patent [19]

Celestina et al.

[11] Patent Number: **Des. 336,577**

[45] Date of Patent: **\*\* Jun. 22, 1993**

[54] **SIDEGUARD FOR A BIRTHING BED**

5,129,117 7/1992 Celestina et al. .... 5/424 X

[75] Inventors: **Mary A. Celestina; Richard L. Borders**, both of Cincinnati, Ohio

*Primary Examiner*—Nelson C. Holtje  
*Assistant Examiner*—J. E. Seeger  
*Attorney, Agent, or Firm*—Wood, Herron & Evans

[73] Assignee: **Hill-Rom Company, Inc.**, Batesville, Ind.

[57] **CLAIM**

[\*\*] Term: **14 Years**

The ornamental design for a sideguard for a birthing bed, as shown and described.

[21] Appl. No.: **627,964**

**DESCRIPTION**

[22] Filed: **Dec. 17, 1990**

[52] U.S. Cl. .... **D6/503; D6/491**

[58] Field of Search ..... **D6/491, 492, 494-496, D6/500-502; D24/183, 184; 5/424, 425, 426, 444, 443, 503.1**

FIG. 1 is a perspective view of a sideguard for a birthing bed, showing our new design; FIG. 2 is a side elevational view; FIG. 3 is an elevational view, showing the side opposite that shown in FIG. 2; FIG. 4 is an end elevational view; FIG. 5 is an elevational view, showing the end not shown in FIG. 4; FIG. 6 is a top plan view; and, FIG. 7 is a bottom plan view thereof.

[56] **References Cited**

**U.S. PATENT DOCUMENTS**

4,183,015	1/1980	Drew et al. ....	5/425 X
4,484,367	11/1984	Jenkins .....	5/503.1 X
4,592,104	6/1986	Foster et al. ....	5/425 X
5,077,843	1/1992	Foster et al. ....	5/503.1 X

The broken lines in FIG. 1 are for environmental purposes only and form no part of the claimed design.

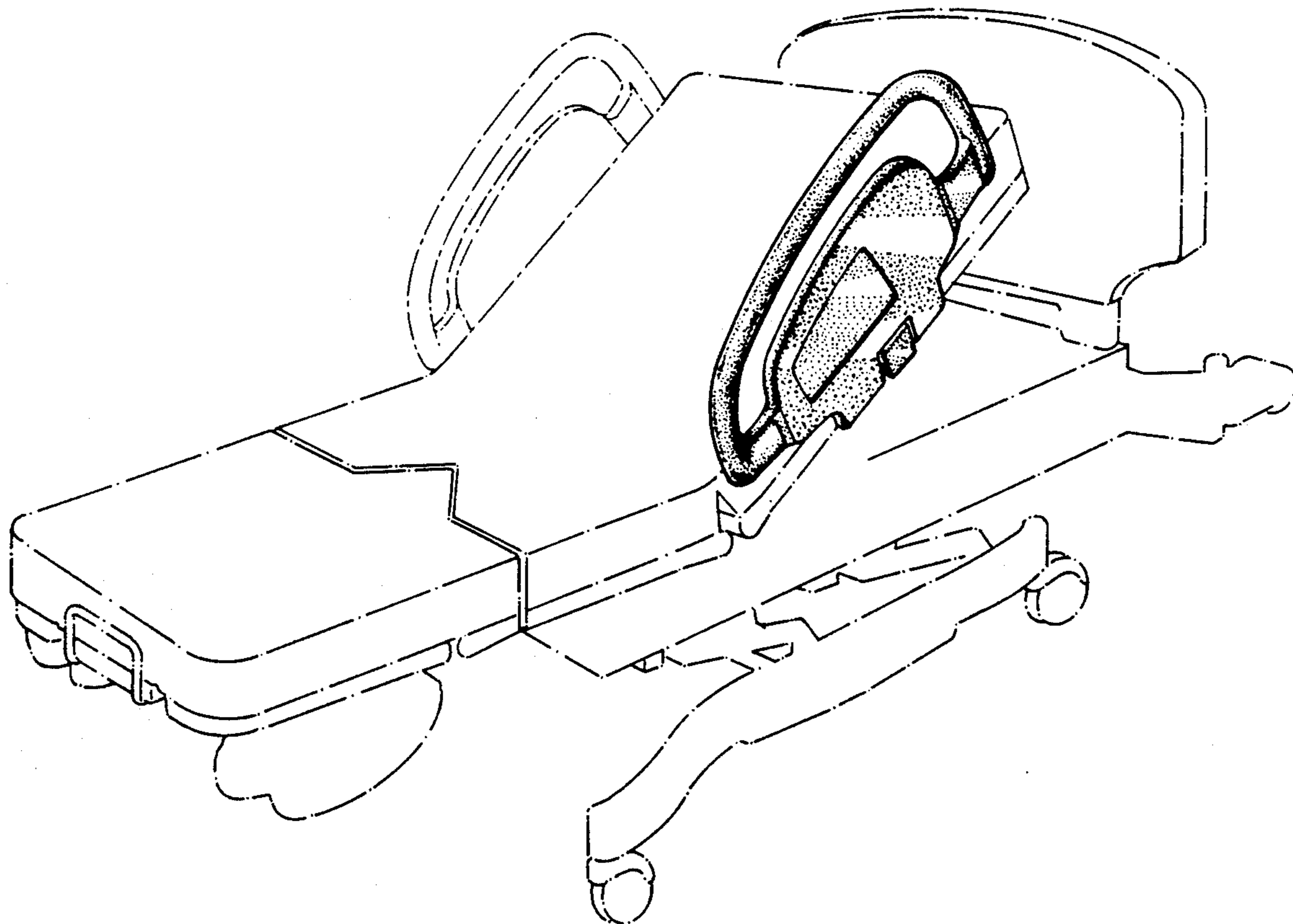

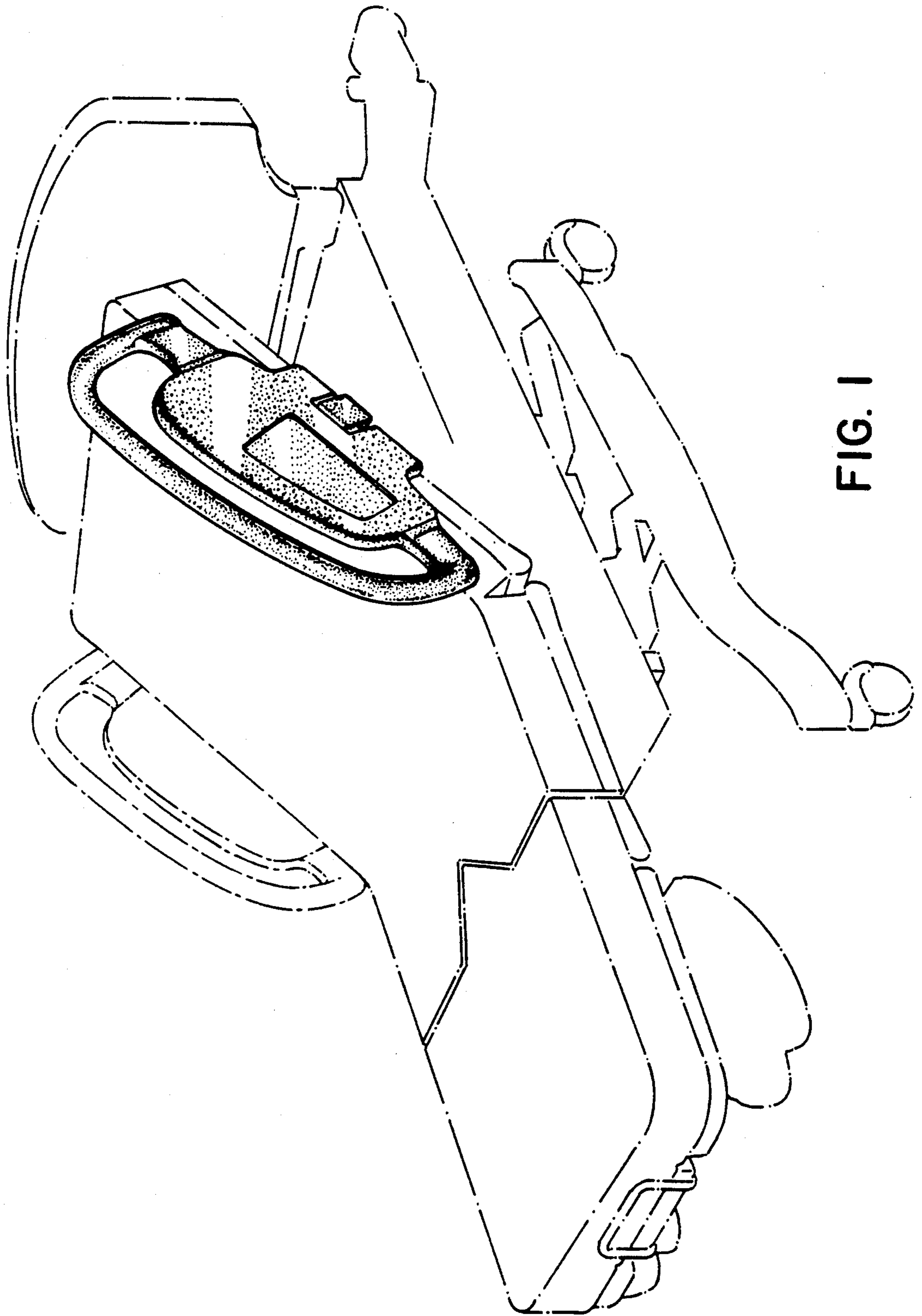

FIG. 1



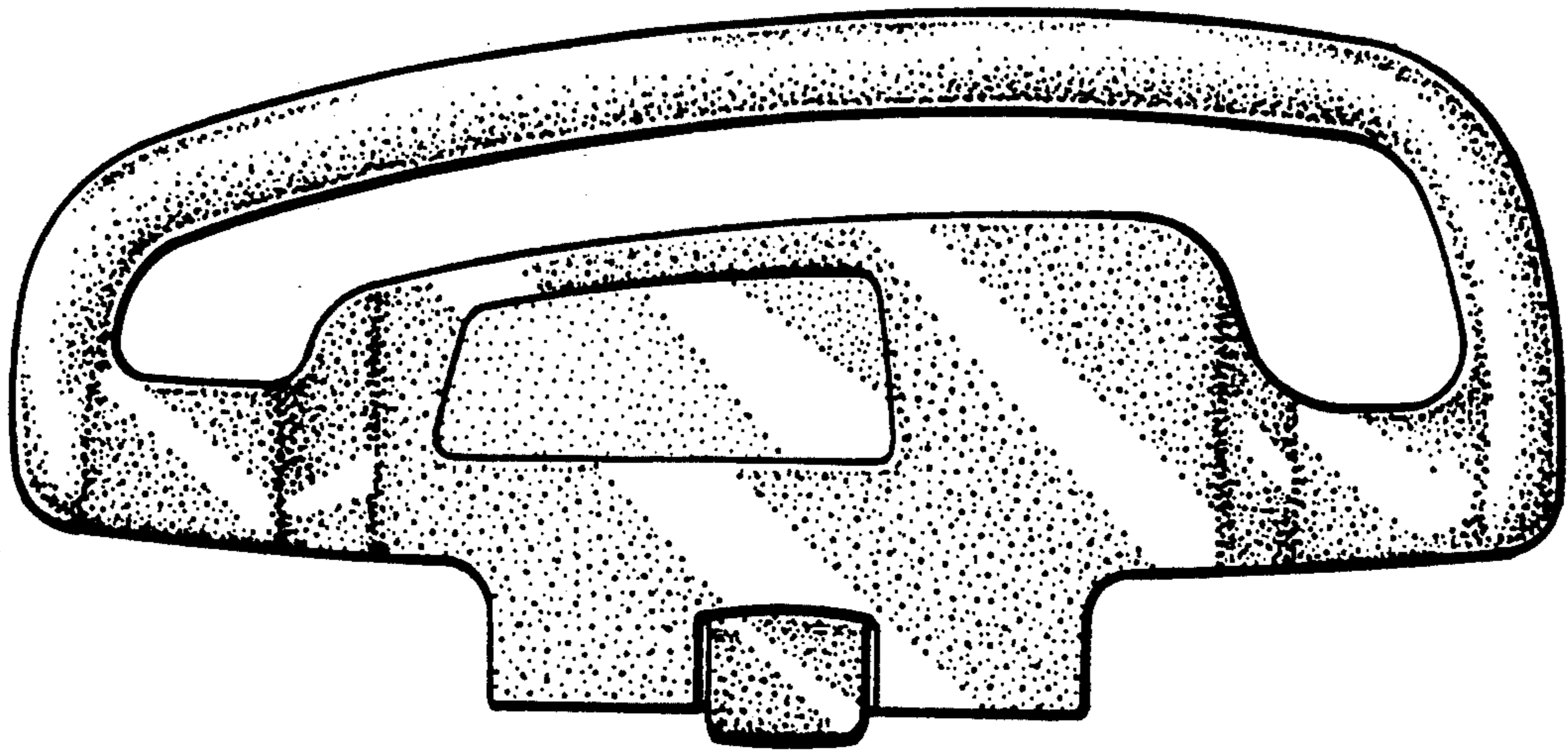

FIG. 2

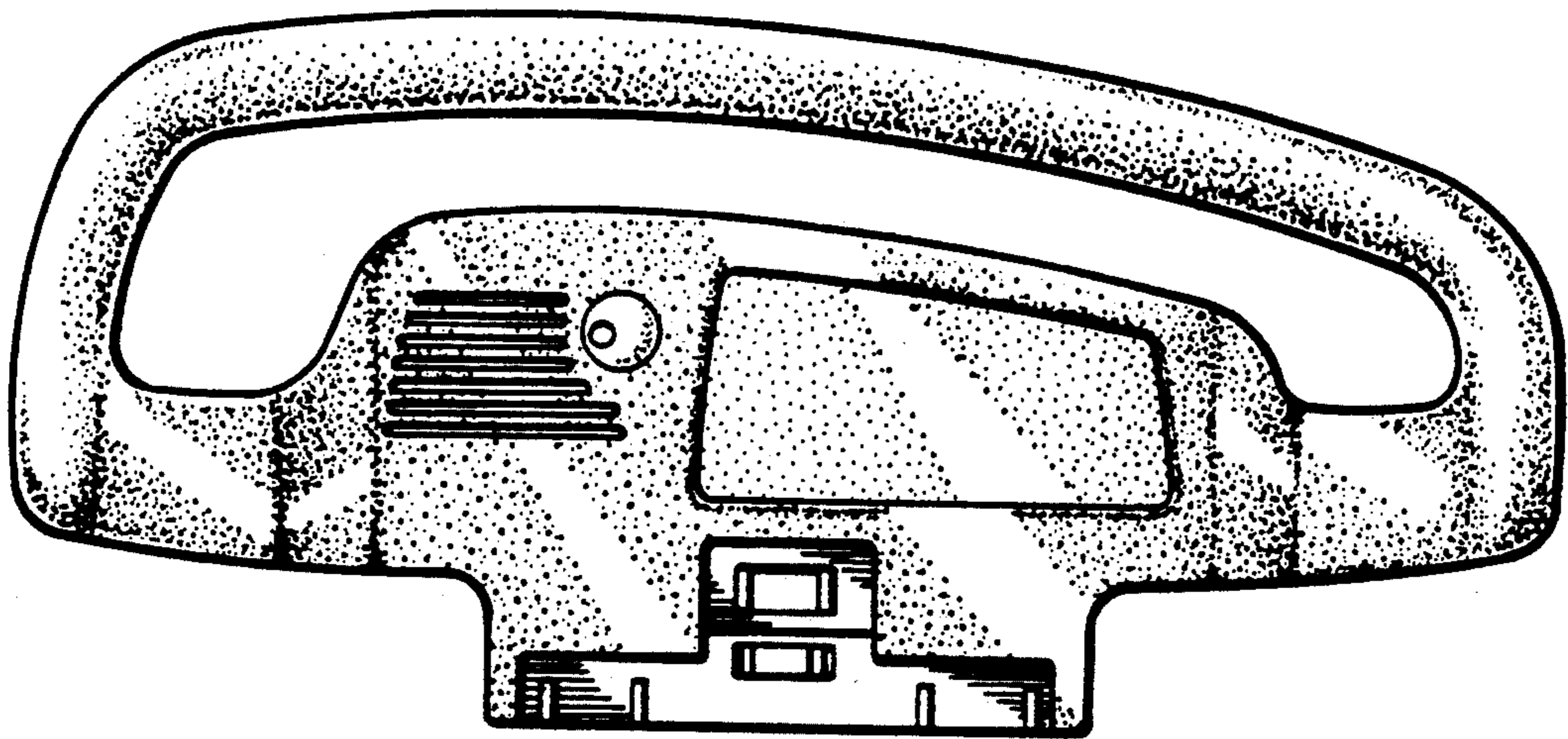

FIG. 3

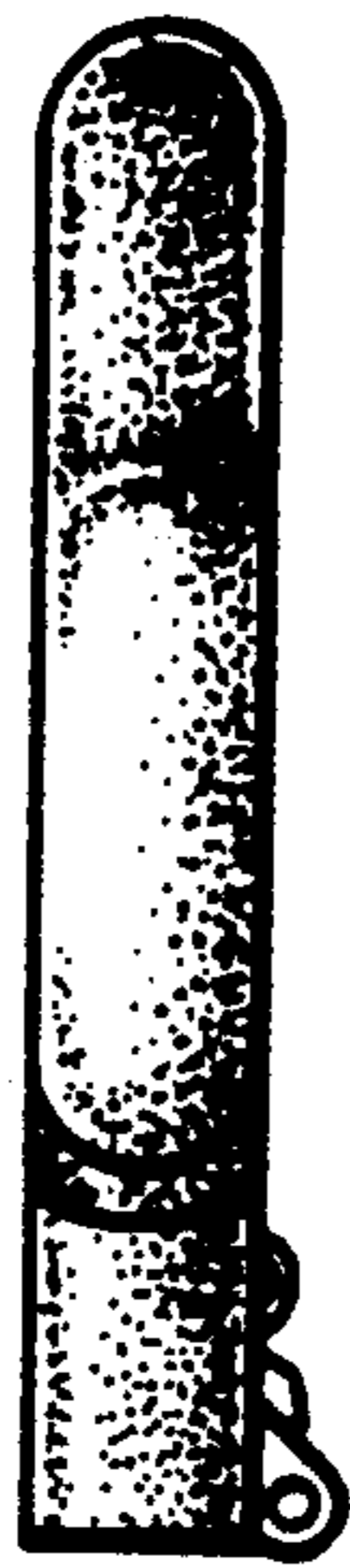

FIG. 4



FIG. 5

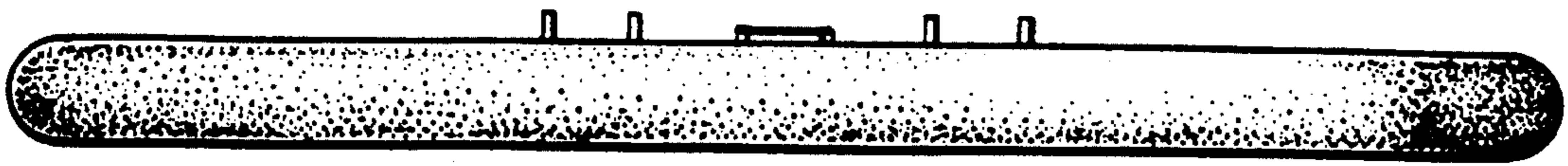

FIG. 6

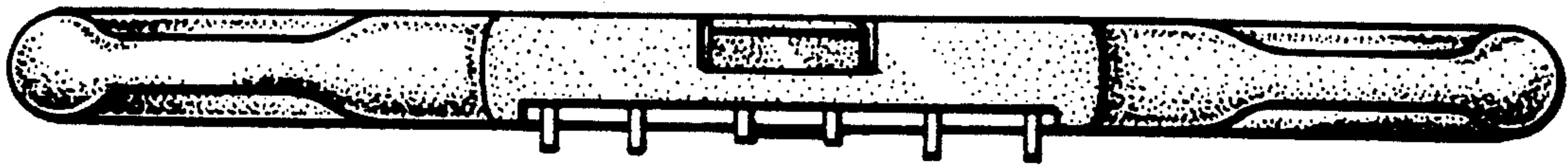

FIG. 7