



US00D336570S

# United States Patent [19] Blake

[11] Patent Number: **Des. 336,570**  
[45] Date of Patent: **\*\* Jun. 22, 1993**

[54] **COVERED CRIB**

[76] Inventor: **Margie Blake**, Box 17, Mesilla Park,  
N. Mex. 88047

[\*\*] Term: **14 Years**

[21] Appl. No.: **679,343**

[22] Filed: **Apr. 2, 1991**

[52] U.S. Cl. .... **D6/390; D6/333**

[58] Field of Search ..... **D6/382-385,  
D6/389-395, 505-508, 338, 333; 5/93.1, 93.2,  
97, 101, 424**

[56] **References Cited**

**U.S. PATENT DOCUMENTS**

2,234,515 3/1941 Carrel et al. .... 5/97  
4,571,760 2/1986 Kassai ..... 5/98.1

*Primary Examiner*—Nelson C. Holtje  
*Assistant Examiner*—J. E. Seeger  
*Attorney, Agent, or Firm*—Leon Gilden

[57] **CLAIM**

The ornamental design for a covered crib, as shown and described.

**DESCRIPTION**

FIG. 1 is a front elevational view of the covered crib showing my new design;  
FIG. 2 is a rear elevational view thereof;  
FIG. 3 is a left side elevational view thereof;  
FIG. 4 is a right side elevational view thereof;  
FIG. 5 is a top plan view thereof;  
FIG. 6 is a bottom plan view thereof; and,  
FIG. 7 is a perspective view thereof.

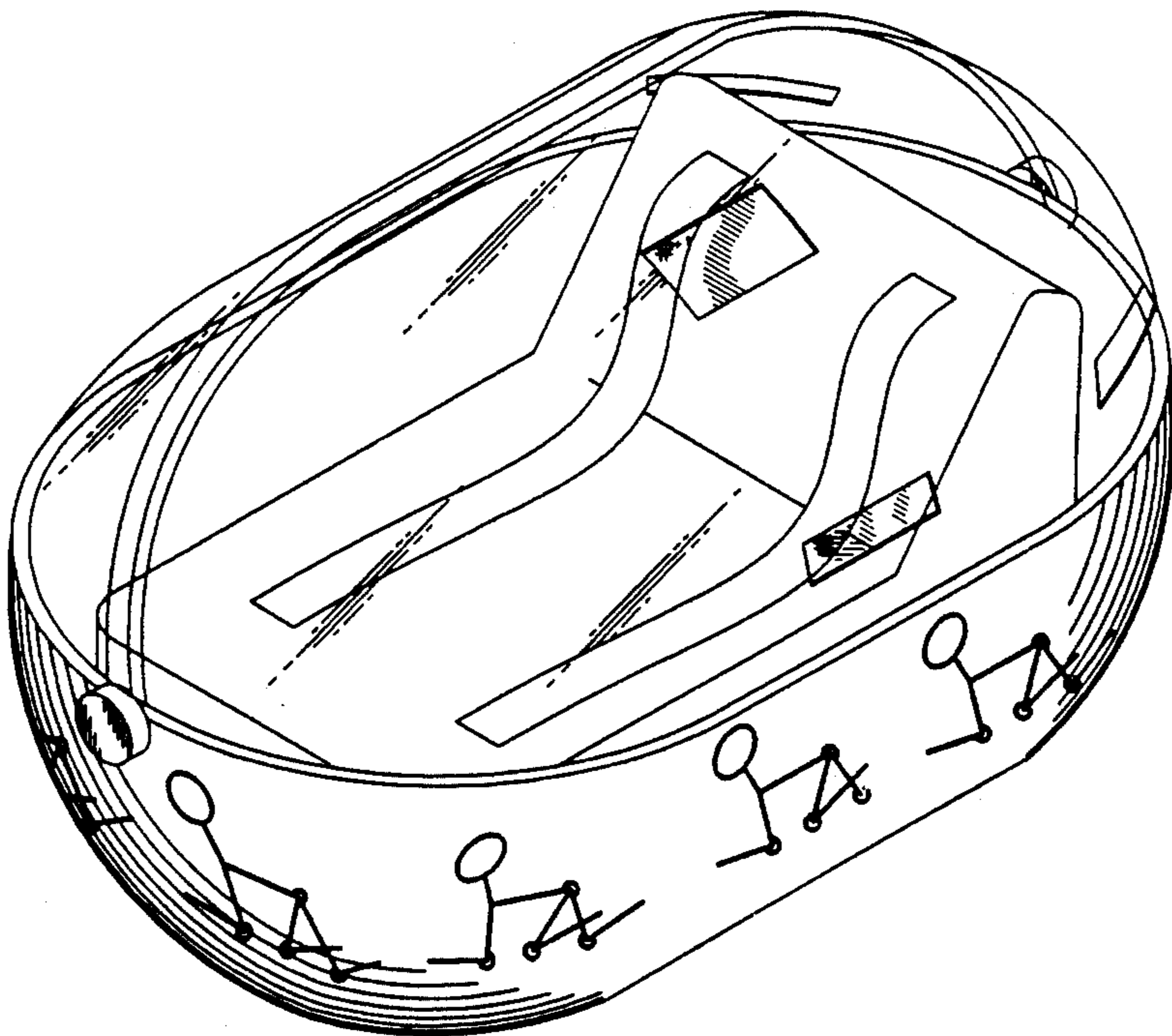
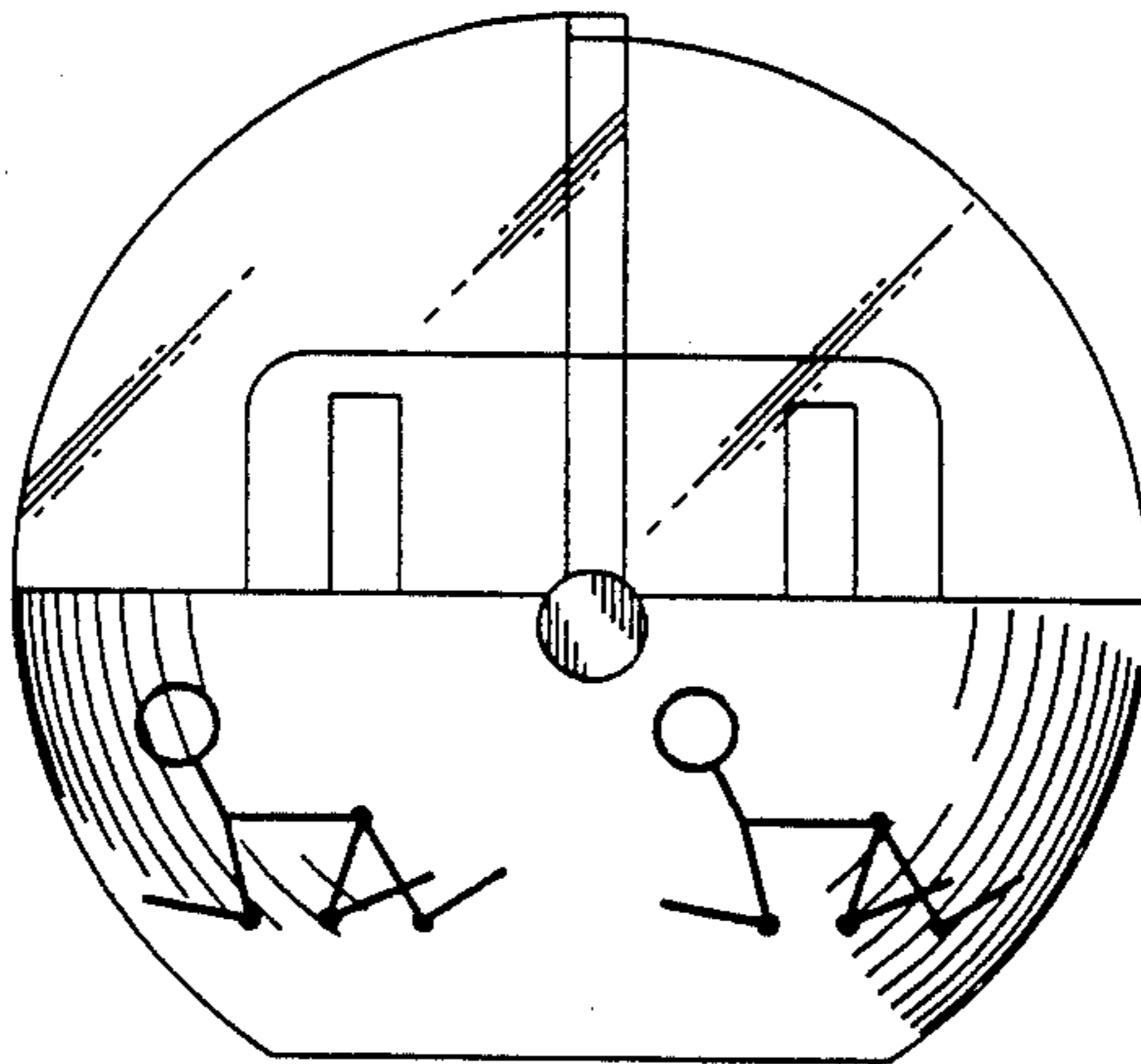

FIG. 1

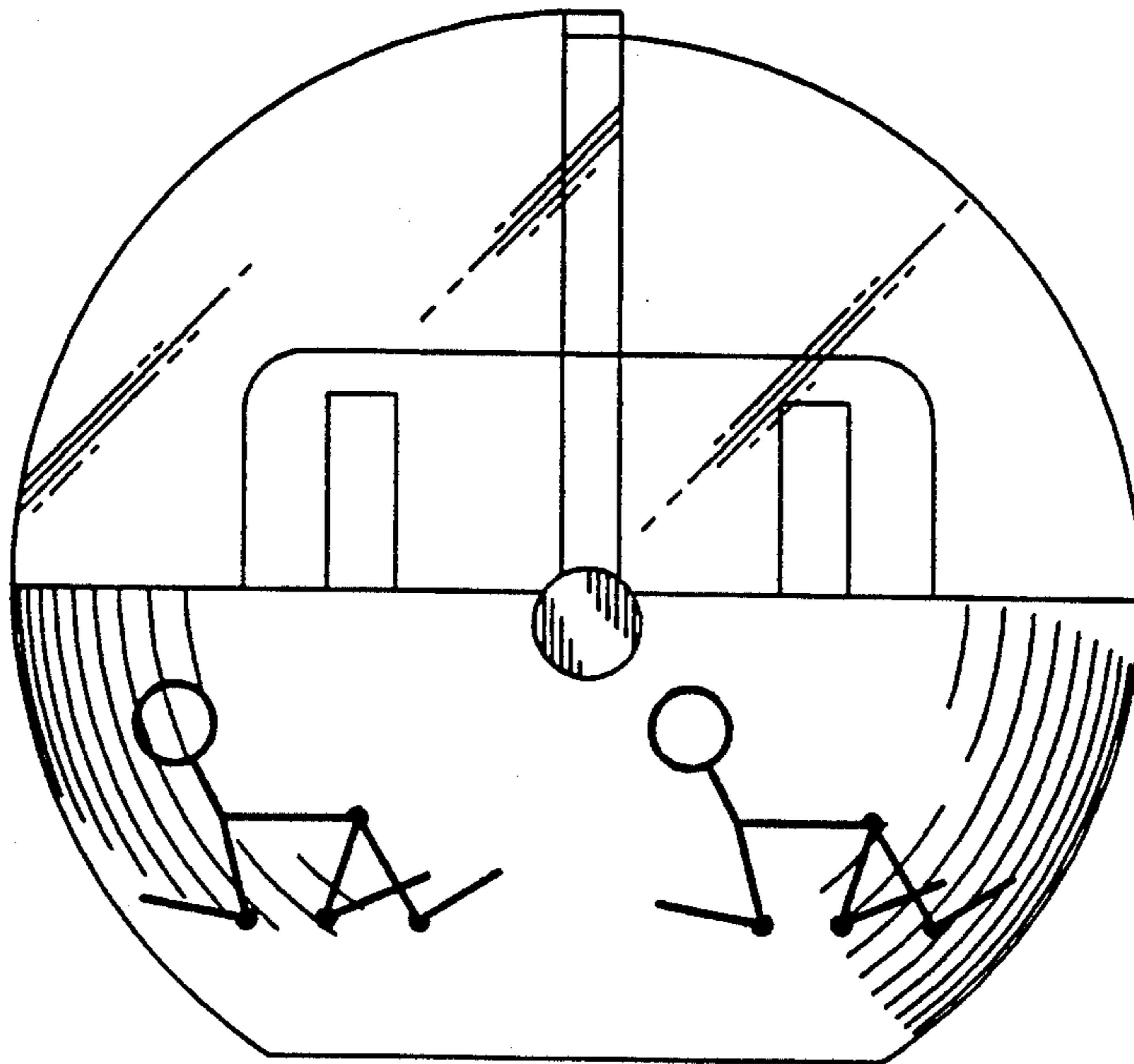

FIG. 2

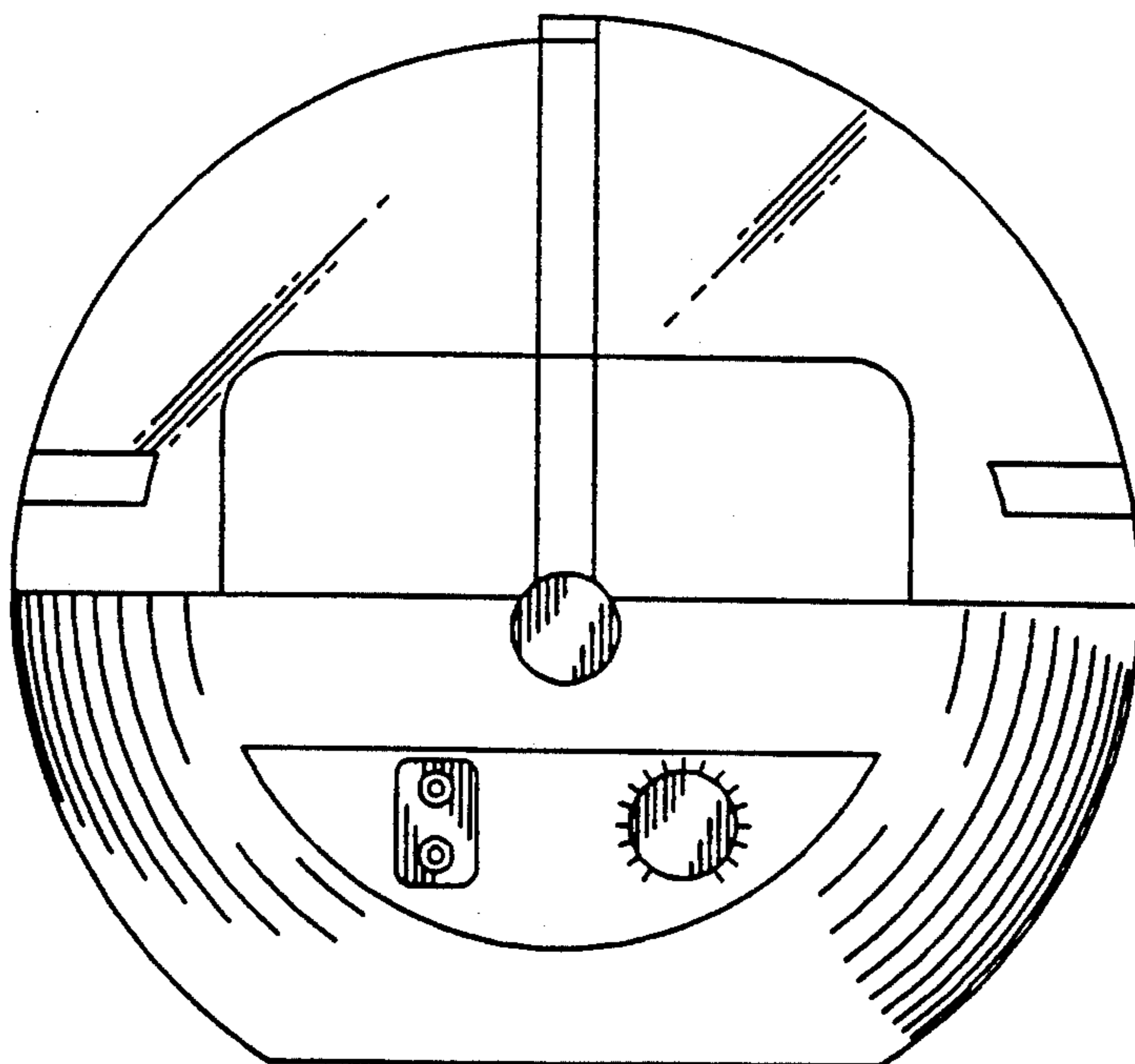

FIG. 3

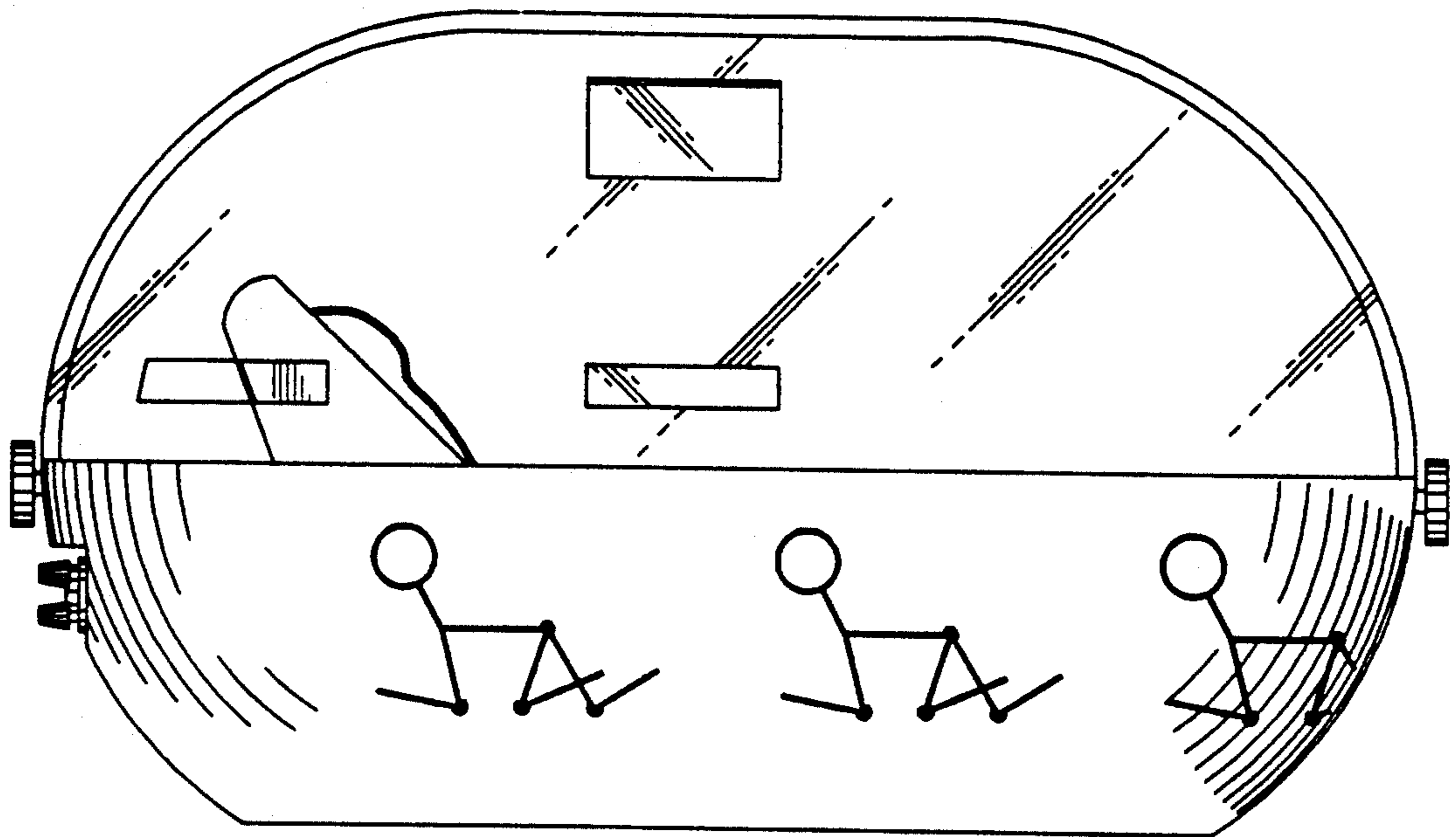

FIG. 4

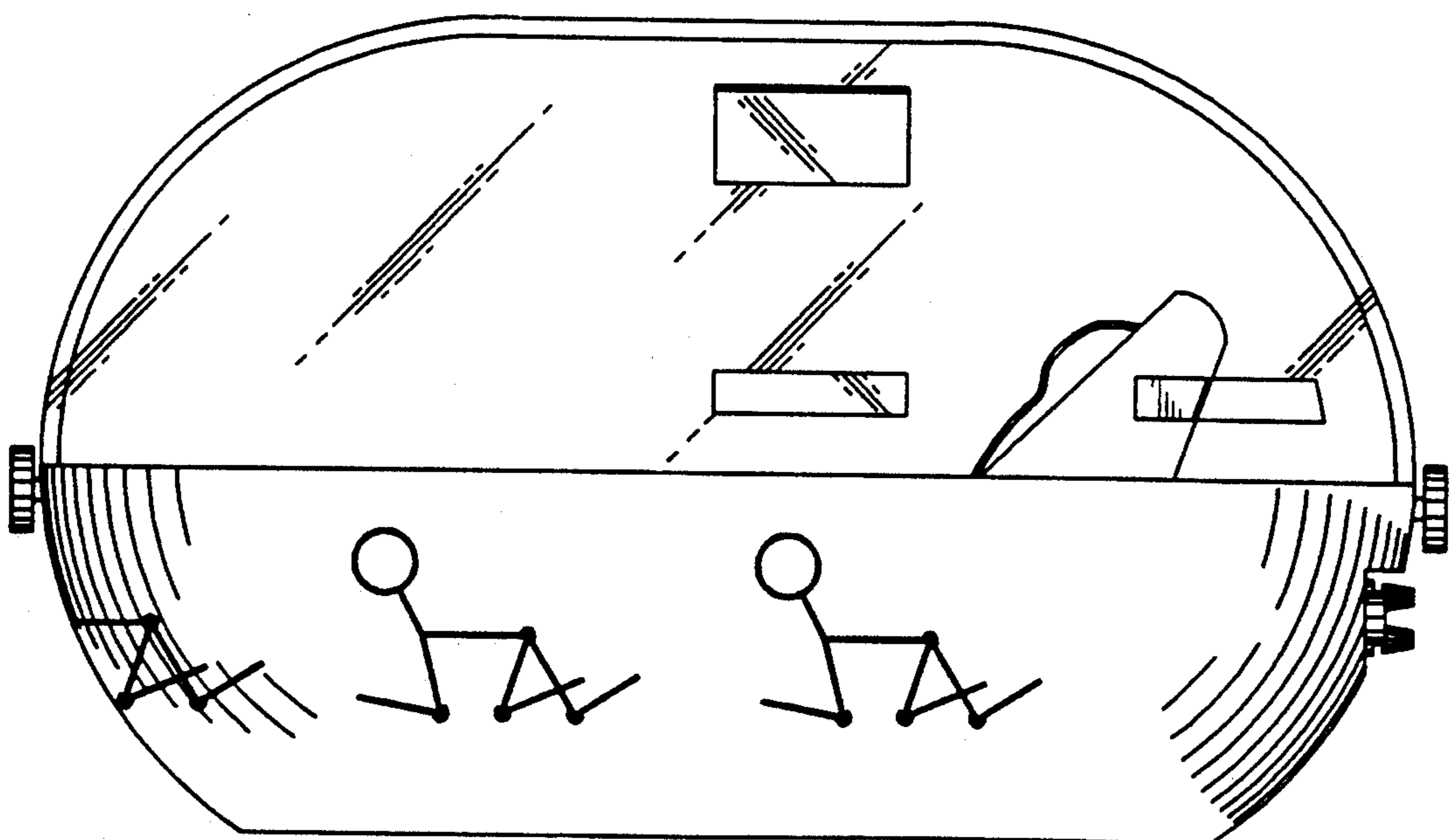

FIG. 5

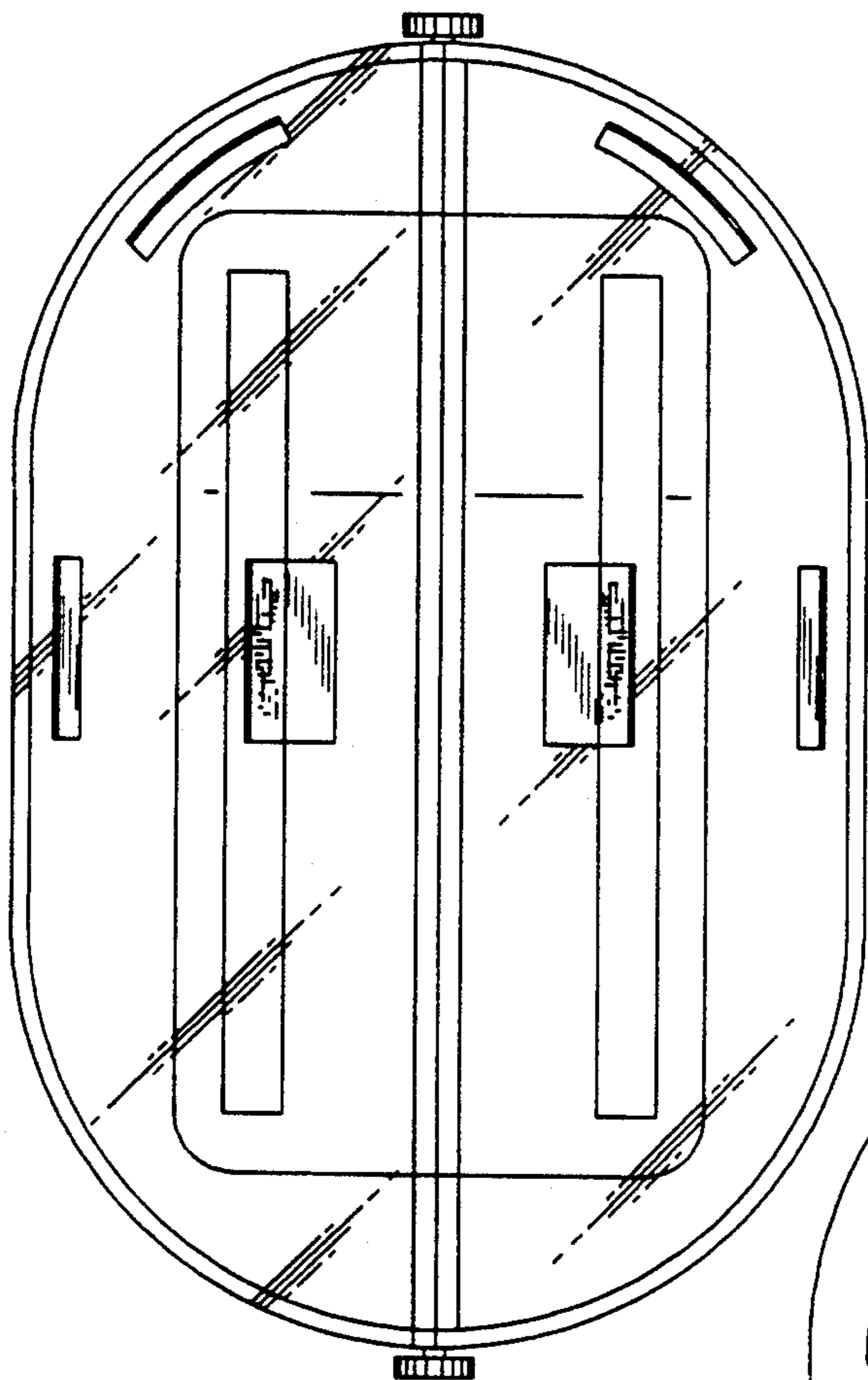

FIG. 6

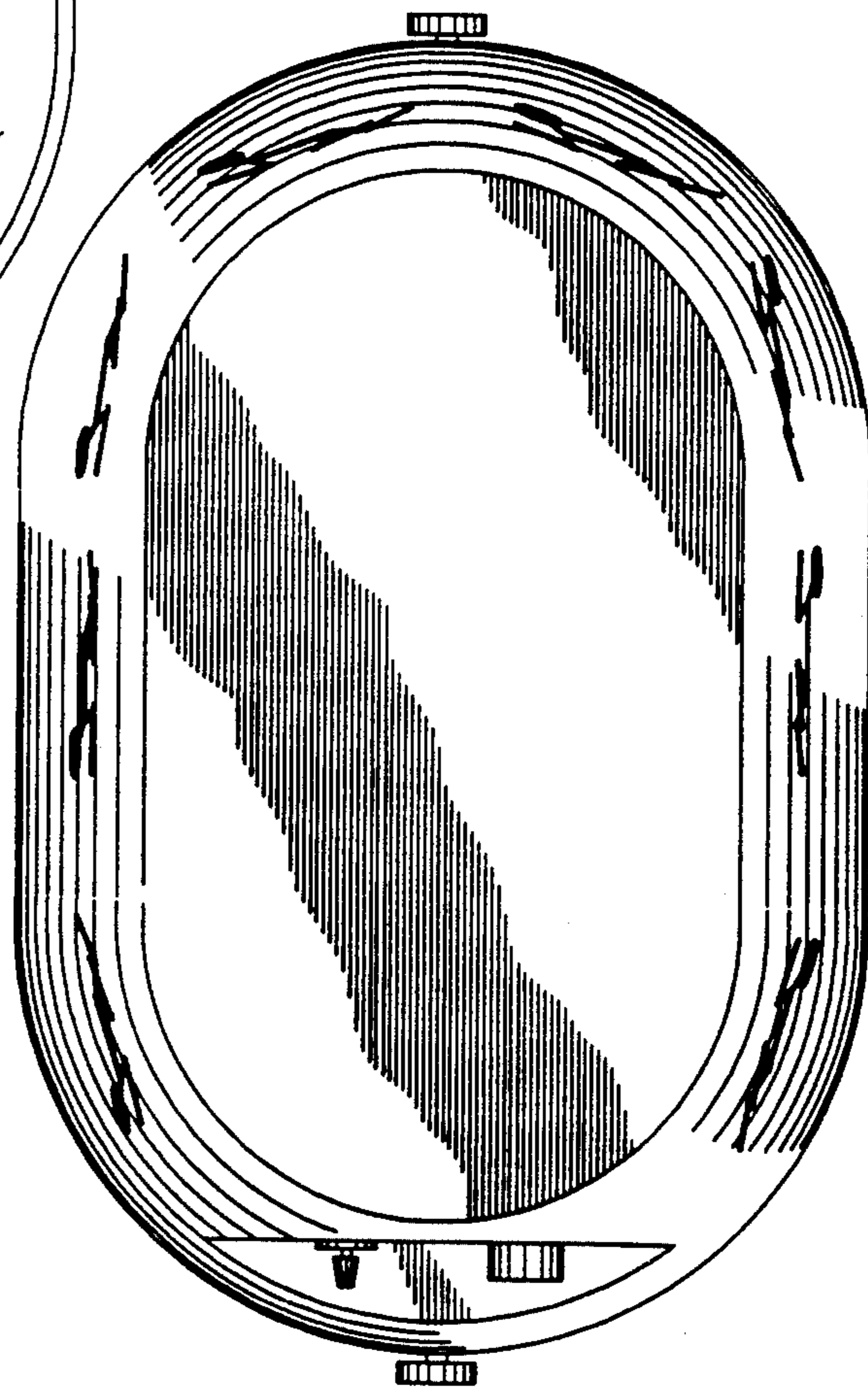

FIG. 7

