



US00D336385S

# United States Patent [19]

[11] Patent Number: Des. 336,385

Gibbs

[45] Date of Patent: \*\* Jun. 15, 1993

[54] CHAIR

[75] Inventor: Terence Gibbs, Nyack, N.Y.

[73] Assignee: Omni Products International, Inc.,  
Fairfield, N.J.

[\*\*] Term: 14 Years

[21] Appl. No.: 574,597

[22] Filed: Aug. 28, 1990

[52] U.S. Cl. .... D6/379; D6/375

[58] Field of Search ..... D6/334, 369, 370, 373,  
D6/374, 375, 376, 379, 500, 501, 502; 297/445

[56] **References Cited**

**U.S. PATENT DOCUMENTS**

D. 86,793	4/1932	McGowen	.....	D6/373
D. 142,758	10/1945	Weill	.....	D6/375
D. 145,678	10/1946	Roth	.....	D6/375
D. 289,349	4/1987	Vanderminden	.....	D6/379
D. 294,089	2/1988	Klein	.....	D6/379
D. 296,848	7/1988	Colby	.....	D6/379
D. 323,250	1/1992	Leib	.....	D6/373
4,826,248	5/1989	Poo	.....	D6/370 X
5,094,507	3/1992	Gibbs	.....	D6/379 X

**OTHER PUBLICATIONS**

Furniture South, Jun. 1942, p. 11, Chair at right in bottom left frame.

Sun Terrace Products, 1986, p. 9, Chair at bottom left.

*Primary Examiner*—Alan P. Douglas

*Assistant Examiner*—Gary D. Watson

*Attorney, Agent, or Firm*—Lerner, David, Littenberg, Krumholz & Mentlik

[57] **CLAIM**

The ornamental design for a chair, as shown and described.

**DESCRIPTION**

FIG. 1 is a perspective view, looking from above, of a chair showing my new design;  
 FIG. 2 is a front elevational view thereof;  
 FIG. 3 is a rear elevational view thereof;  
 FIG. 4 is a right side elevational view thereof;  
 FIG. 5 is a left side elevational view thereof;  
 FIG. 6 is a top plan view thereof;  
 FIG. 7 is a bottom plan view thereof;  
 FIG. 8 is a perspective view, looking from above, of a chair showing another embodiment of my new design;  
 FIG. 9 is a front elevational view thereof;  
 FIG. 10 is a back elevational view thereof;  
 FIG. 11 is a right side elevational view thereof;  
 FIG. 12 is a left side elevational view thereof;  
 FIG. 13 is a top plan view thereof;  
 FIG. 14 is a bottom plan view thereof;  
 FIG. 15 is a perspective view, looking from above, of a chair showing another embodiment of my new design;  
 FIG. 16 is a front elevational view thereof;  
 FIG. 17 is a back elevational view thereof;  
 FIG. 18 is a right side elevational view thereof;  
 FIG. 19 is a left side elevational view thereof;  
 FIG. 20 is a top plan view thereof; and,  
 FIG. 21 is a bottom plan view thereof.

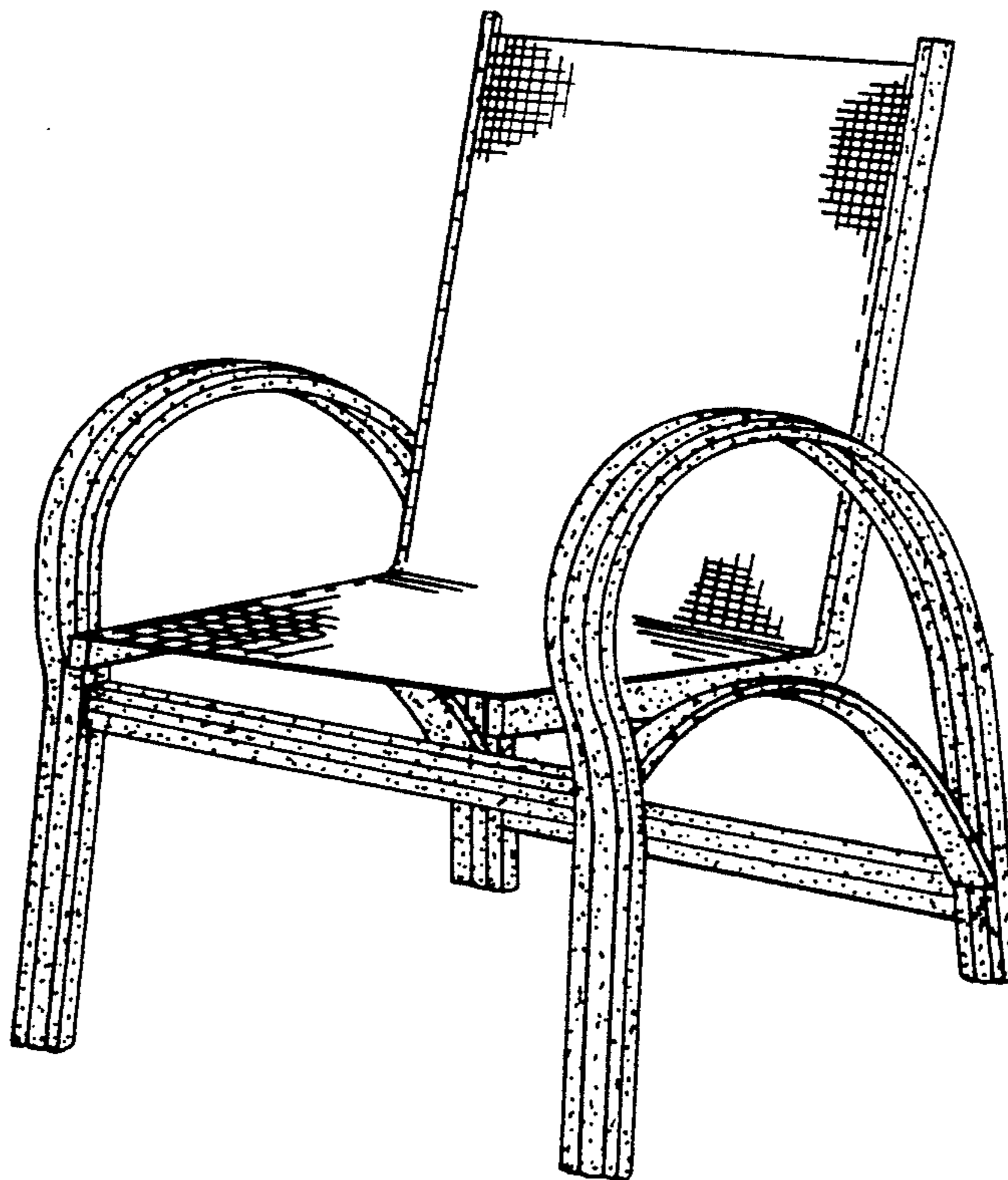

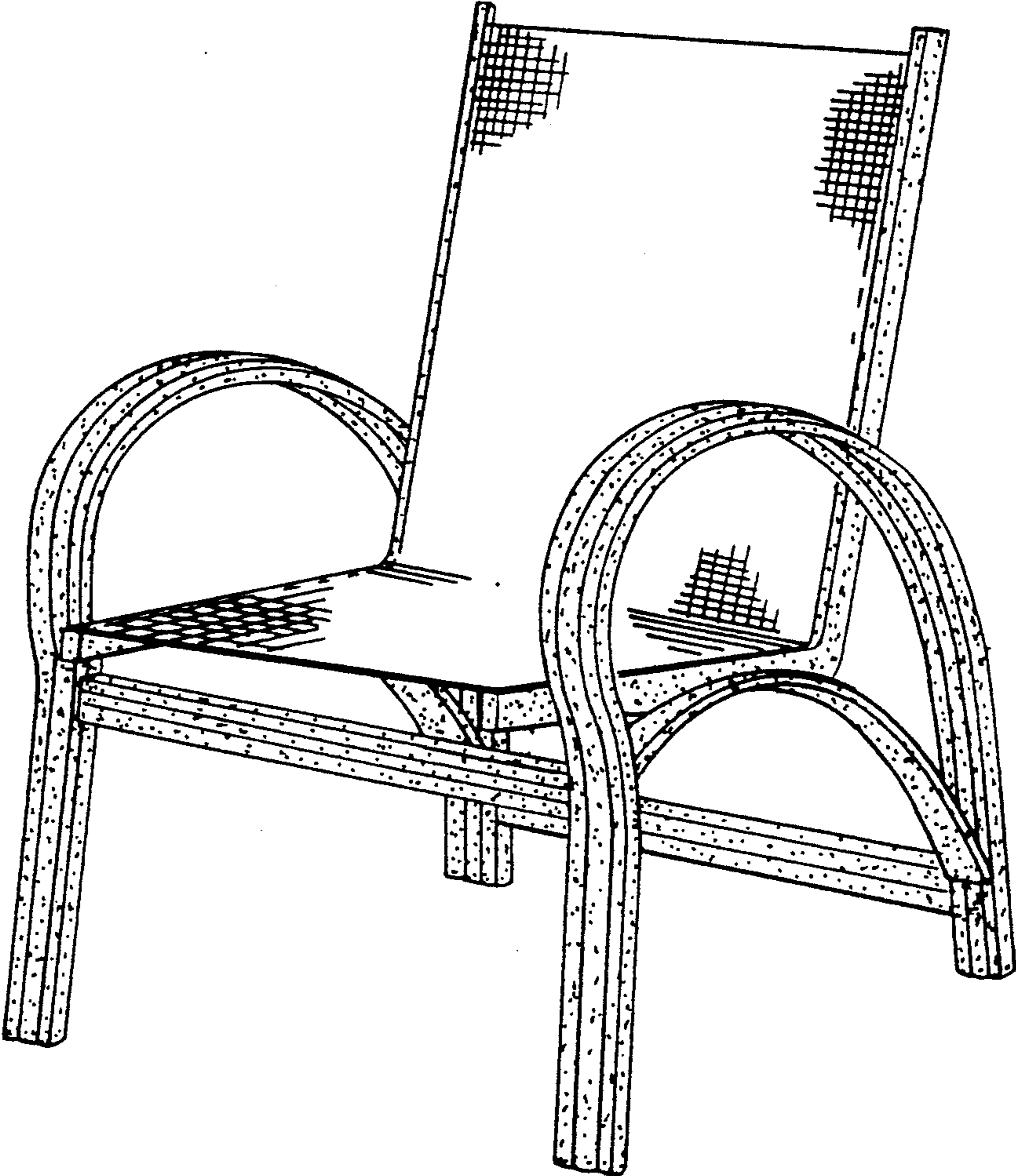

FIG. 1

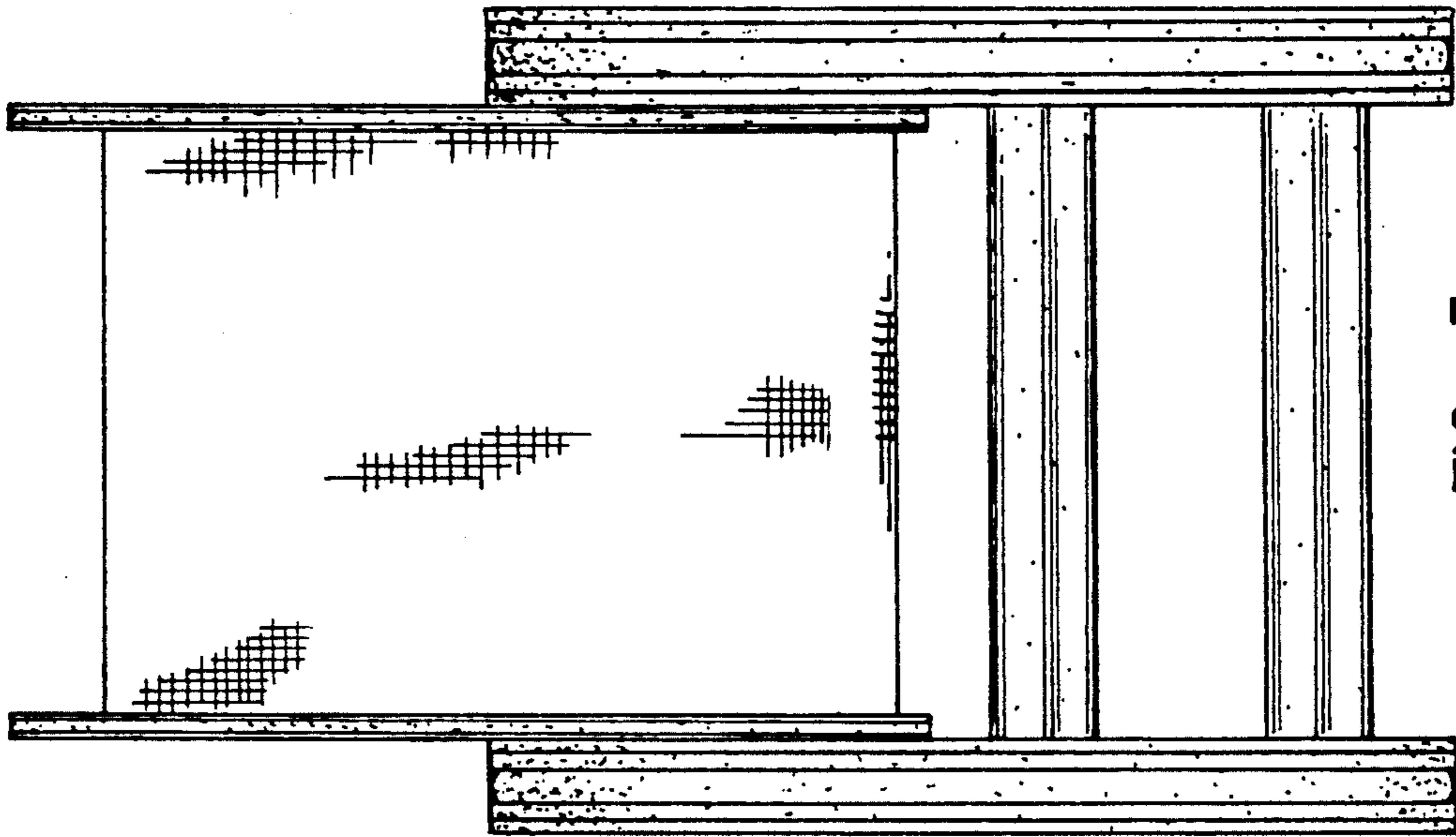

FIG. 3

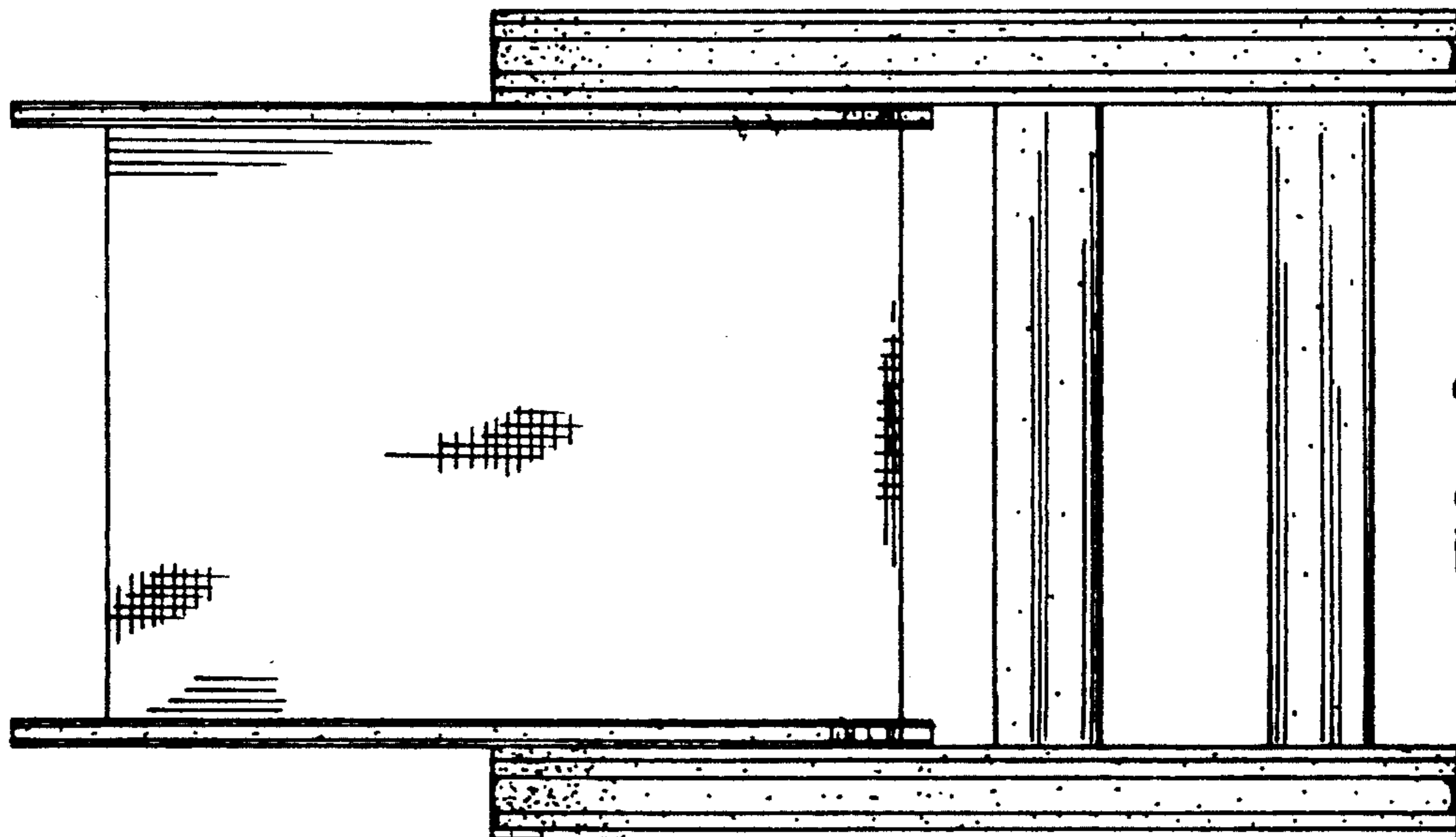

FIG. 2

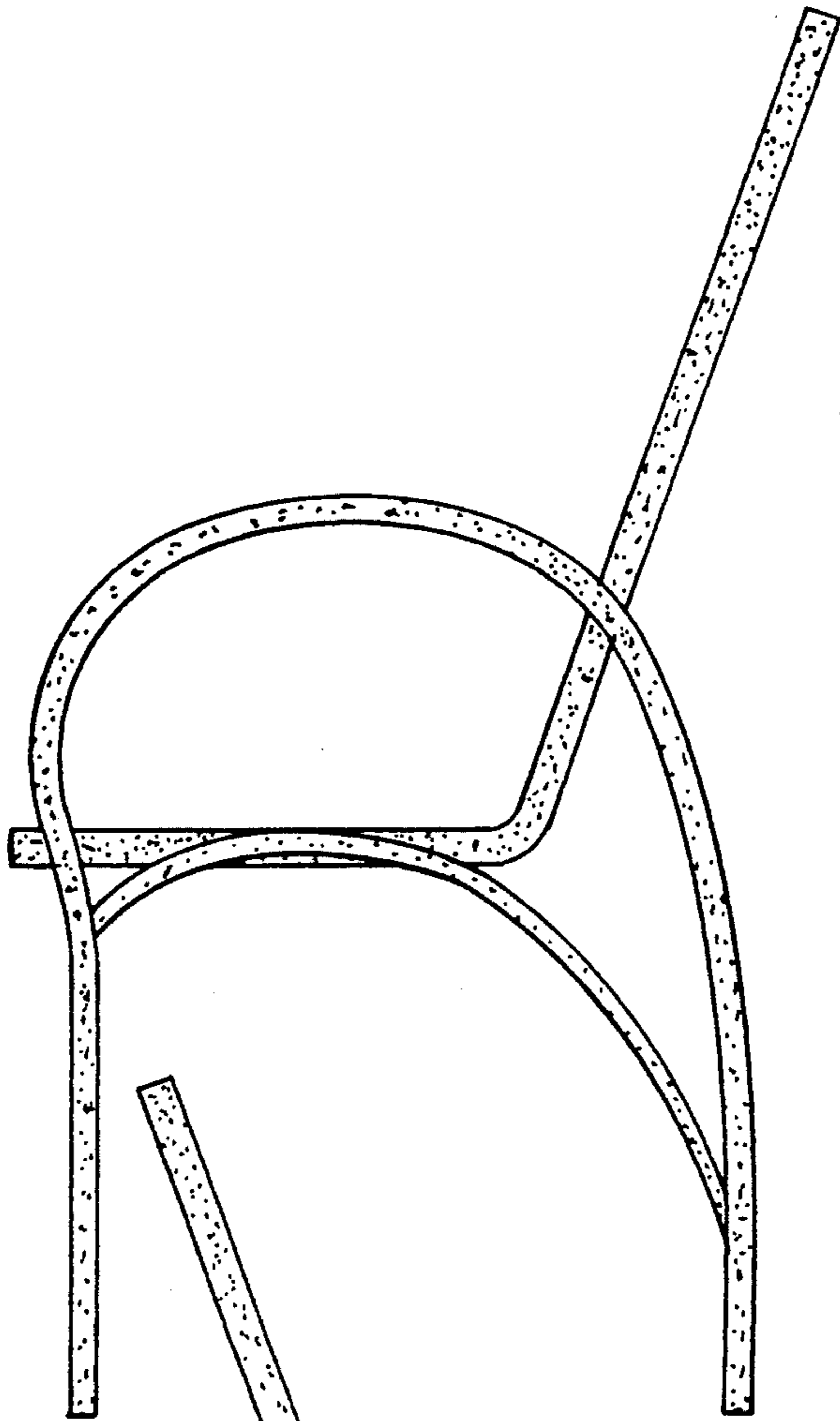

FIG. 4

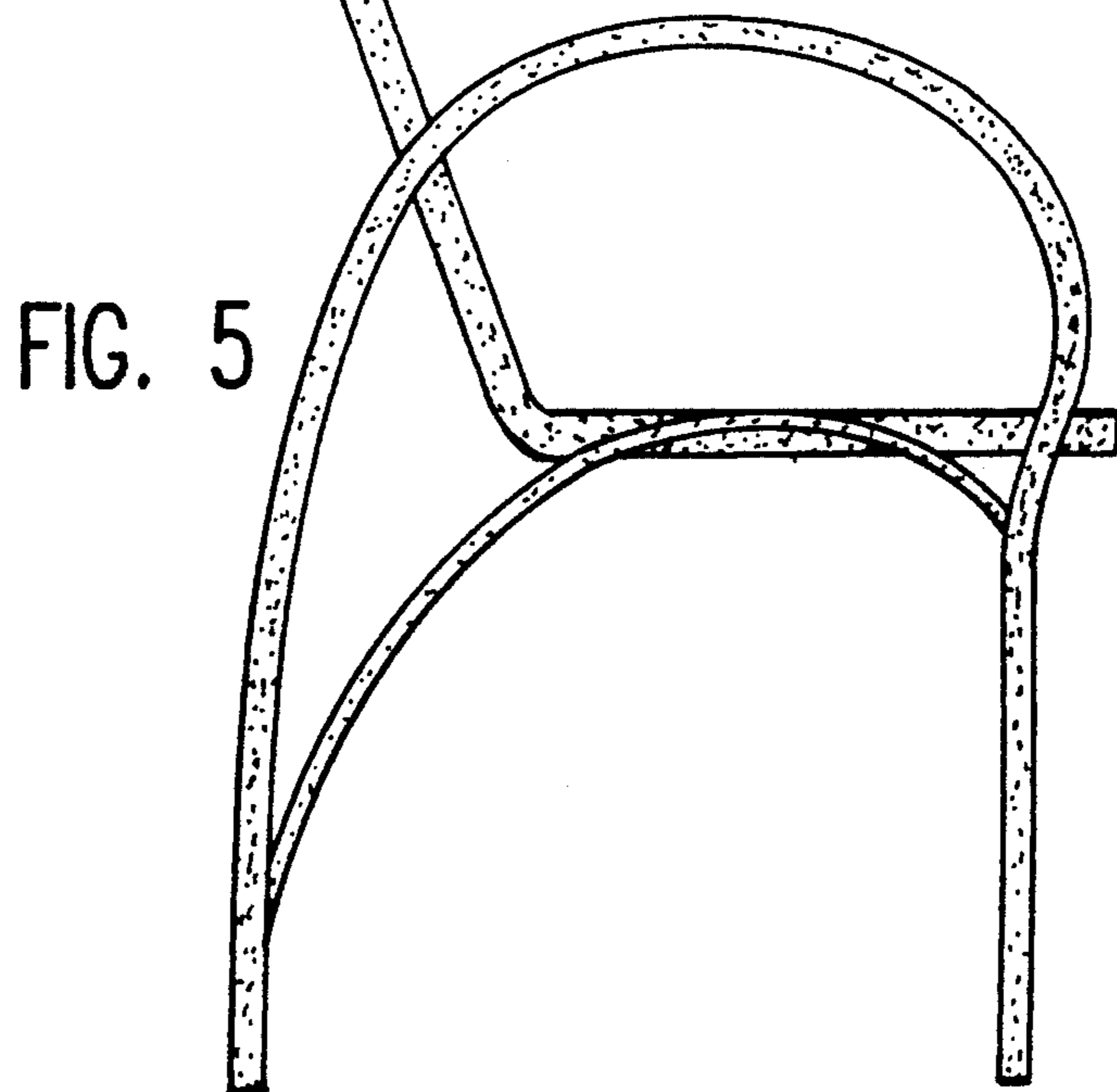

FIG. 5

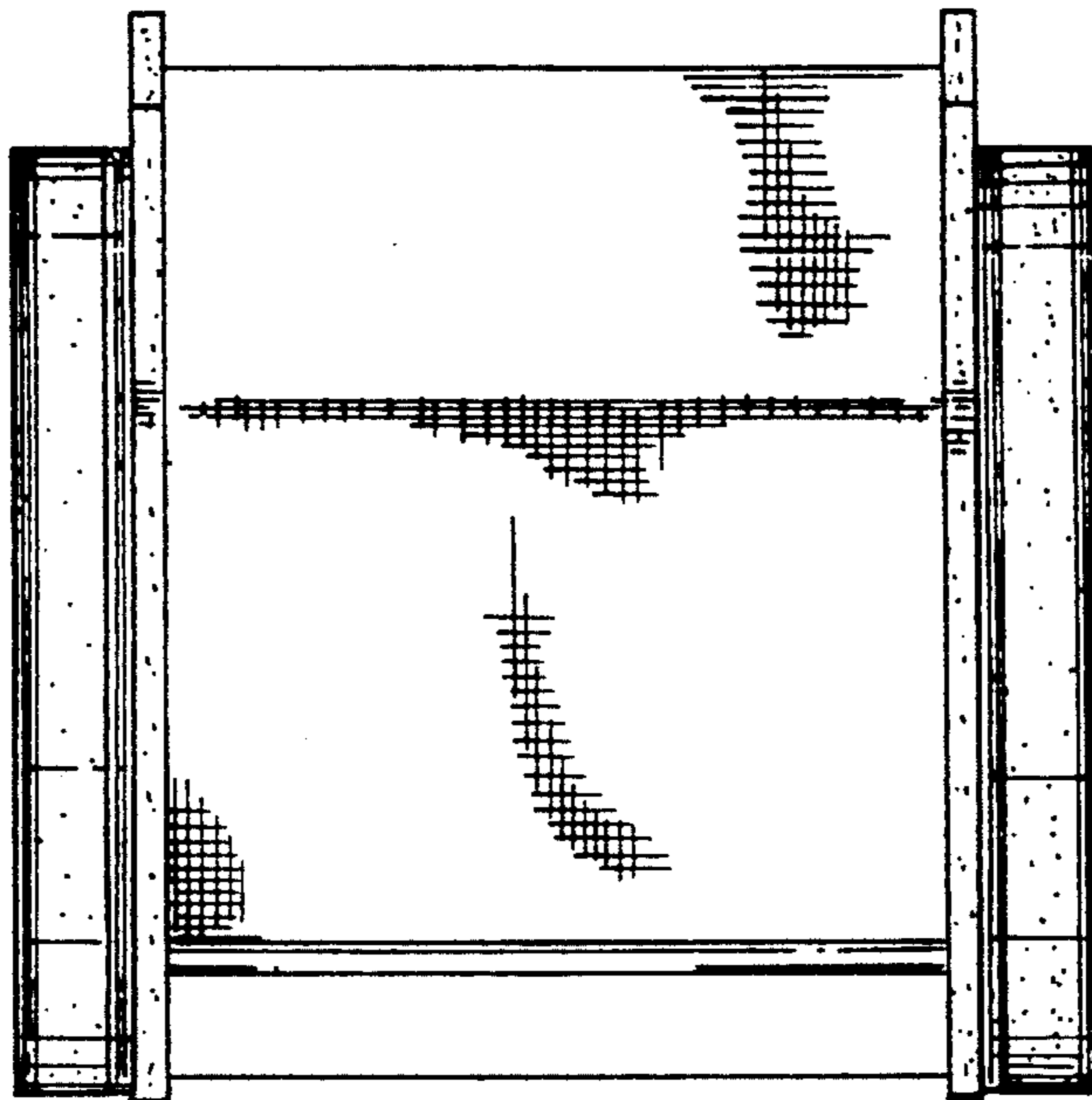

FIG. 6

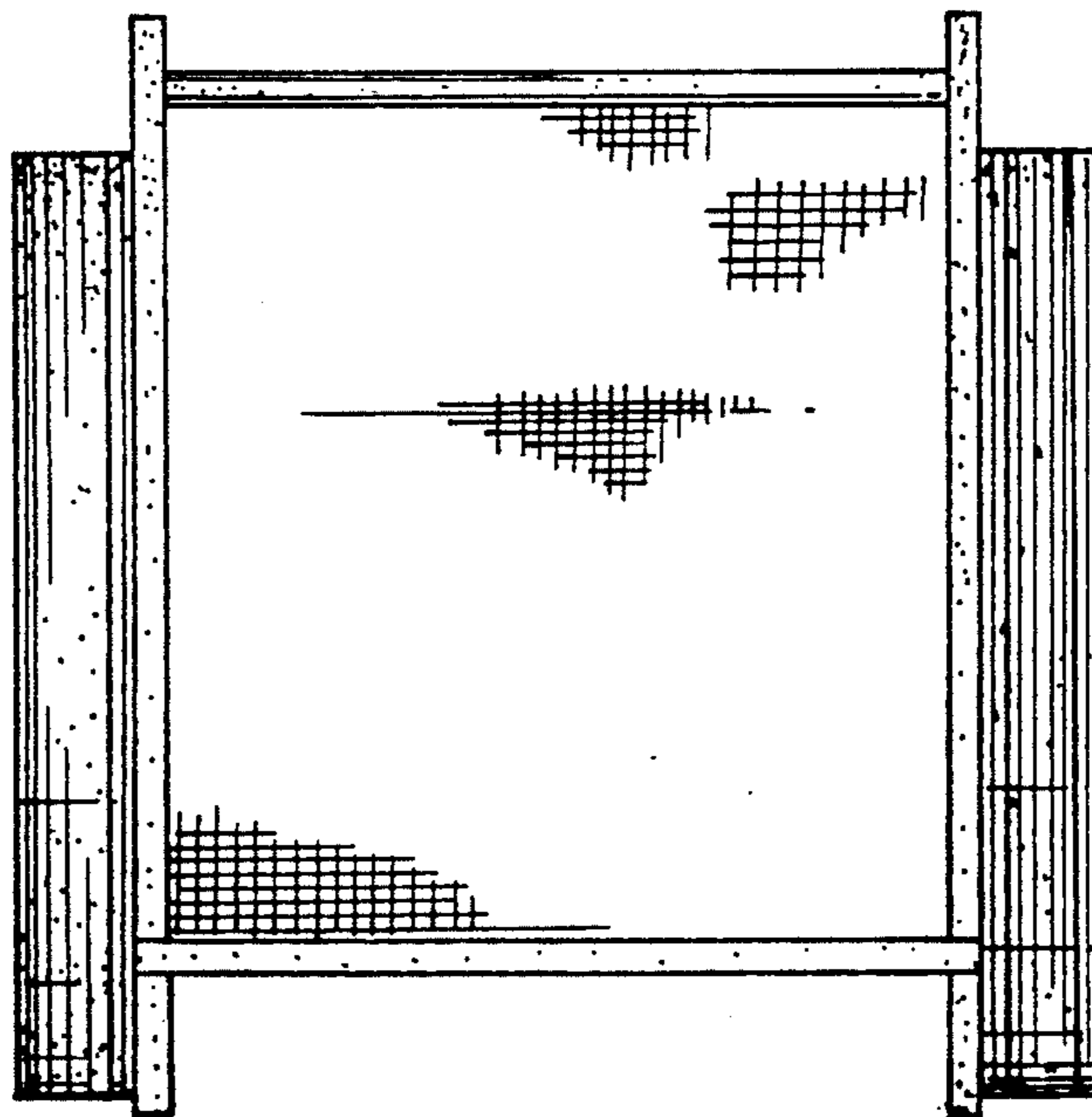

FIG. 7

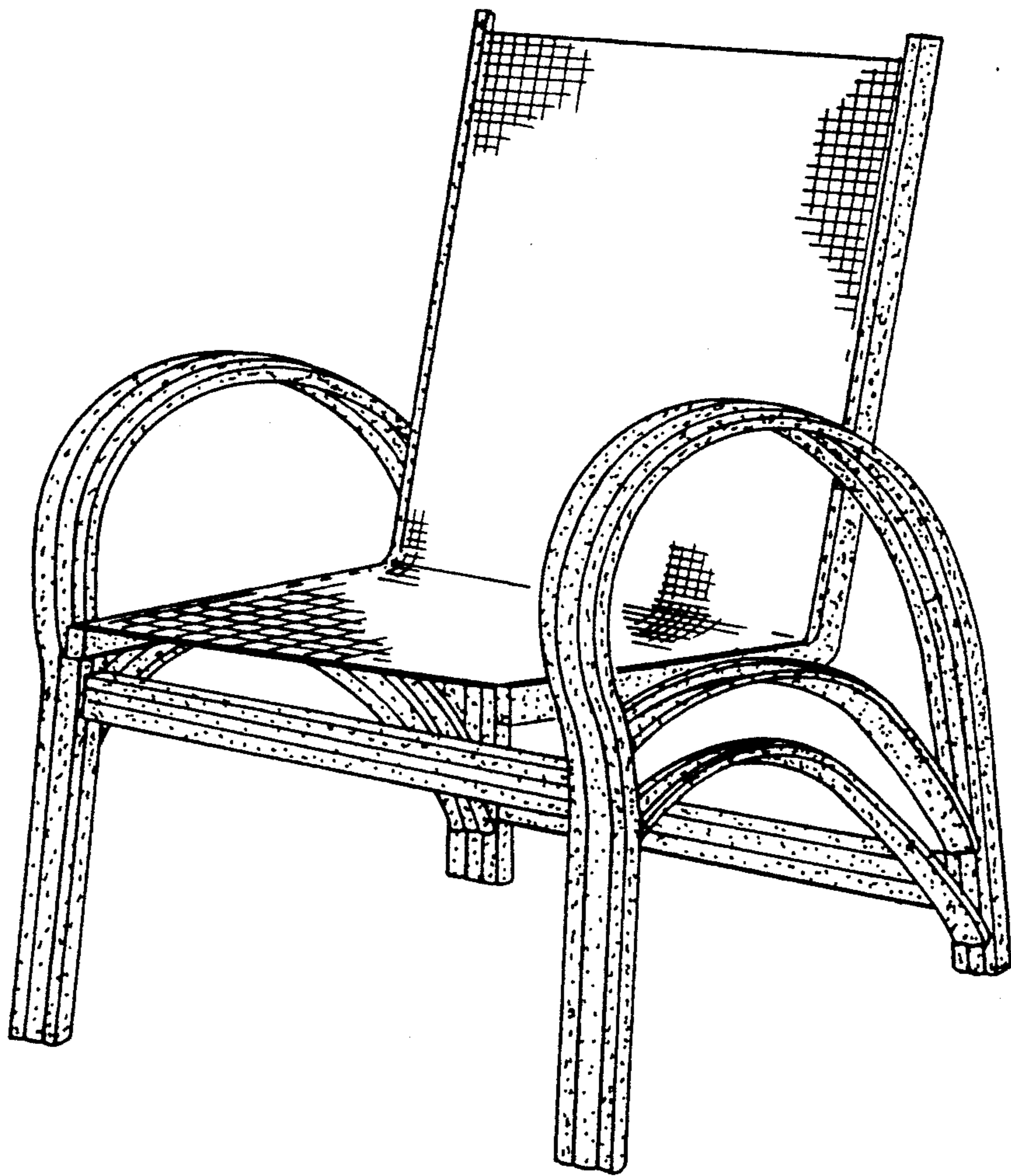

FIG. 8

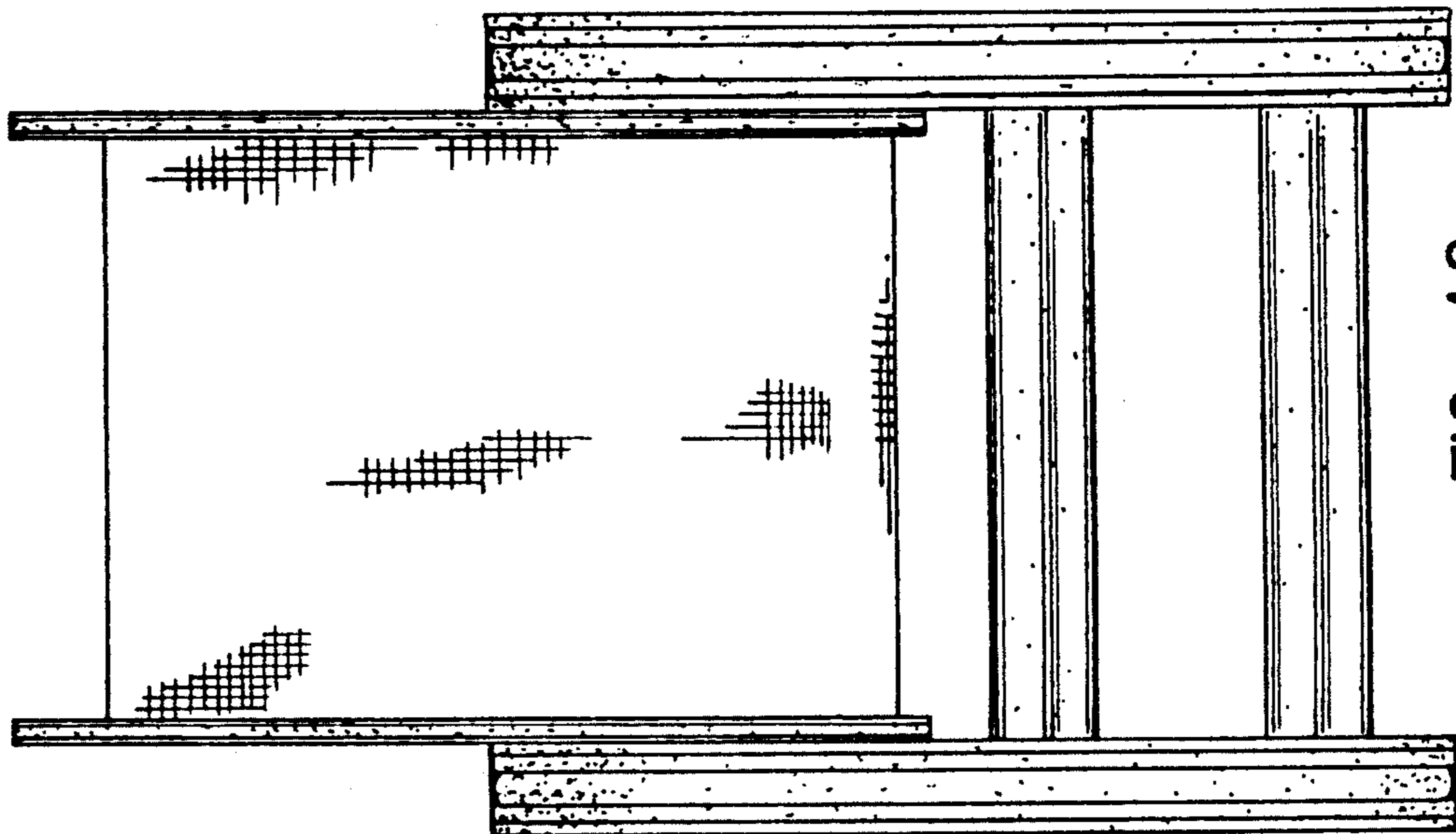

FIG. 10

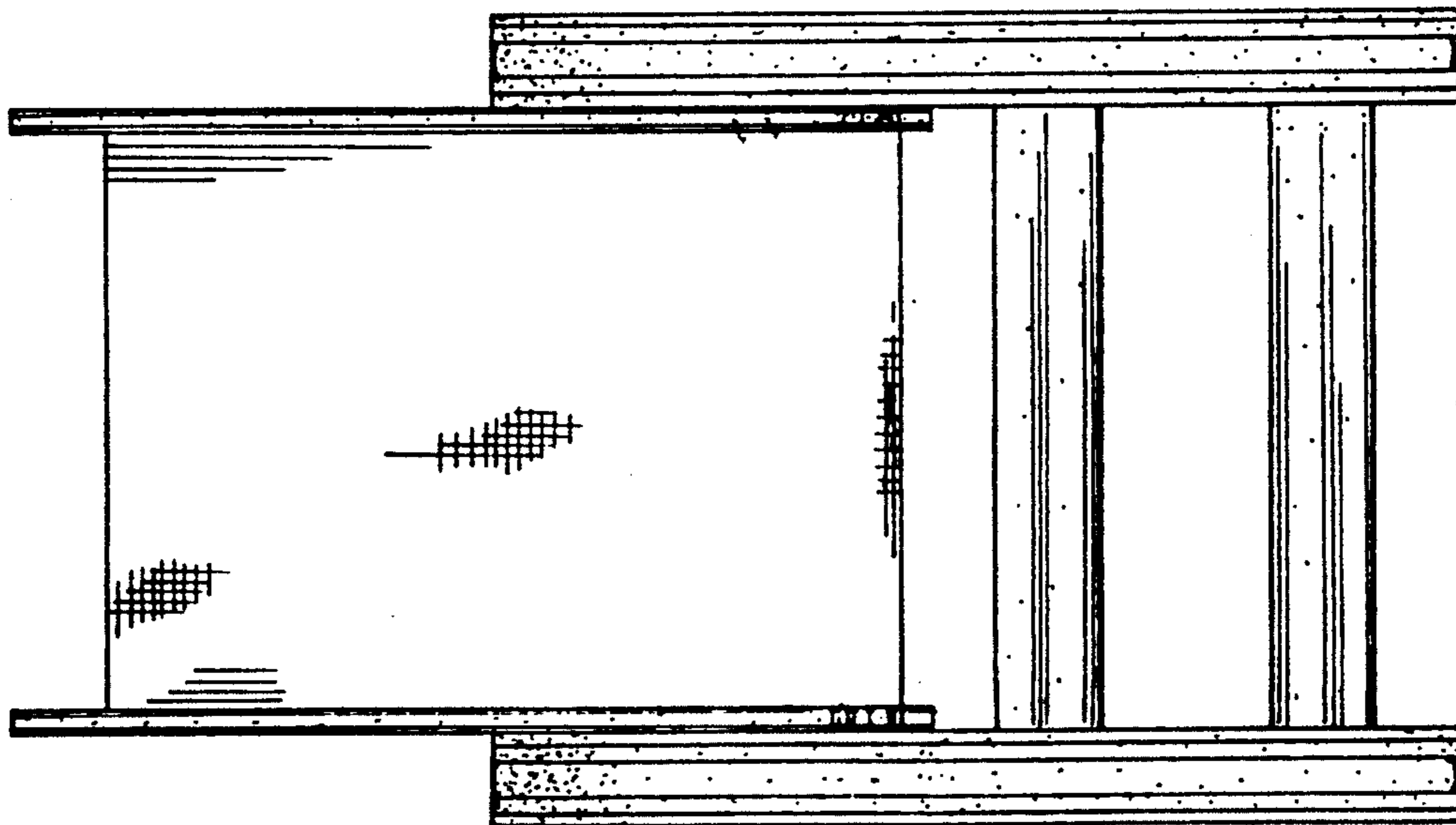

FIG. 9

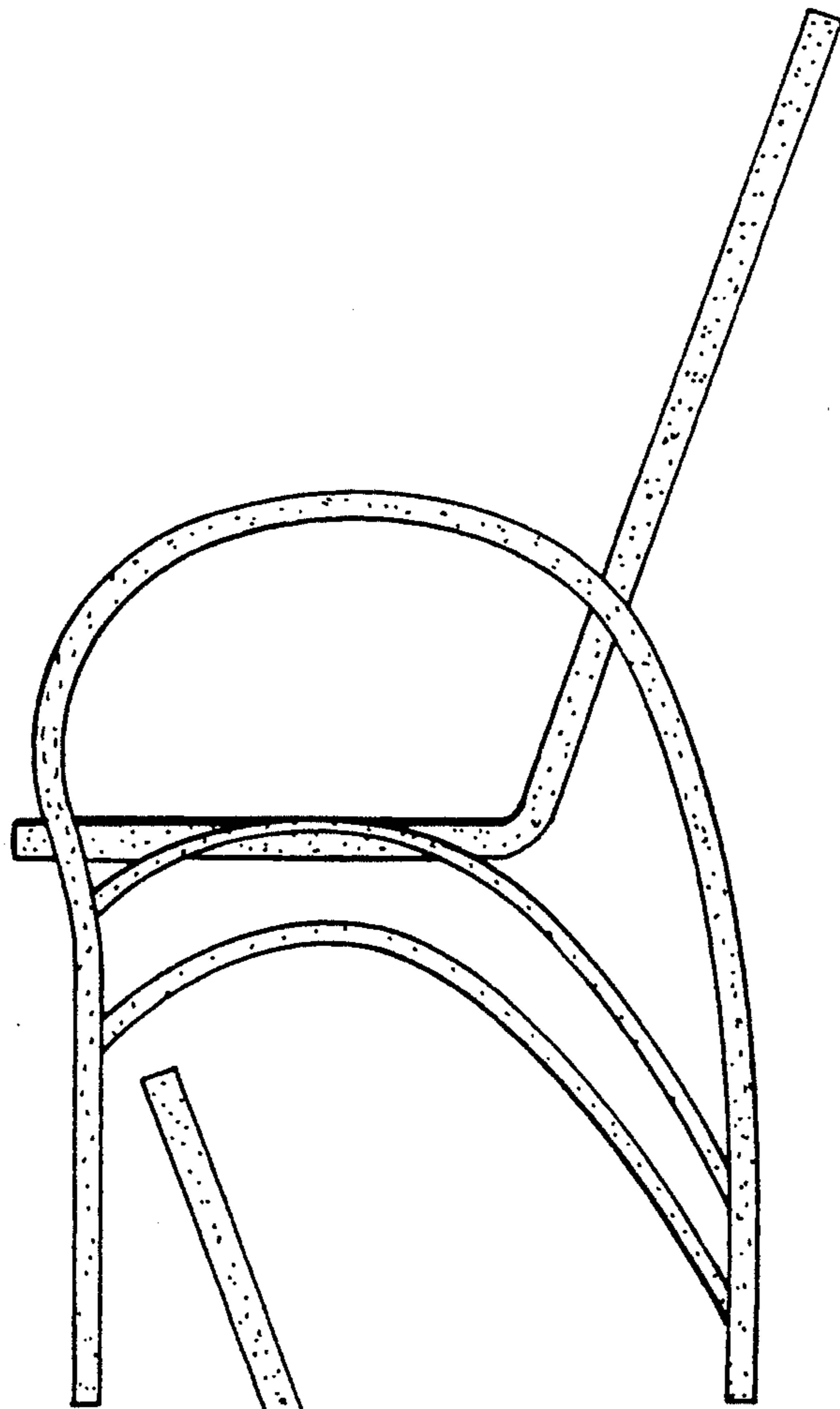
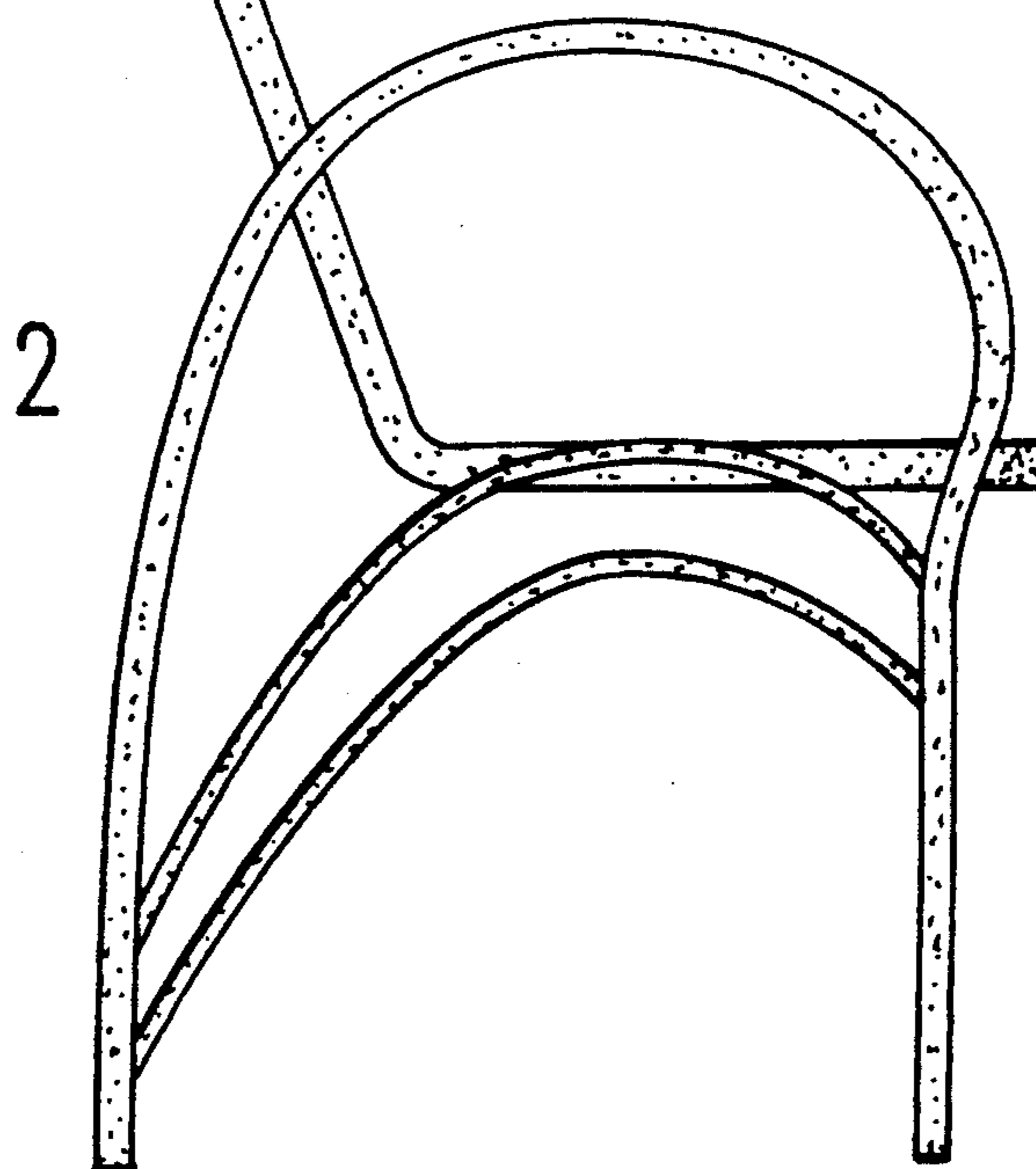

FIG. 11

FIG. 12





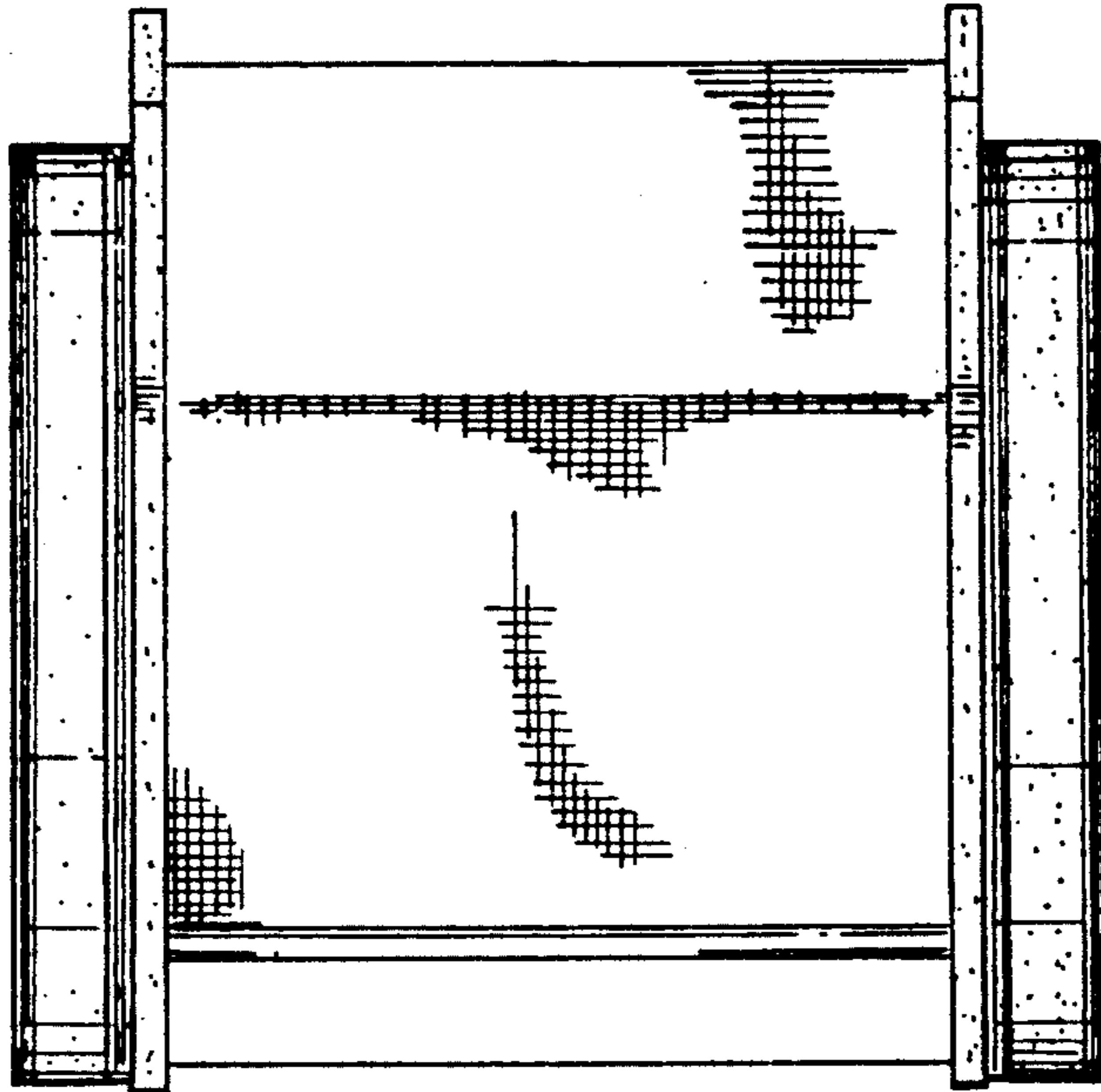

FIG. 13

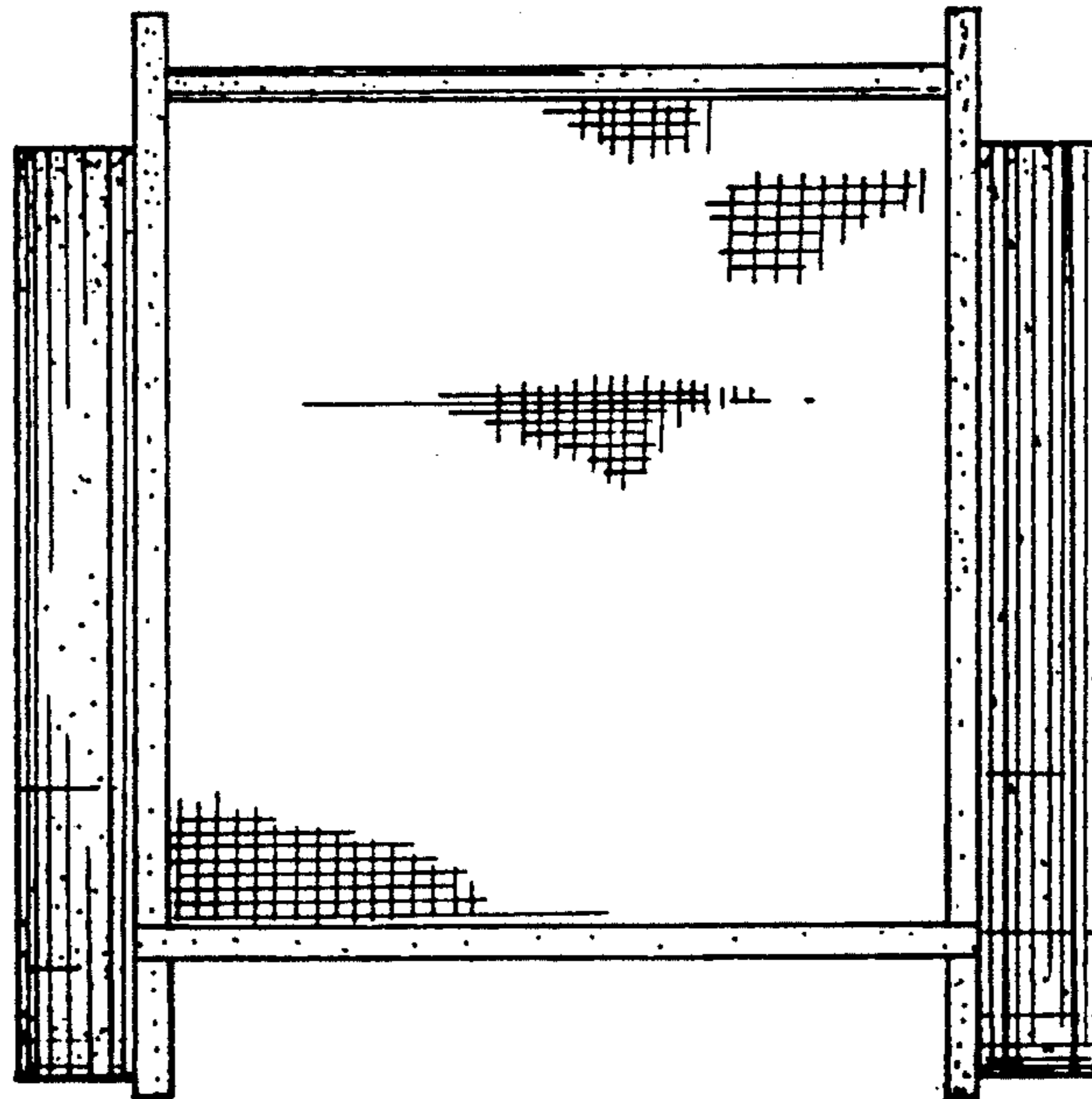

FIG. 14

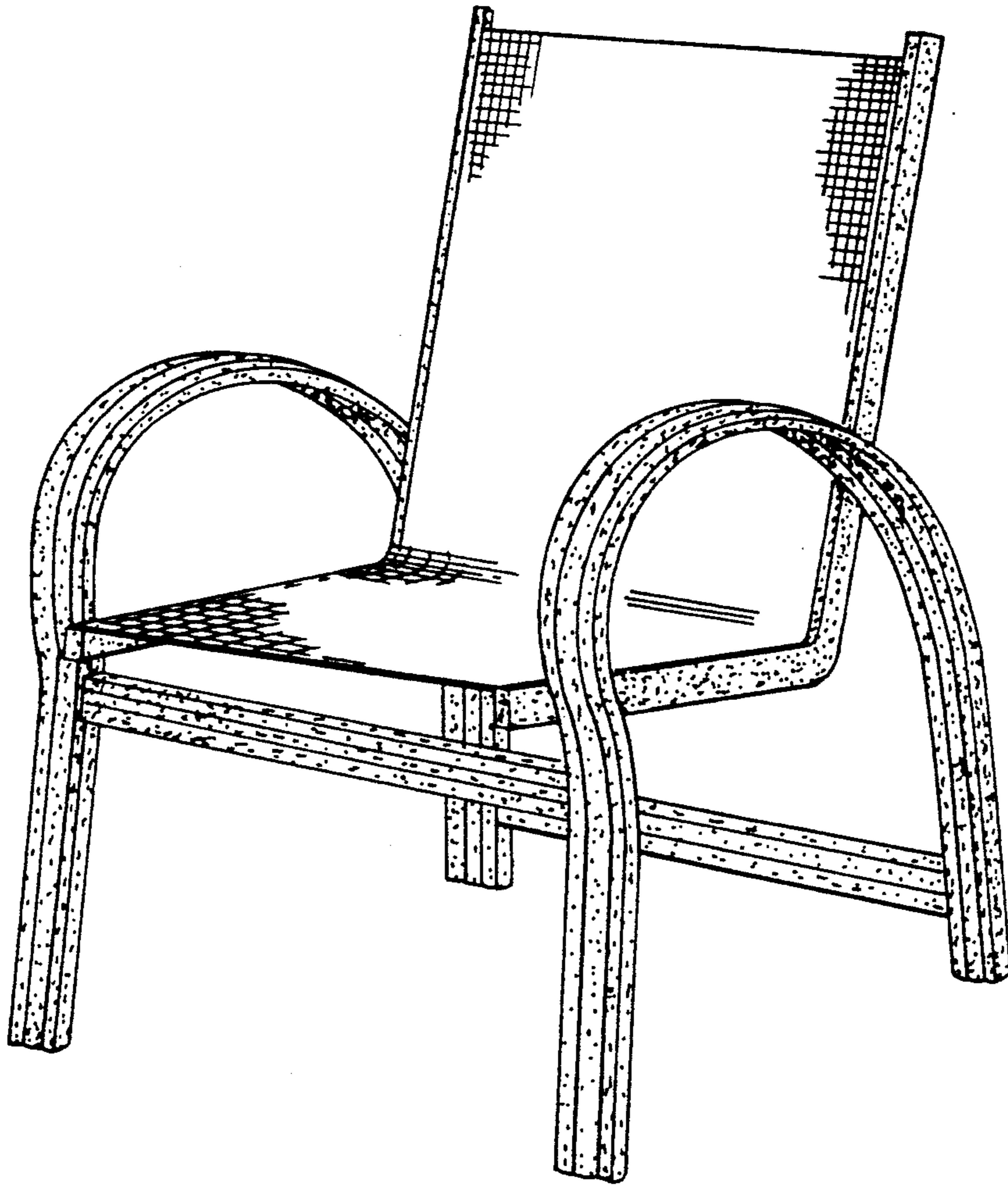

FIG. 15

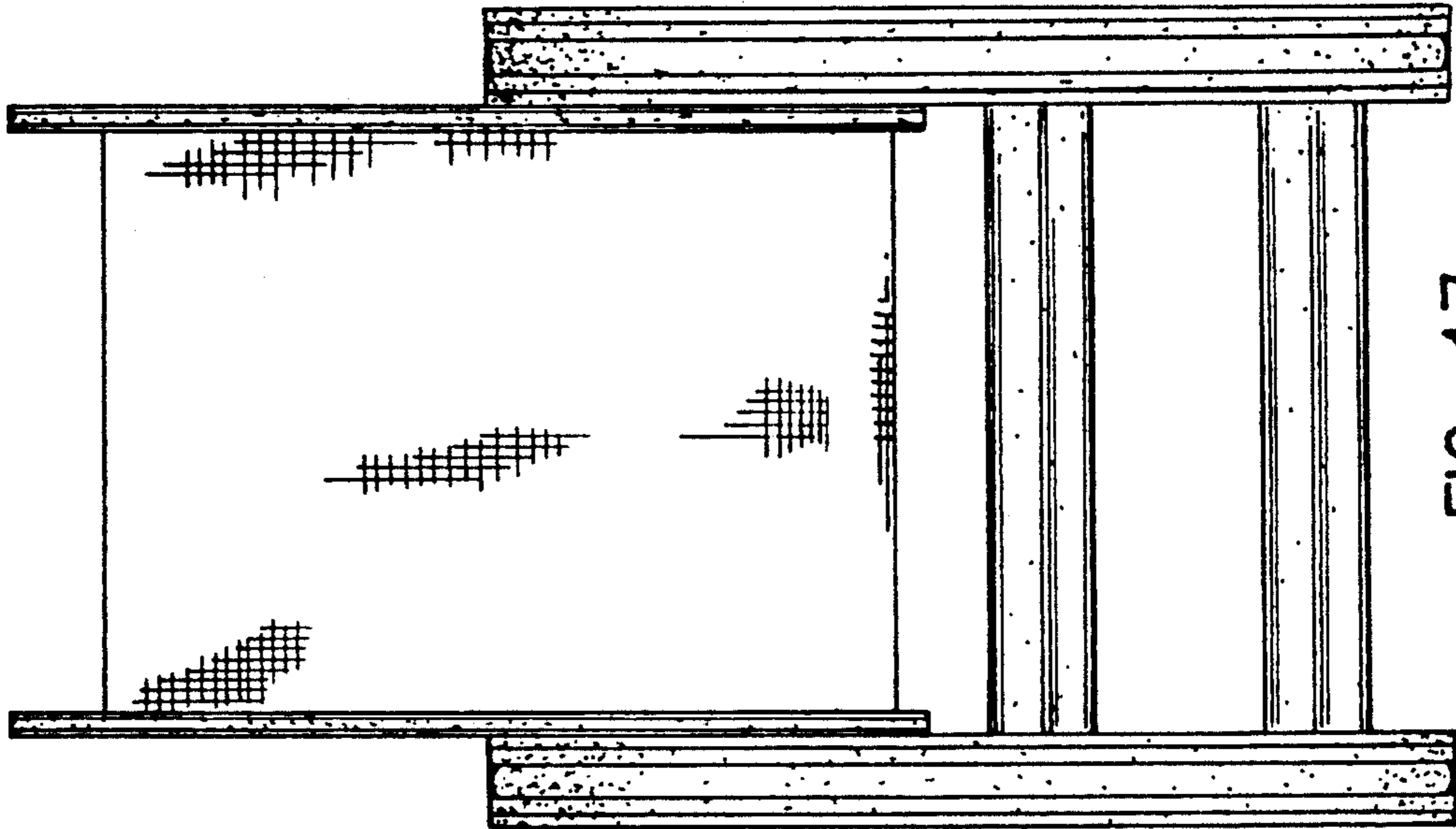

FIG. 17

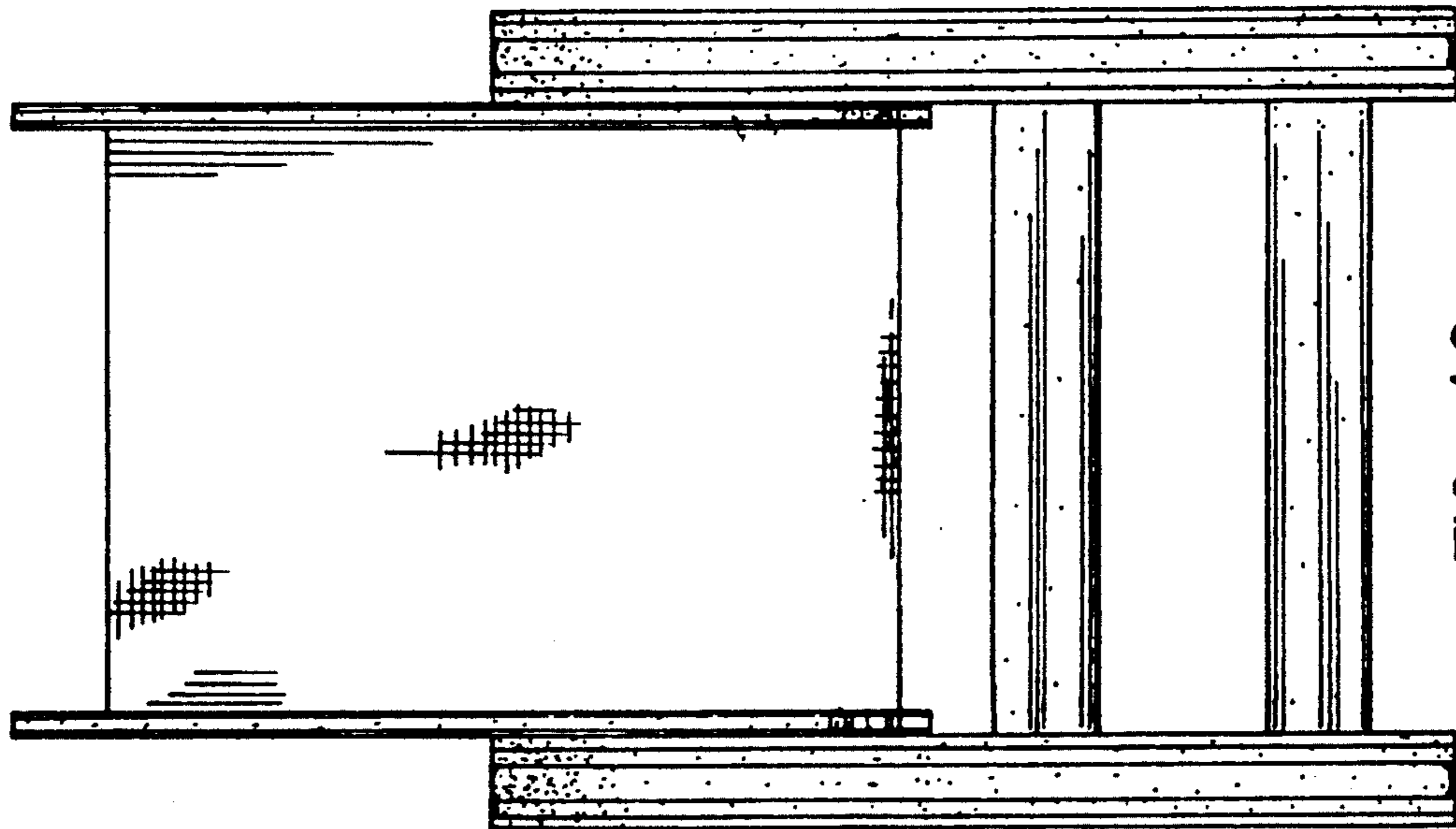

FIG. 16

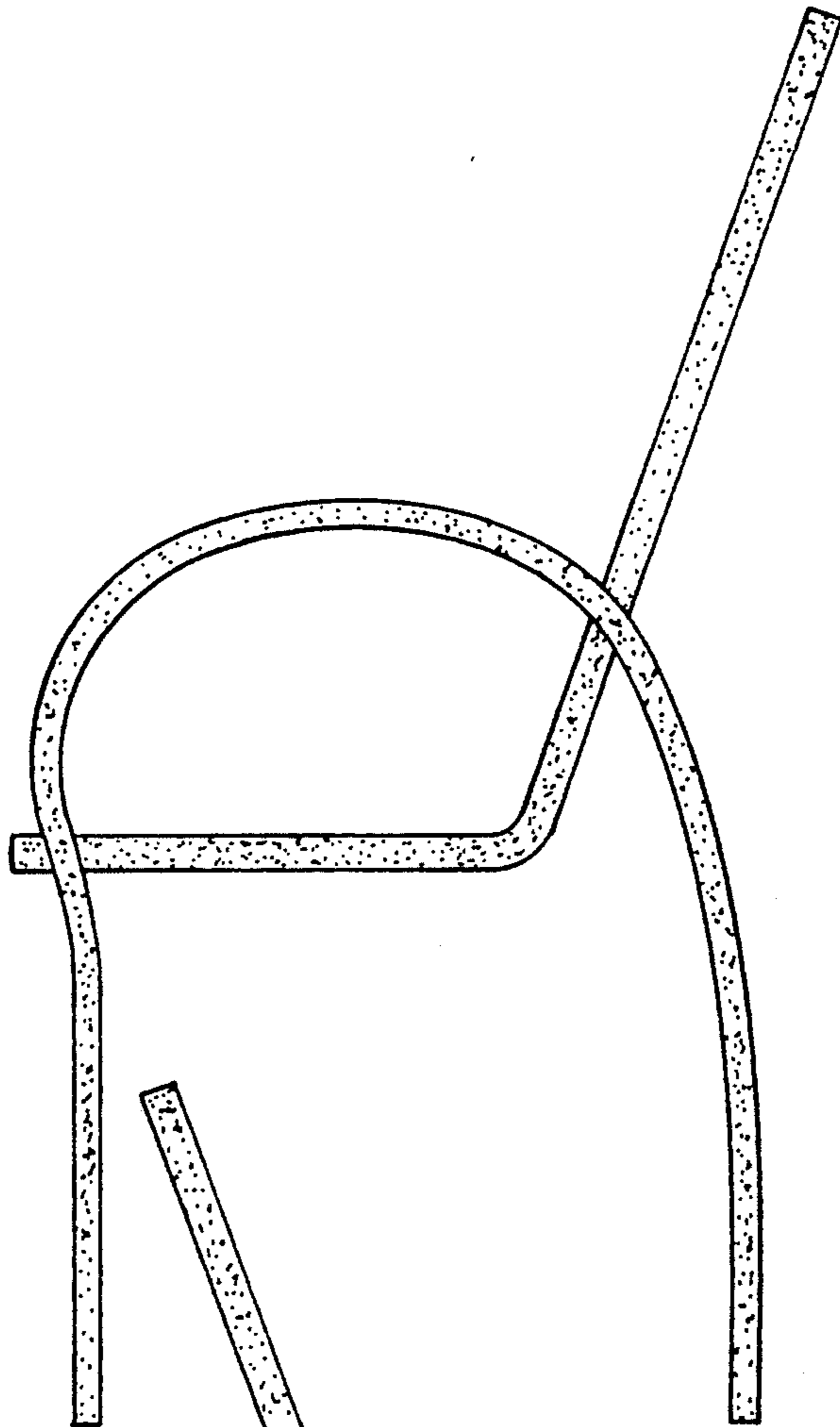

FIG. 18

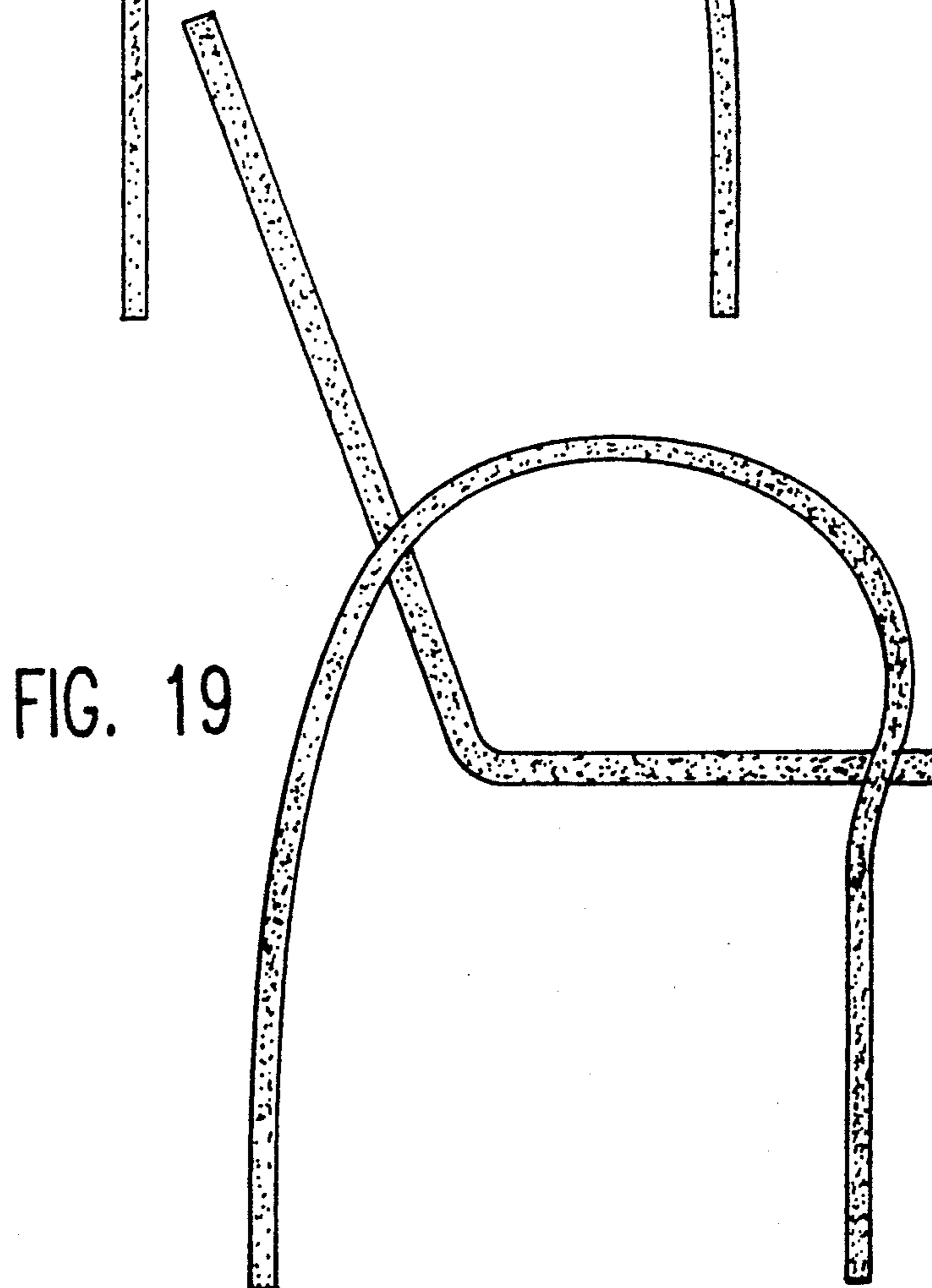

FIG. 19

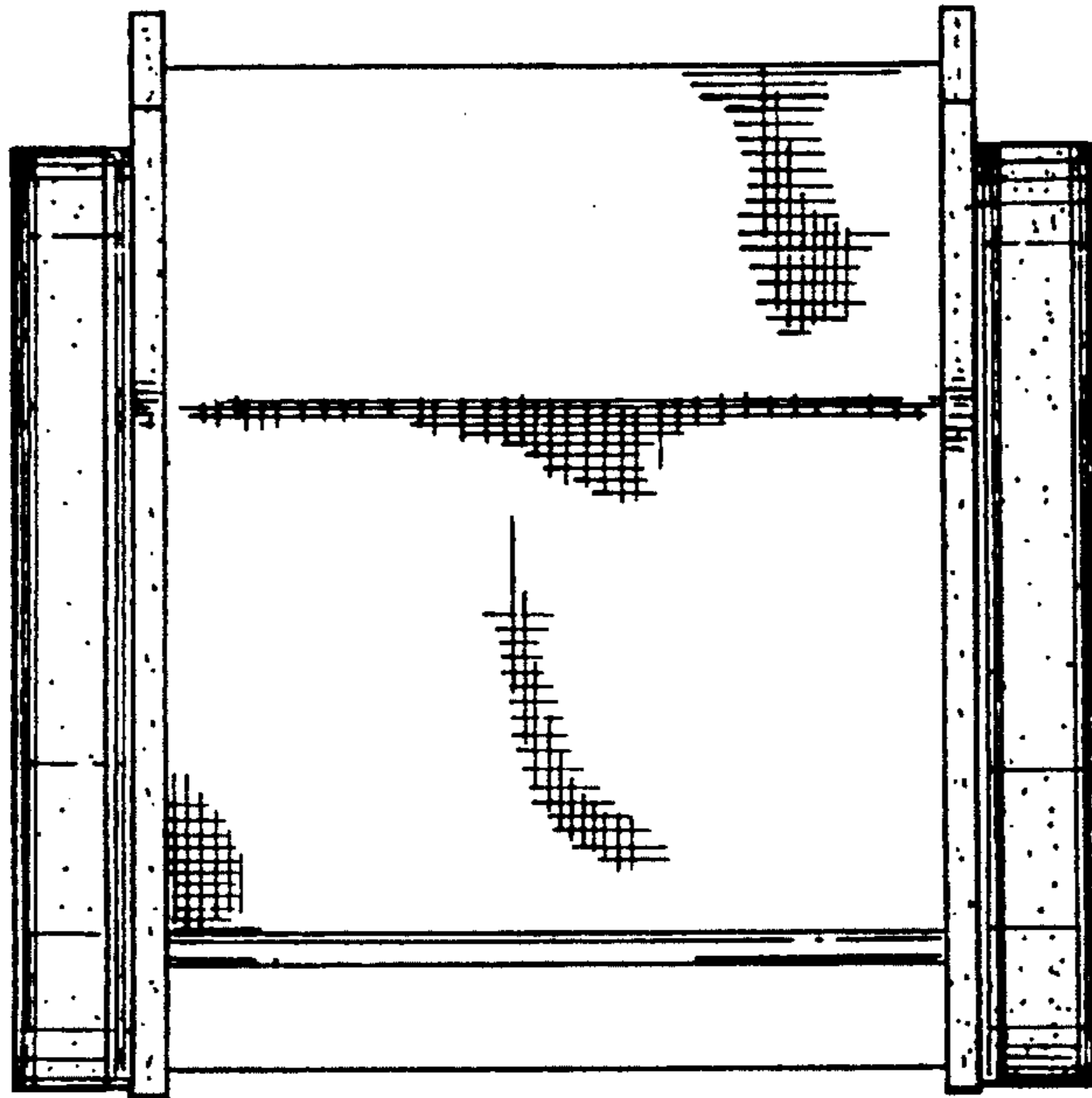

FIG. 20

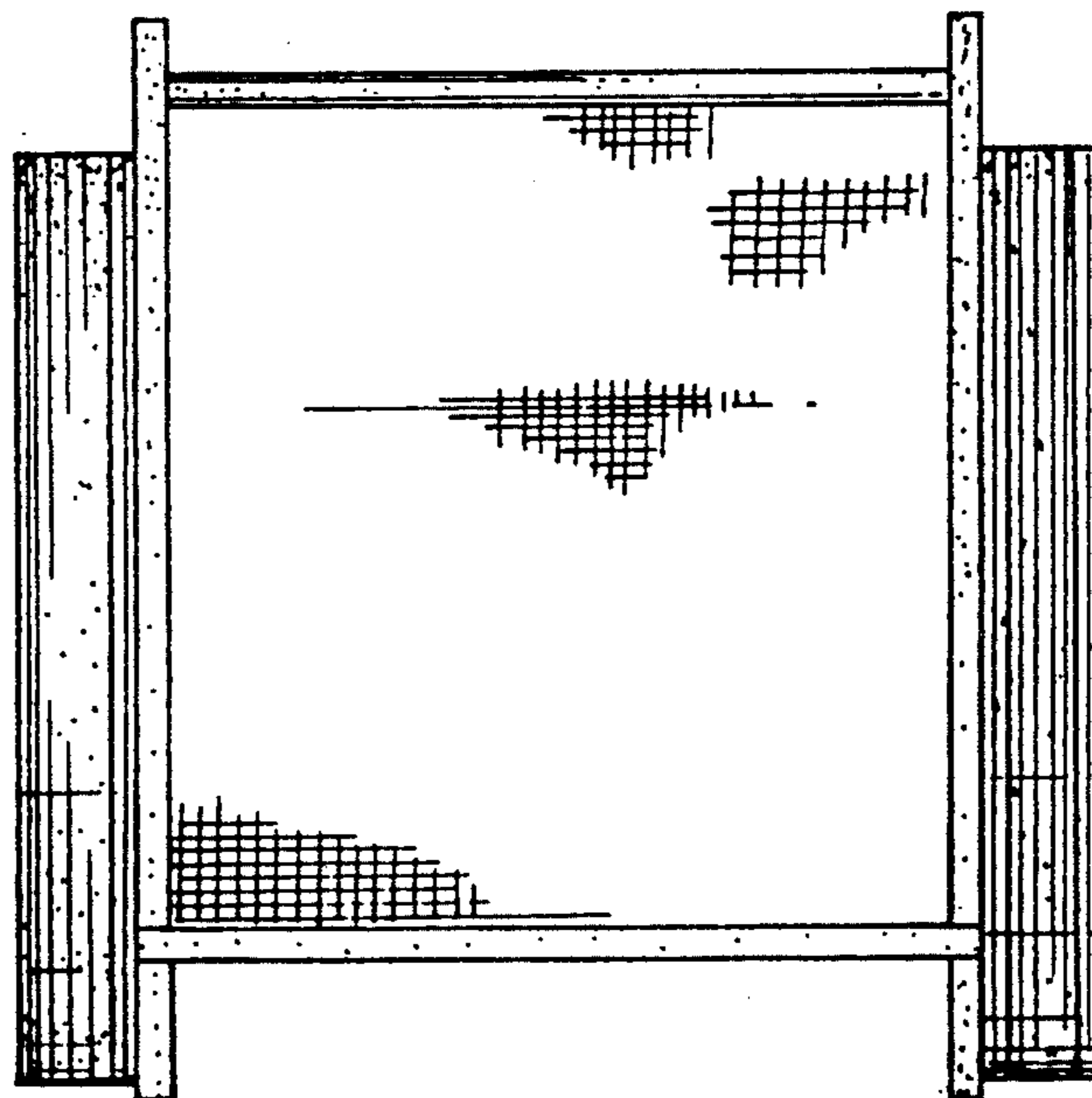

FIG. 21