



US00D336286S

United States Patent [19]

[11] Patent Number: **Des. 336,286**

Iino

[45] Date of Patent: **** Jun. 8, 1993**

[54] **ELECTRONIC COMPUTER**

[75] Inventor: **Masaaki Iino, Yokohama, Japan**

[73] Assignee: **Kabushiki Kaisha Toshiba, Kanagawa, Japan**

[**] Term: **14 Years**

[21] Appl. No.: **611,958**

[22] Filed: **Nov. 13, 1990**

[30] **Foreign Application Priority Data**

May 14, 1990 [JP] Japan 2-15730

[52] U.S. Cl. **D14/106**

[58] Field of Search **D14/100, 101, 106, 113, D14/115; D18/1, 7, 11, 12; 235/145 A, 145 R; 340/700, 706; 341/22, 23; 361/390, 394; 364/708, 709.04**

[56] **References Cited**

U.S. PATENT DOCUMENTS

D. 224,784	7/1972	Sucre et al.	D26/5
D. 243,250	2/1977	Hazama	D18/1
D. 254,005	1/1980	Zadock et al.	D14/43
D. 269,529	6/1983	Luen	D19/22
D. 275,102	8/1984	MacConnel	D14/106
D. 280,511	9/1985	Moggridge et al.	D14/106
D. 280,622	9/1985	Moggridge et al.	D14/100
D. 282,843	3/1986	Kurihara et al.	D14/100
D. 283,511	4/1986	Dunn	D14/106
D. 284,193	6/1986	Marshall	D14/101
D. 284,474	7/1986	Sawada	D14/100
D. 284,966	8/1986	Larkins	D14/100
D. 287,969	1/1987	Kusanagi	D14/106
D. 288,566	3/1987	Chin et al.	D14/106
D. 289,177	4/1987	Sawada	D18/7
D. 289,763	5/1987	Fujii et al.	D14/106
D. 290,256	6/1987	Sapper et al.	D14/106
D. 290,609	6/1987	Harlan et al.	D14/100
D. 290,845	7/1987	Yubisui et al.	D14/111
D. 291,442	8/1987	Kurihara	D14/106
D. 293,677	1/1988	Hara et al.	D14/106
D. 293,678	1/1988	Sawatani et al.	D14/106
D. 294,029	2/1988	Nishiyama et al.	D14/106
D. 294,831	3/1988	Hara et al.	D14/106
D. 295,176	4/1988	Nishimoto et al.	D14/106
D. 295,519	3/1988	Kimble	D14/106
D. 298,623	11/1988	Yubisui et al.	D14/100
D. 299,031	12/1988	Sugano	D14/106

D. 303,523	9/1989	Shiozawa et al.	D14/106
D. 303,790	10/1989	Kato et al.	D14/106
D. 304,930	12/1989	Hongo et al.	D14/100
D. 305,883	2/1990	Burton	D14/106
D. 306,285	2/1990	Yu	D14/106
D. 307,581	5/1990	Ooshima	D14/106
D. 308,050	5/1990	Sugano et al.	D14/106
D. 308,516	6/1990	Takach, Jr. et al.	D14/106
D. 308,860	6/1990	Tsukada et al.	D14/106
D. 308,861	6/1990	Tsukada et al.	D14/106
D. 309,603	7/1990	Mizusugi et al.	D14/106
D. 309,749	8/1990	Ido	D18/7
D. 310,353	9/1990	Sugano et al.	D14/106
D. 310,828	9/1990	Grundstrom et al.	D14/106
D. 311,527	10/1990	Fujii et al.	D14/106
D. 311,528	10/1990	Sugano et al.	D14/106
D. 311,906	11/1990	Iino	D14/106
D. 312,822	12/1990	Watabe et al.	D14/106
D. 313,978	1/1991	Miyakuni	D14/106
D. 314,558	2/1991	Iino	D14/106
D. 316,706	5/1991	Imamura et al.	D14/106
D. 317,444	6/1991	Mizusugi et al.	D14/106
D. 319,819	9/1991	Kawaguchi	D14/106
D. 321,176	10/1991	Ma	D14/106
D. 322,246	12/1991	Izaki	D14/100
D. 323,156	1/1992	Nishida	D14/101
D. 324,035	2/1992	Izaki	D14/100
D. 324,036	2/1992	Wakasa	D14/101
D. 324,674	3/1992	Iino	D14/106
4,703,160	10/1987	Narishima et al.	235/1 D

FOREIGN PATENT DOCUMENTS

100708	6/1988	China	.
100709	6/1988	China	.
101093	7/1988	China	.
800660	10/1988	Fed. Rep. of Germany	.
M8803410	12/1989	Fed. Rep. of Germany	.
M8803411	12/1989	Fed. Rep. of Germany	.
M8908516	7/1990	Fed. Rep. of Germany	.
47-14961	5/1972	Japan	.
499866	4/1979	Japan	.
639216	11/1984	Japan	.
650470	5/1985	Japan	.
664175	10/1985	Japan	.
684172	8/1986	Japan	.
685000	8/1986	Japan	.
685063	8/1986	Japan	.
685121	8/1986	Japan	.
685542	8/1986	Japan	.
686374	9/1986	Japan	.

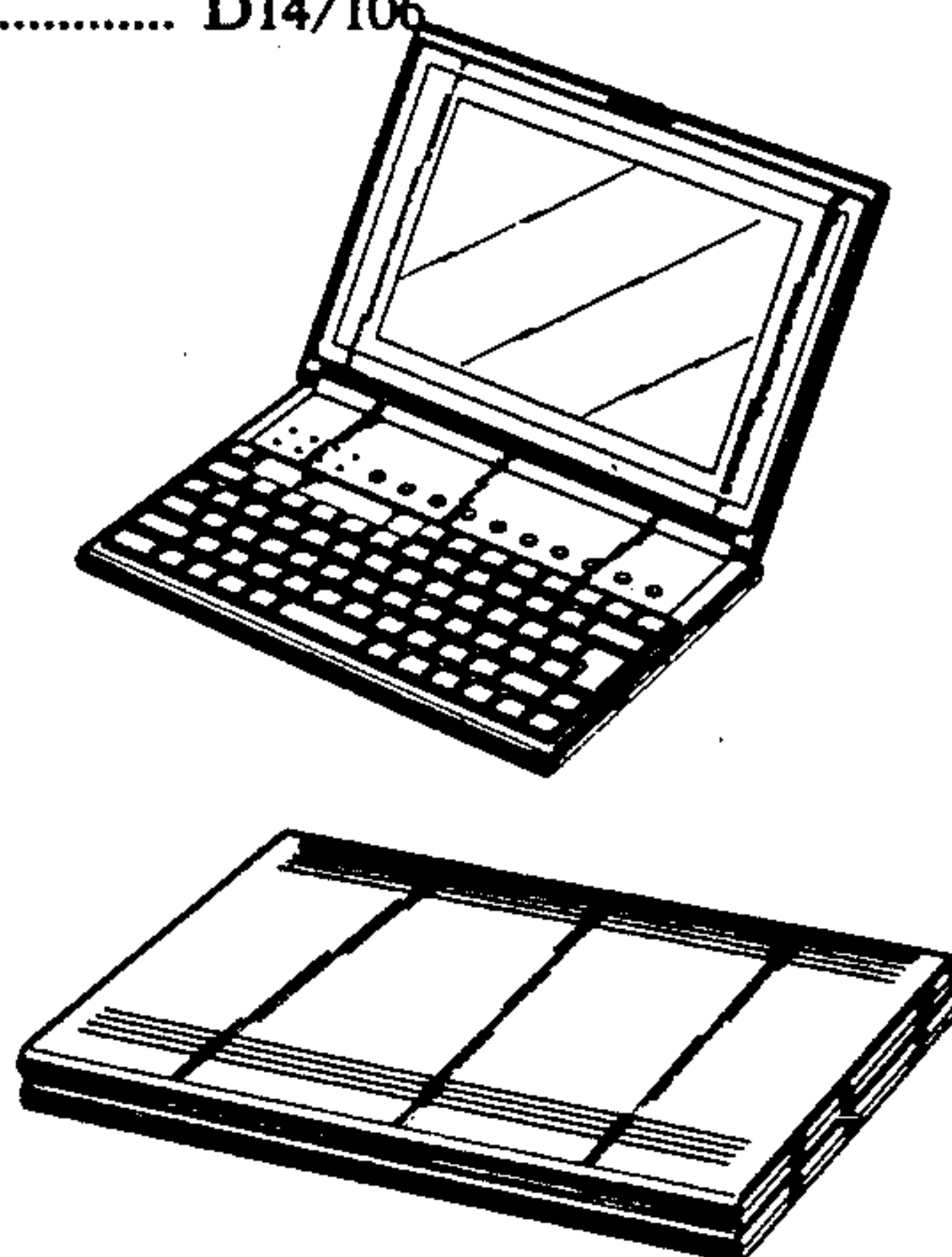

686381	9/1986	Japan .	Hewlett Packard Advertisement Jun. 5, 1984.
686386	9/1986	Japan .	Epson HC-88 Jul. 1, 1984.
686654	9/1986	Japan .	Hitachi Advertisement Sep. 4, 1984.
686658	9/1986	Japan .	Hewlett Packard Advertisement Sep. 12, 1984.
686706	9/1986	Japan .	Sharp PC-5000 Brochure Sep. 26, 1984.
695931	12/1986	Japan .	Data General One Advertisement Sep. 28, 1984.
696188	1/1987	Japan .	Apple Computer Apple IIC Oct. 15, 1984.
697328	1/1987	Japan .	TI Software Journal, Pro-Lite TM Nov. 14, 1984.
763838	6/1988	Japan .	IS-11c Advertisement Nov. 14, 1984.
747990	11/1988	Japan .	Dulmont Magnum Article in Portable Computer Nov. 1984.
747991	11/1988	Japan .	IBM Advertisement Dec. 6, 1984.
748513	11/1988	Japan .	Tandy 200 1985.
749802	11/1988	Japan .	General Corp. 4400 Jan. 14, 1985.
746985(2)	4/1989	Japan .	Aval TM Advertisement Feb. 11, 1985.
746985(1)	4/1989	Japan .	Picture #J60007802 Feb. 26, 1985.
761927	5/1989	Japan .	Aval TM20 Mar. 8, 1985.
763840	6/1989	Japan .	Tandy 200 Mar. 16, 1985.
763855	6/1989	Japan .	NEC Starlet PC-8401A Brochure Mar. 29, 1985.
761927(1)	2/1990	Japan .	C & D News Mar. 29, 1985.
761927(2)	5/1990	Japan .	Hewlett-Packard HP110 Apr. 1985.
761927(3)	5/1990	Japan .	Fujitsu FM 16 Apr. 17, 1985.
761927(4)	6/1990	Japan .	Halkan LA-22, LA-30 Apr. 21, 1989.
67297	2/1987	Rep. of Korea .	NEC PC-9801 LX5C Brochure Aug. 23, 1988.
85031	10/1988	Rep. of Korea .	Sharp AX-286L Sep. 29, 1988.
85032	10/1988	Rep. of Korea .	Newspaper "The Nihon Kogyo Shinbun" dated Feb. 6, 1990 re Mr. Mytool Magus.
92859	7/1989	Rep. of Korea .	Catalog "Mr. Mytool Magus"-Ricoh.
92863	7/1989	Rep. of Korea .	Catalog "NERO/DXS"-Victoreen.
94470	9/1989	Rep. of Korea .	Fujitsu FM16 TL Brochure May 22, 1985.
97355	12/1989	Rep. of Korea .	Data General One Brochure May 23, 1985.
100917	4/1990	Rep. of Korea .	Toshiba T 1100 Plus Jul. 22, 1985.
852546	1/1987	Sweden .	Minato Electronics MODS-5000 Aug. 22, 1985.
OTHER PUBLICATIONS			GridCase Brochure Sep. 24, 1985.
NEC PC-98LT Advertisement Oct. 23, 1986.			FBS Advertisement Oct. 30, 1985.
Yaskawa P-t50 Advertisement Nov. 12, 1986.			NEC N6919 Model 80/80H Nov. 11, 1985.
Yaskawa Memocon TM -SC GL20 Advertisement Mar. 27, 1987.			IBM Advertisement Nov. 28, 1985.
TI Advertisement in Telephony Apr. 1, 1987.			Apple Computer IIC Dec. 1985.
Data General One Model 2J Brochure May 20, 1987.			Hewlett-Packard Portable Plus Dec. 1985.
Hitachi B16LX Brochure Aug. 31, 1987.			FLM-700 Jan. 31, 1986.
Sharp Advertisement May 19, 1976.			Fujitsu FM 16 May 21, 1986.
Fanuc System P-Model Jul. 27, 1983.			PC-816F Advertisement May 27, 1986.
Moebel Interior Design Jan. 5, 1984.			Zenith Data Systems Newsdate Newsletter Jun. 7, 1986.
The Office 98-6 Jan. 31, 1984.			Tandy 600 Advertisement Jul. 25, 1986.
Demus 645 Feb. 22, 1984.			Richo JP70D Brochure Sep. 29, 1986.
MRD Advertisement Mar. 29, 1984.			
Gavilan Mobile Computer Brochure Apr. 19, 1984.			
Picture #J9016870 May 8, 1984.			
Hewlett Packard Advertisement May 18, 1984.			

Data General One Brochure Oct. 3, 1986.
 Article re IBM Portable Personal Computer Oct. 15, 1986.
 Ricoh Brochure Sep. 17, 1987.
 Sony Produce 100 Brochure Sep. 18, 1987.
 Panasonic FW-U1EX Advertisement Oct. 2, 1987.
 Nihon IBM 55 Model 5535 Oct. 19, 1987.
 NEC Minitel 5 Advertisement Oct. 29, 1987.
 Rein Laptop 300 SLC Advertisement Oct. 29, 1987.
 IBM 5540/5535 Brochure Nov. 4, 1987.
 NEC PC-9800 Advertisement Nov. 27, 1987.
 Panasonic U1EX Advertisement Dec. 8, 1987.
 Schneider Multivision 300 SLC Catalog 1988.
 Panasonic U1Pro Jan. 4, 1988.
 Diagnostic Products Review Jan. 2, 1988.
 Toshiba E & E News Feb. 26, 1988.
 Seiko-Epson PC-286L Mar. 2, 1988.
 Toshiba JW90FII Rupo Brochure Mar. 3, 1988.
 Hitachi B16LX Brochure Apr. 5, 1988.
 Sony Produce PJ-100EX Brochure Apr. 5, 1988.
 WS Japanese Advertisement Apr. 27, 1988.
 NEC Multispeed Spring 1988.
 Samsung S5200 May 10, 1988.
 Datavue Snap 1+1 May 10, 1988.
 Portable Computer Review, p. 32 May 10, 1988.
 GridCase 1530 Advertisement May 10, 1988.
 NEC MultiSpeed EL Model 2 Brochure May 10, 1988.
 Sharp PC-5000 Brochure May 12, 1988.
 Japanese Advertisement May 12, 1988.
 Sanyo ES 100 May 13, 1988.
 NEC PC-9801 LV 21 Brochure May 13, 1988.
 Sharp WV-500 May 19, 1988.
 Panafacom C-250 LT Brochure May 19, 1988.
 Sony Produce 100EX Advertisement May 19, 1988.
 Panasonic Panacom 6000 LT Brochure Jun. 7, 1988.
 NEC Mini 5 Carryword Brochure Jun. 27, 1988.
 Ricoh JP90LX Brochure Jun. 28, 1988.
 NEC Mini 5 HL Brochure Jun. 30, 1988.
 NEC PC-98 LT Brochure Jul. 14, 1988.
 NEC PC-9801 LX5C Aug. 23, 1988.
 Kyosera 386AX Sep. 1988.
 Sharp AX 286L Sep. 29, 1988.
 NEC PC-9801 Oct. 26, 1988.
 Sanyo MBC 17LTJH Oct. 1988.

Toshiba T 1600 Nov. 1988.
 Sanyo MBC 17LTJH Nov. 28, 1988.
 Oki "IF 386 AK" Dec. 9, 1988.
 Kyosera 386-SX Laptop AX Jan. 10, 1989.
 Seiko-Epson PC-286LS Feb. 16, 1989.
 Chaplet Halikan LA-22 Apr. 21, 1989.
 NEC PC-9801 LV21 May 13, 1989.
 Fujitsu G-150LT May 19, 1989.
 Epson HC-88, HC80 Brochure undated.
 Epson PX-8 Personal Computer Brochure undated.
 Mitsubishi mp286L Laptop Personal Computer Brochure undated.
 Grid Brochure undated.
 Dauphin Laptop Computer Brochure undated.
 MicroDIRECT Brochure undated.
 SuperSport Brochure undated.
 Panasonic KX-D4930 Advertisement undated.
 Ampere WS-1 Advertisement undated.
 NEC Contrast undated.
 NEC Starlet PC-8401A Advertisement undated.
 Victor Technologies, V 286 P Catalog undated.
 Visual Computer Brochure undated.
 Gavilan Mobile Computer Brochure undated.
 Olivetti Personal Computer M15 Brochure undated.

Primary Examiner—Wallace R. Burke
Assistant Examiner—Freda S. Nunn
Attorney, Agent, or Firm—Banner, Birch, McKie & Beckett

[57]

CLAIM

The ornamental design for an electronic computer, as shown and described.

DESCRIPTION

FIG. 1 is a top, front and right side perspective view of an electronic computer showing my new design;
 FIG. 2 is a front elevational view thereof;
 FIG. 3 is a rear elevational view thereof;
 FIG. 4 is a top plan view thereof;
 FIG. 5 is a bottom plan view thereof;
 FIG. 6 is a left side elevational view thereof;
 FIG. 7 is a top, front and right side perspective view thereof in closed position; and,
 FIG. 8 is a left side elevational view thereof in closed position.

FIG. 1

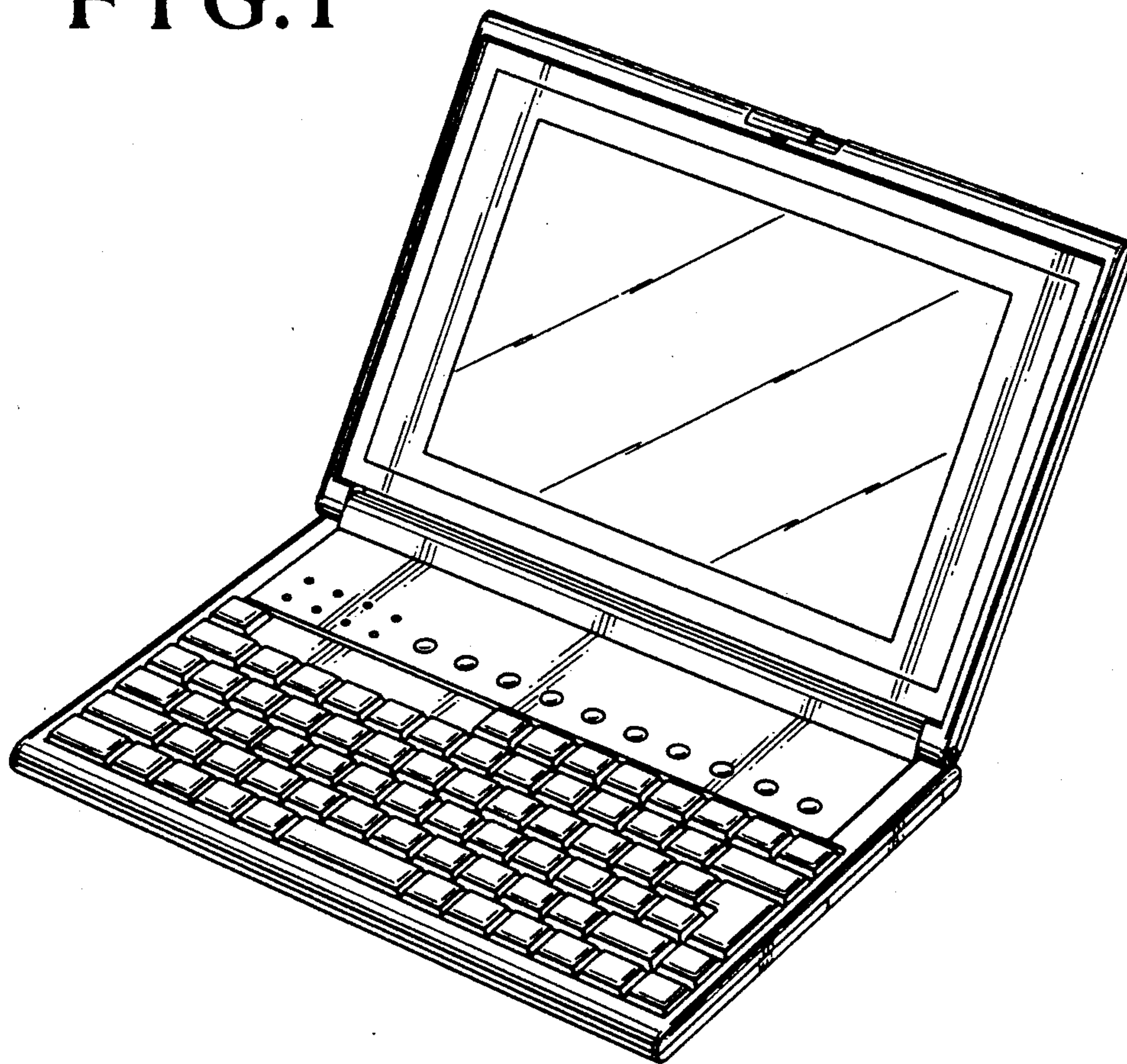

FIG. 2

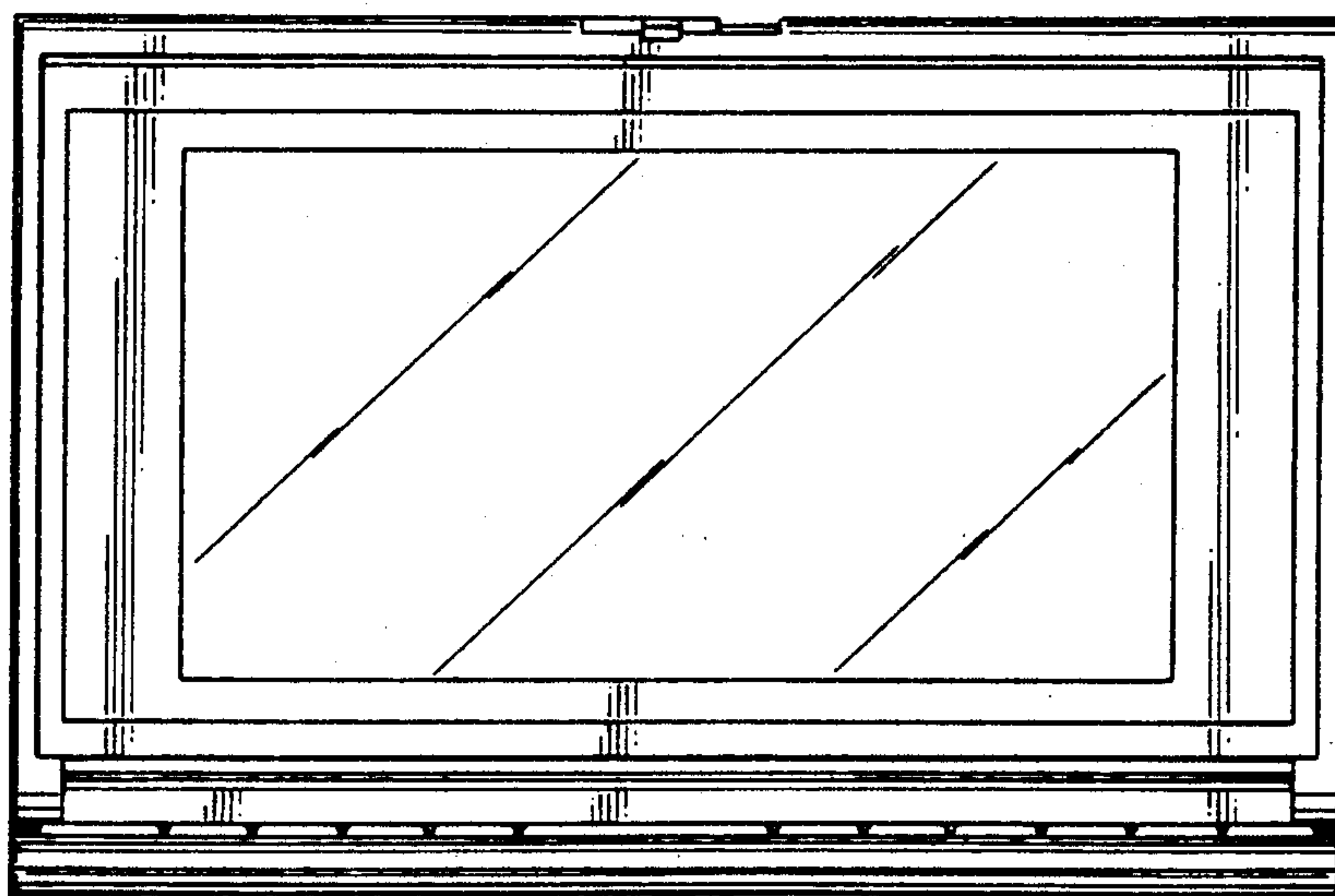

FIG.3

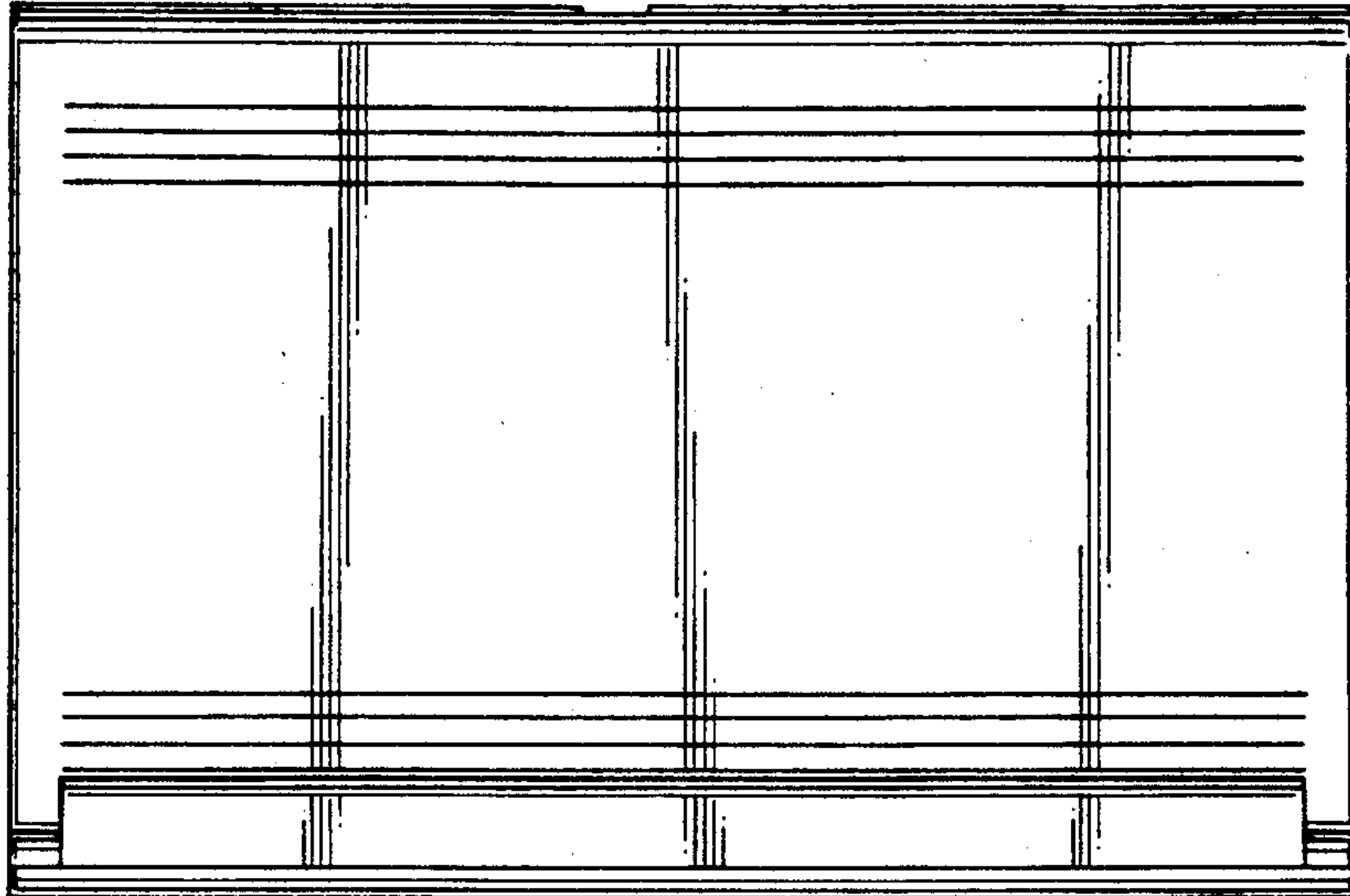

FIG.4

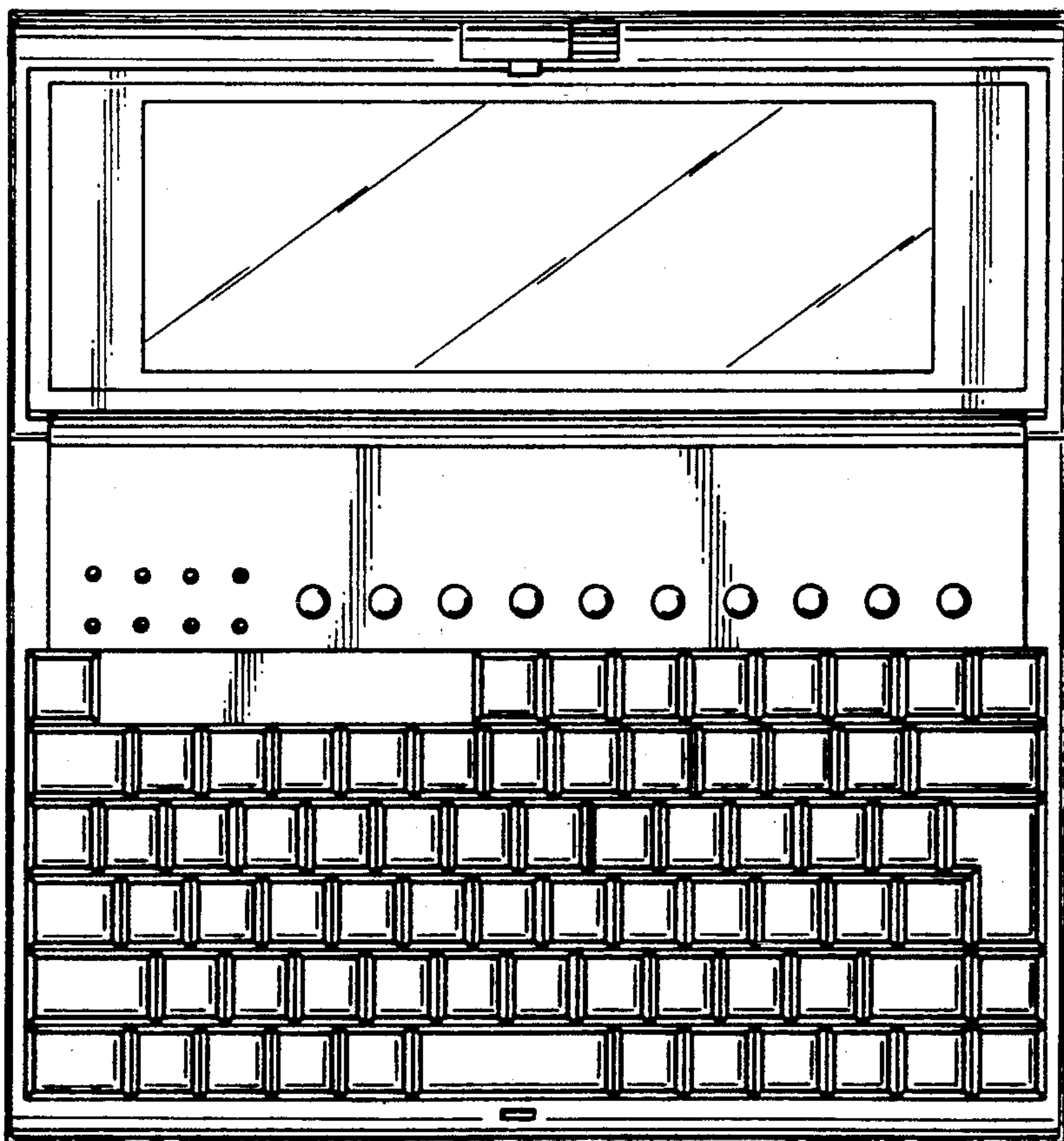

FIG.5

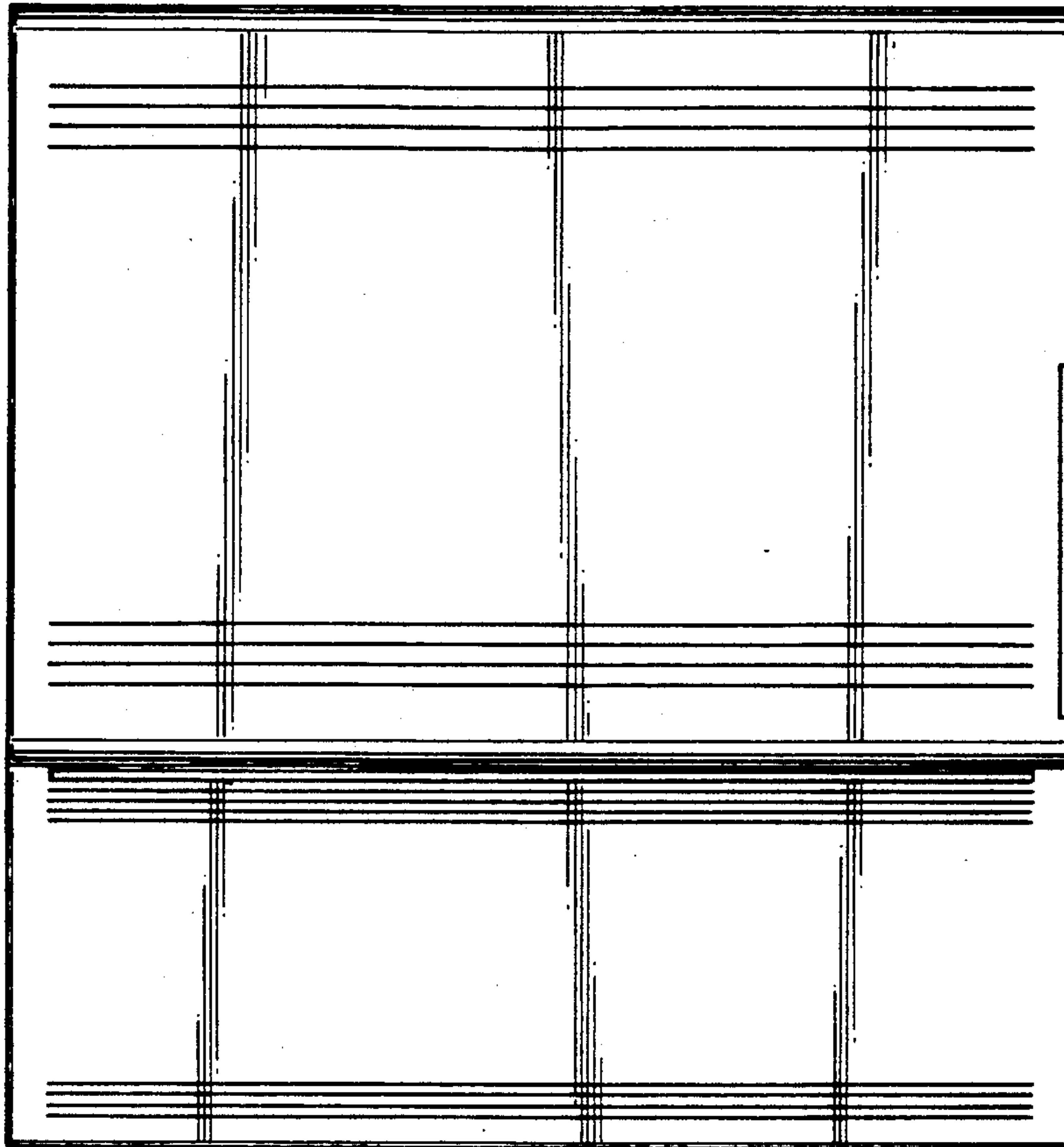

FIG.6

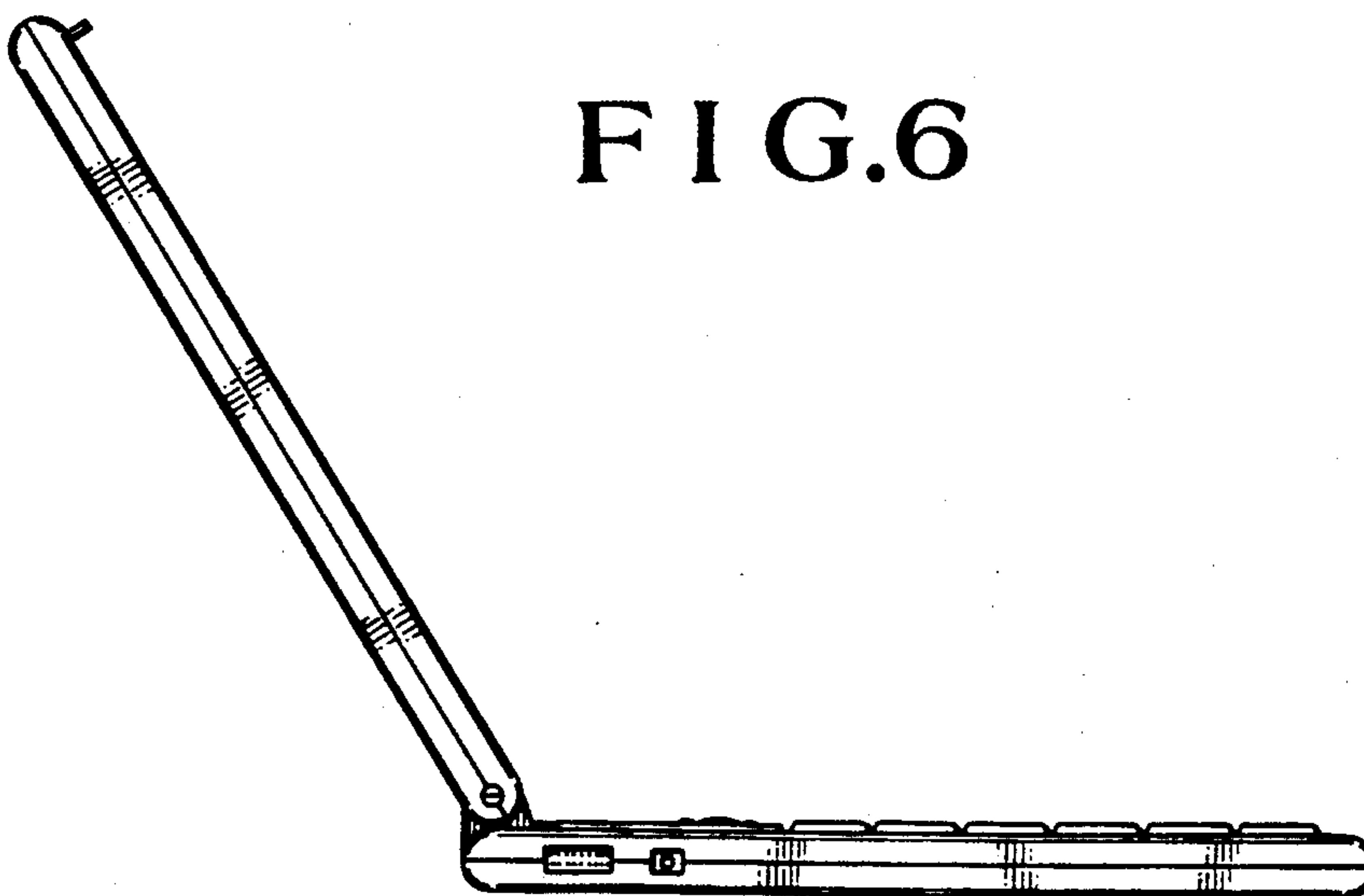

FIG. 7

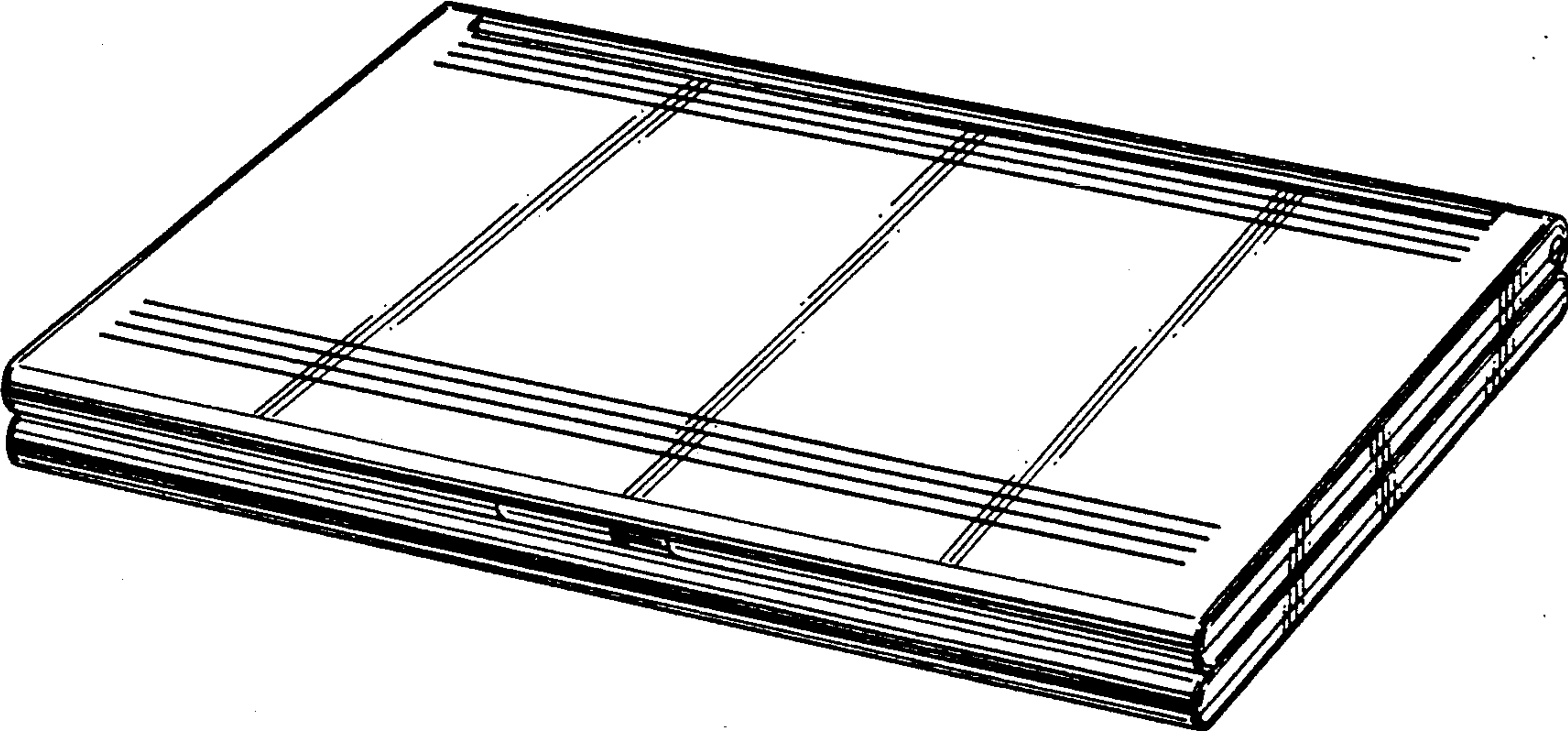

FIG. 8

