



US00D336233S

United States Patent [19]
Zimmermann

[11] **Patent Number: Des. 336,233**
[45] **Date of Patent: ** Jun. 8, 1993**

[54] **COLLAPSIBLE CRANK HANDLE**

[75] **Inventor: Norbert Zimmermann, Freiburg, Fed. Rep. of Germany**
[73] **Assignee: Otto Ganter & Co. KG, Furtwangen, Fed. Rep. of Germany**

[**] **Term: 14 Years**

[21] **Appl. No.: 749,411**

[22] **Filed: Aug. 23, 1991**

[30] **Foreign Application Priority Data**

Feb. 26, 1991 [DE] Fed. Rep. of Germany M 91 01 373.9

[52] **U.S. Cl. D8/309**

[58] **Field of Search D8/300, 309, 400; 74/545, 547; 16/110 R, 115**

[56] **References Cited**

U.S. PATENT DOCUMENTS

D. 289,370 4/1987 Bertani D8/309
D. 292,550 11/1987 Jackson D8/309
D. 305,544 1/1990 Ganter D8/309
3,857,300 12/1974 O'Dell 74/547

OTHER PUBLICATIONS

Kipp/Elesa brochure; 1985; p. 16; Fold-A-Way Handle.

Primary Examiner—B. J. Bullock
Attorney, Agent, or Firm—Larry J. Palguta

[57] **CLAIM**

The ornamental design for a collapsible crank handle, as shown and described.

DESCRIPTION

FIG. 1 is a perspective view of the collapsible crank handle, in its opened position;
FIG. 2 is a right side view thereof;
FIG. 3 is a front view thereof;
FIG. 4 is a top view thereof;
FIG. 5 is a left side view thereof;
FIG. 6 is a rear view thereof;
FIG. 7 is a bottom plan view thereof;
FIG. 8 is a perspective view thereof in its closed position;
FIG. 9 is a right side view of FIG. 8;
FIG. 10 is a front view of FIG. 8;
FIG. 11 is a top view of FIG. 8;
FIG. 12 is a bottom view of FIG. 8;
FIG. 13 is a left side view of FIG. 8; and,
FIG. 14 is a rear view of FIG. 8.

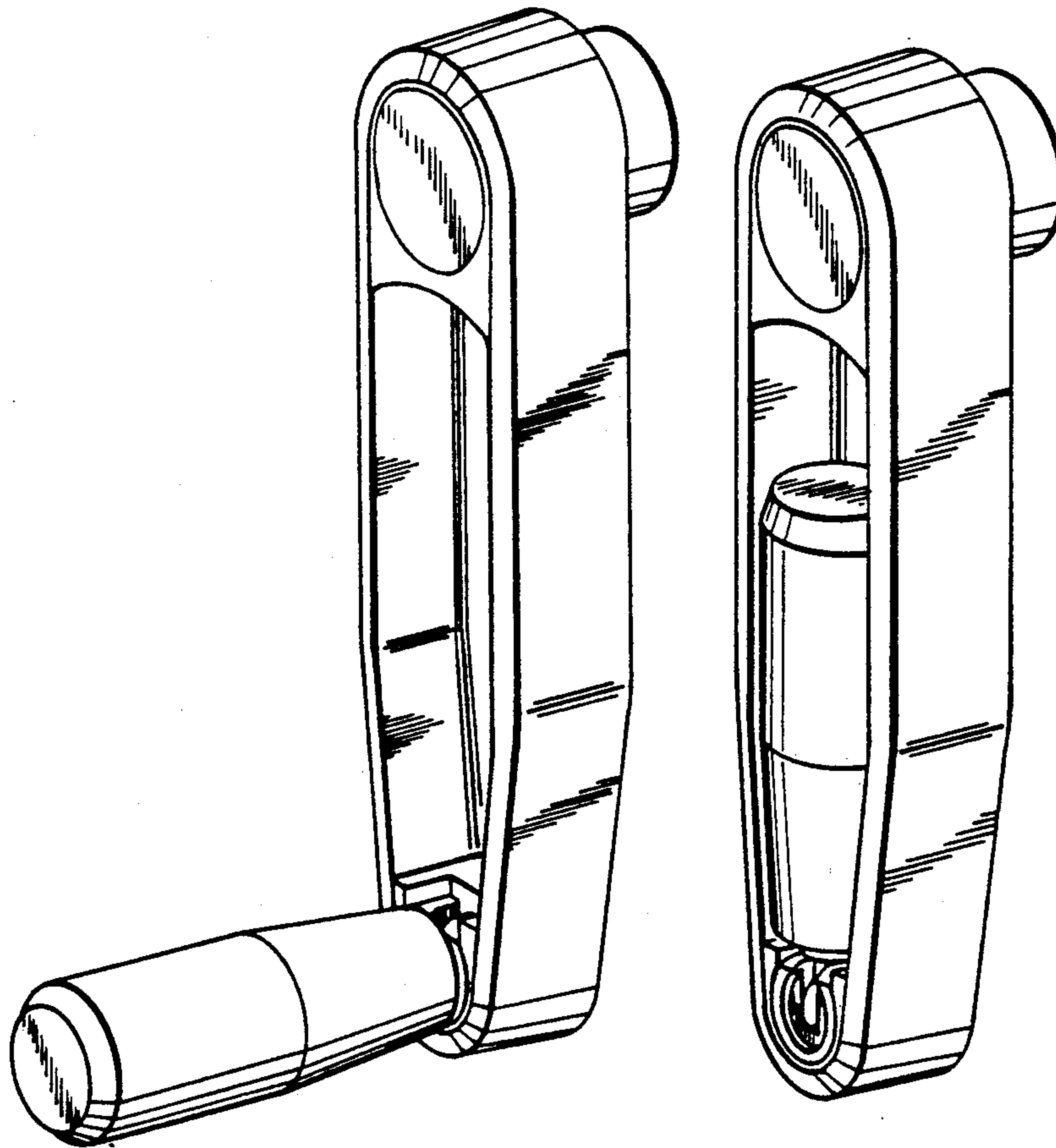

Fig. 1

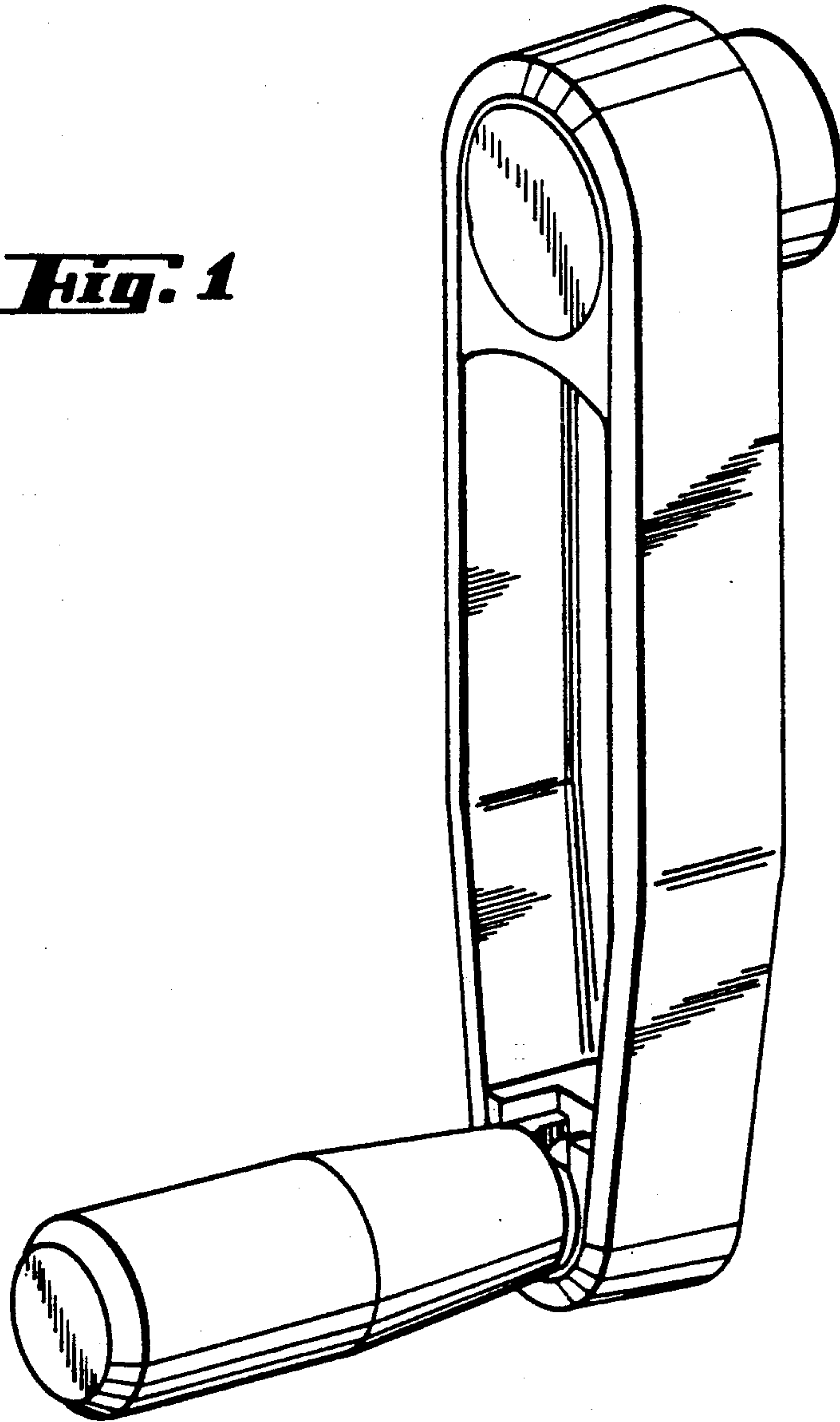

Fig. 2

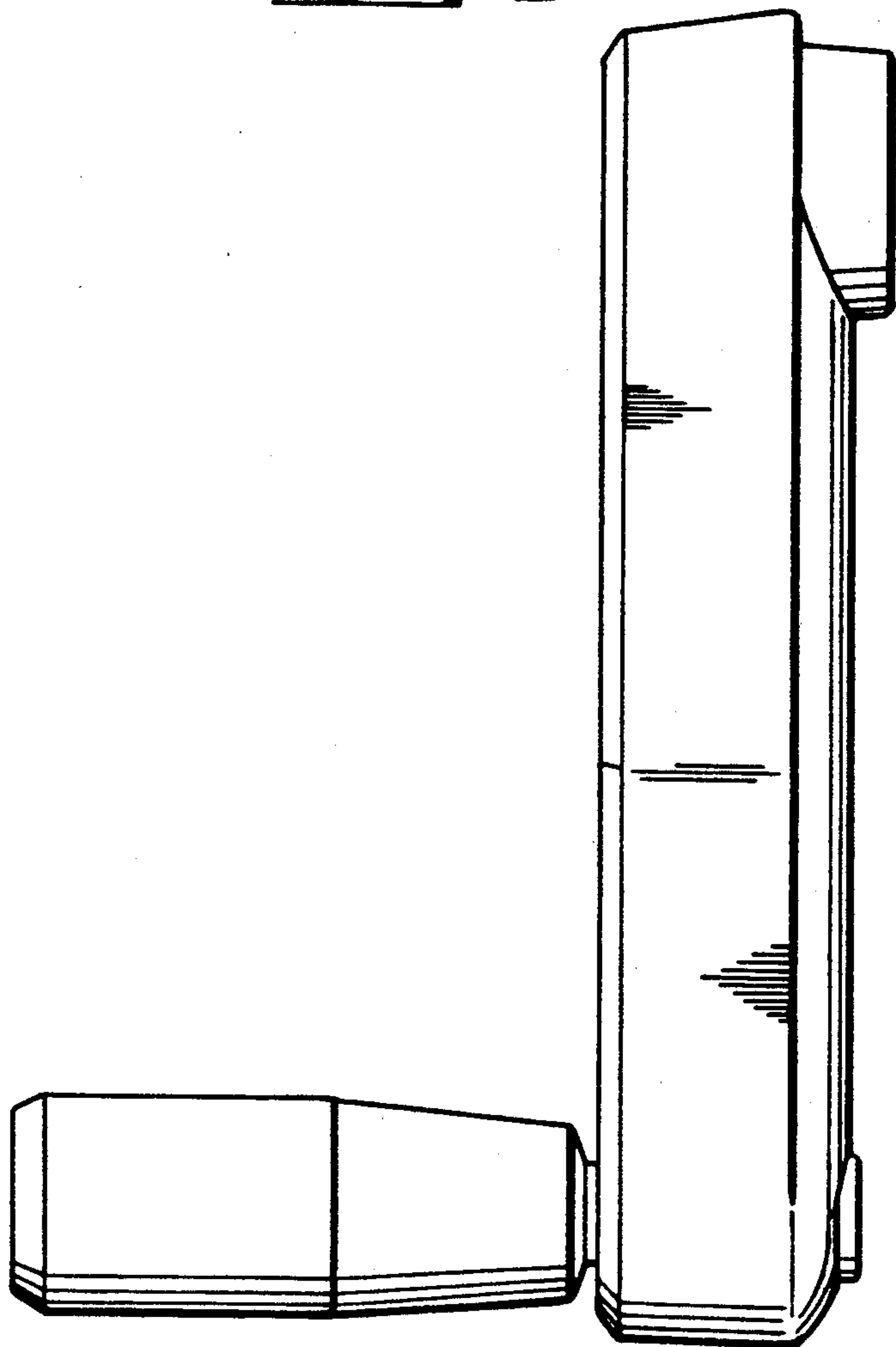

Fig. 3

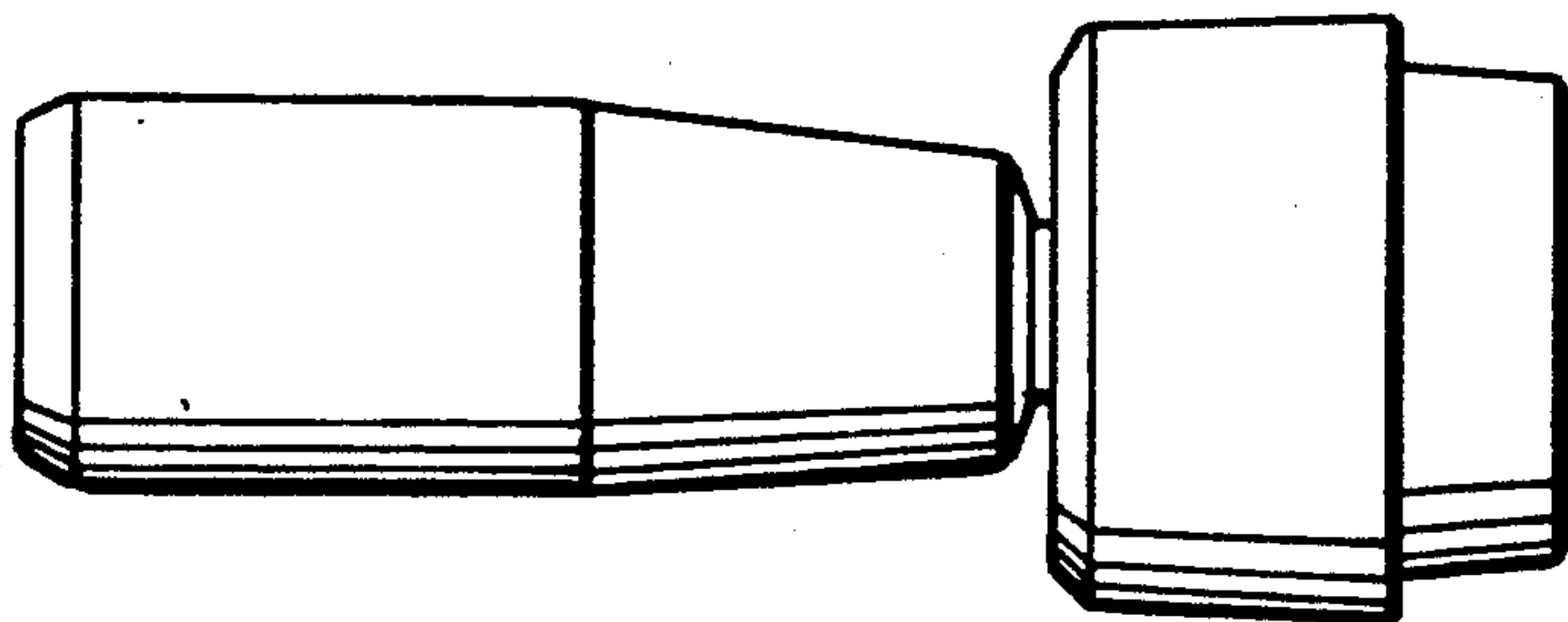
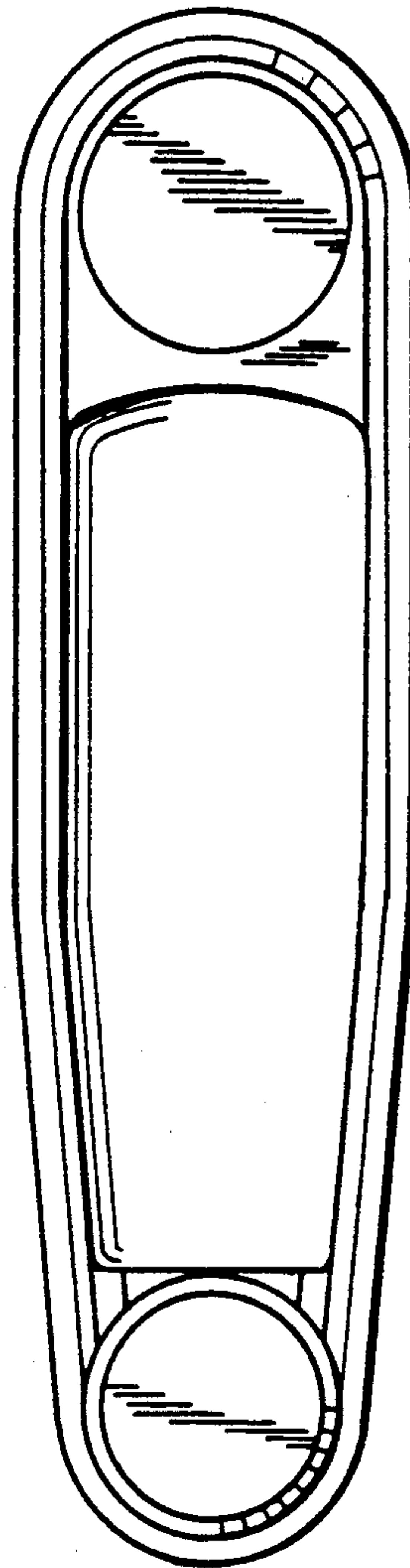

Fig. 4

Fig. 7

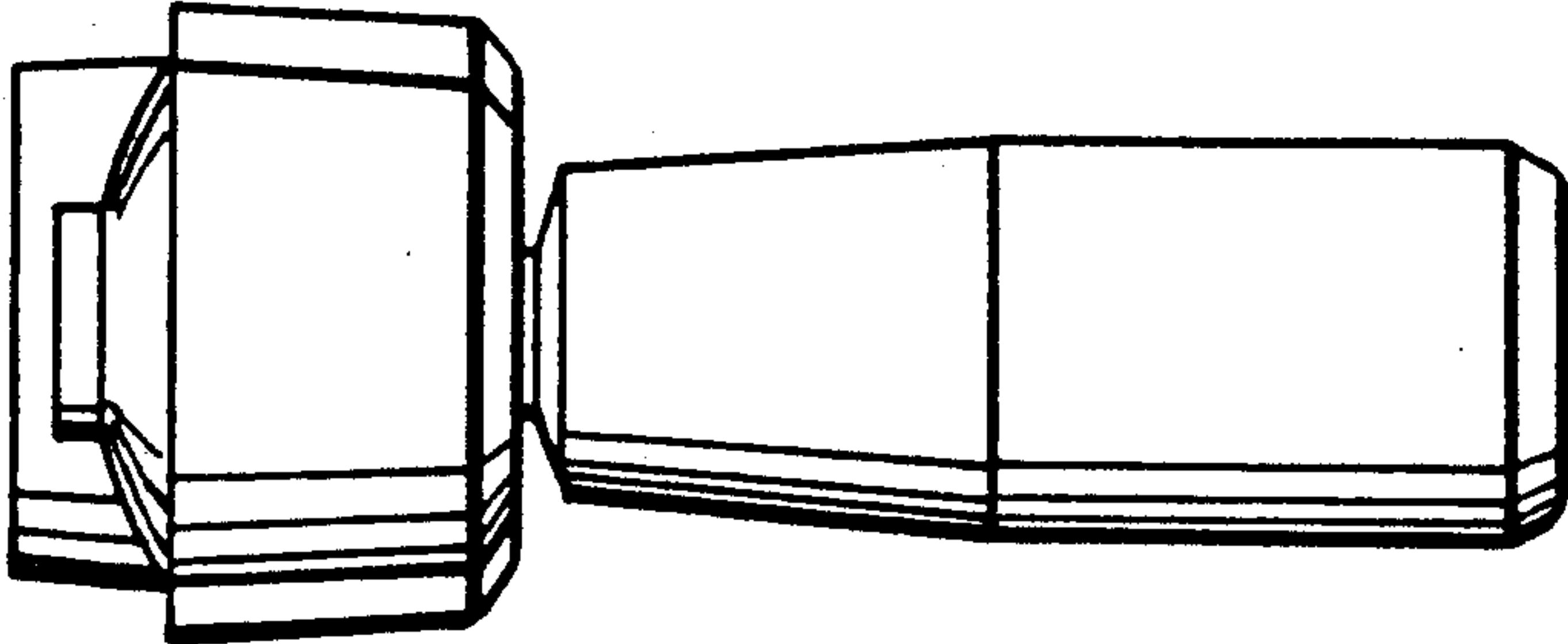

Fig. 5

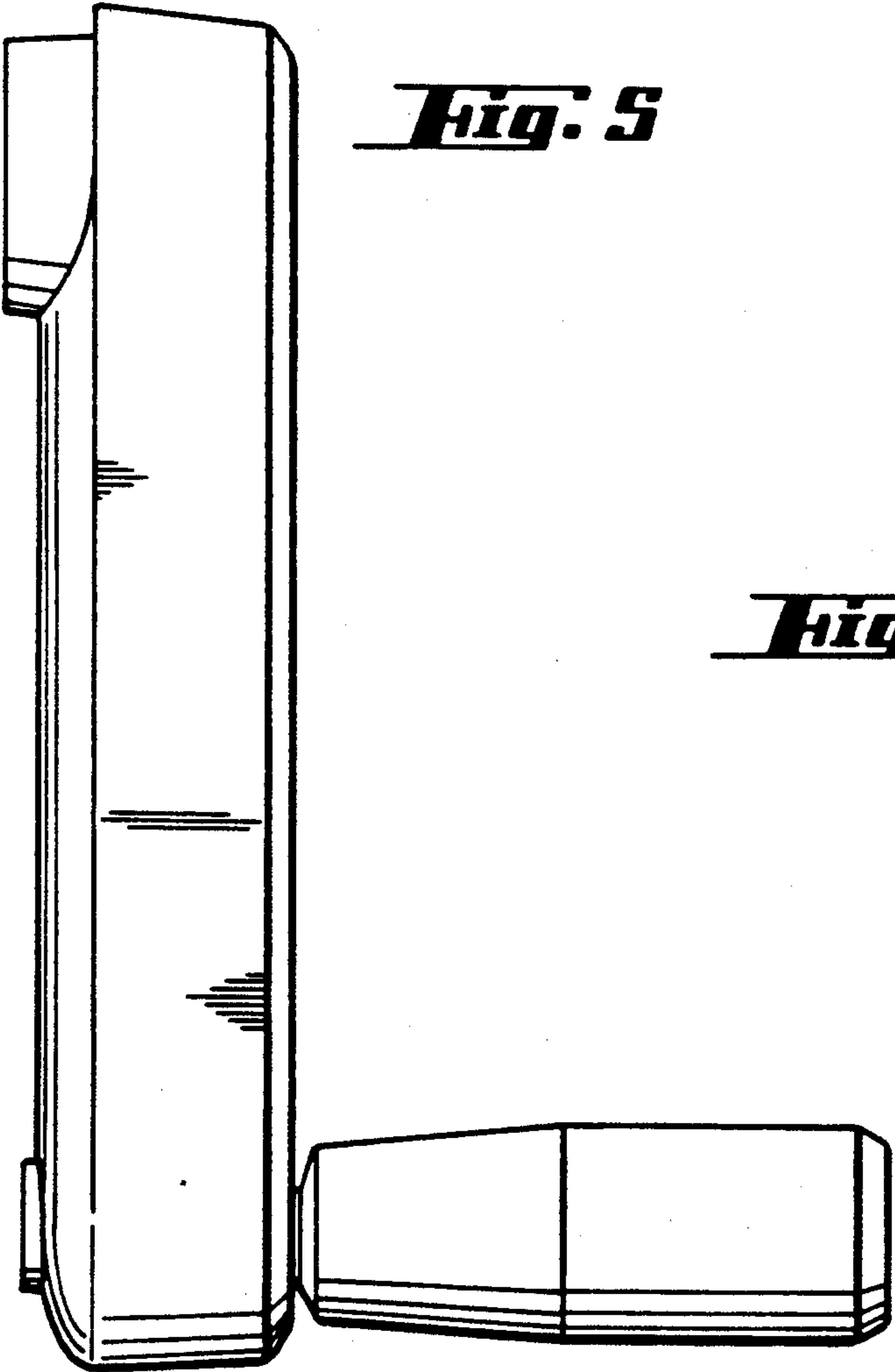

Fig. 6

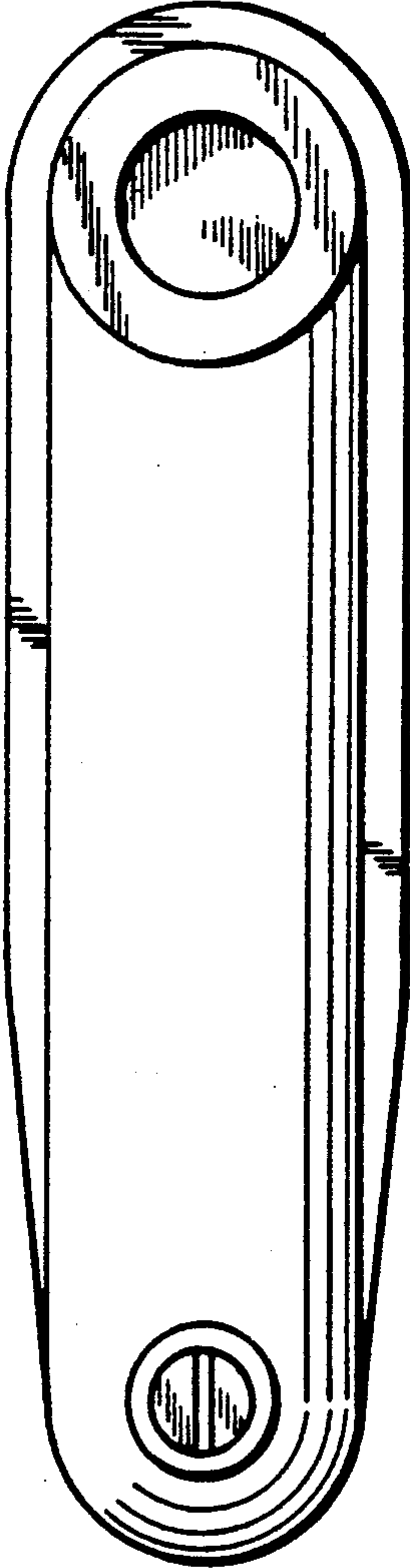

Fig. 8

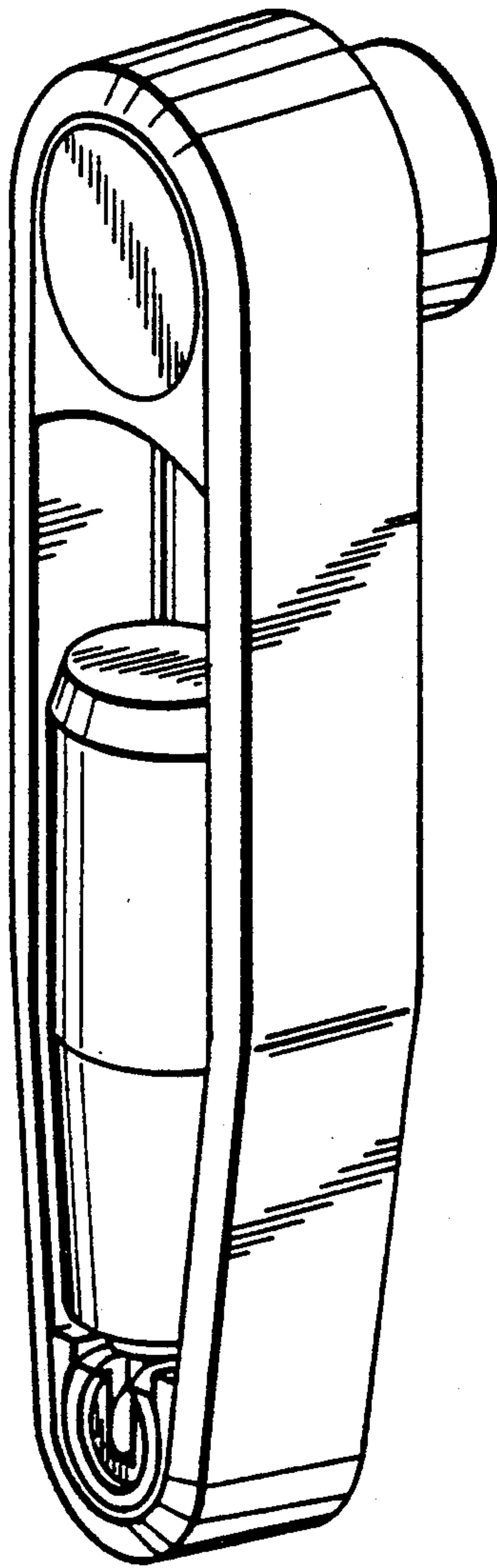

Fig. 9

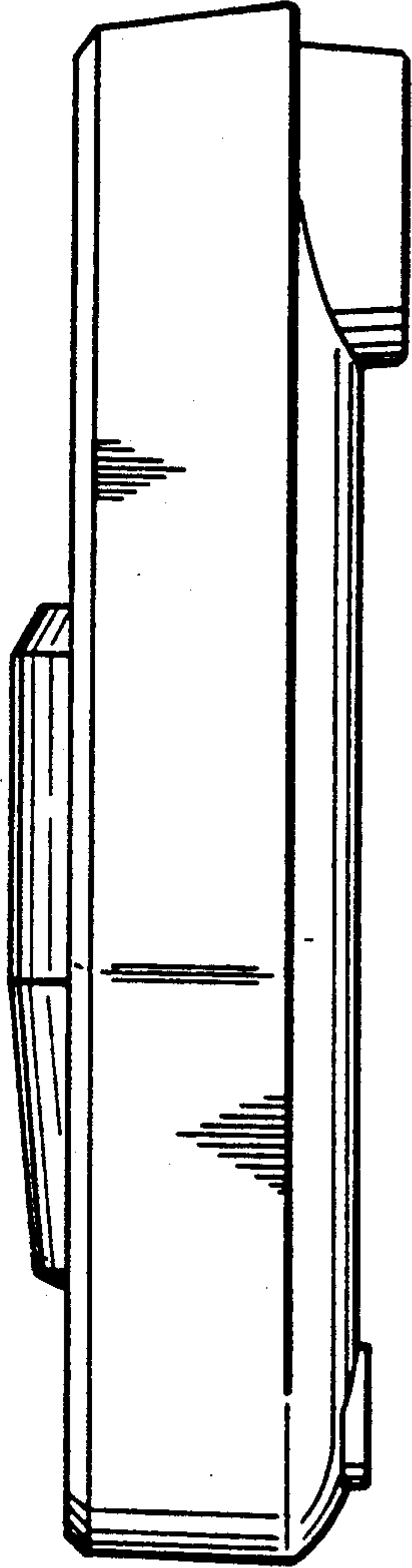

Fig. 10

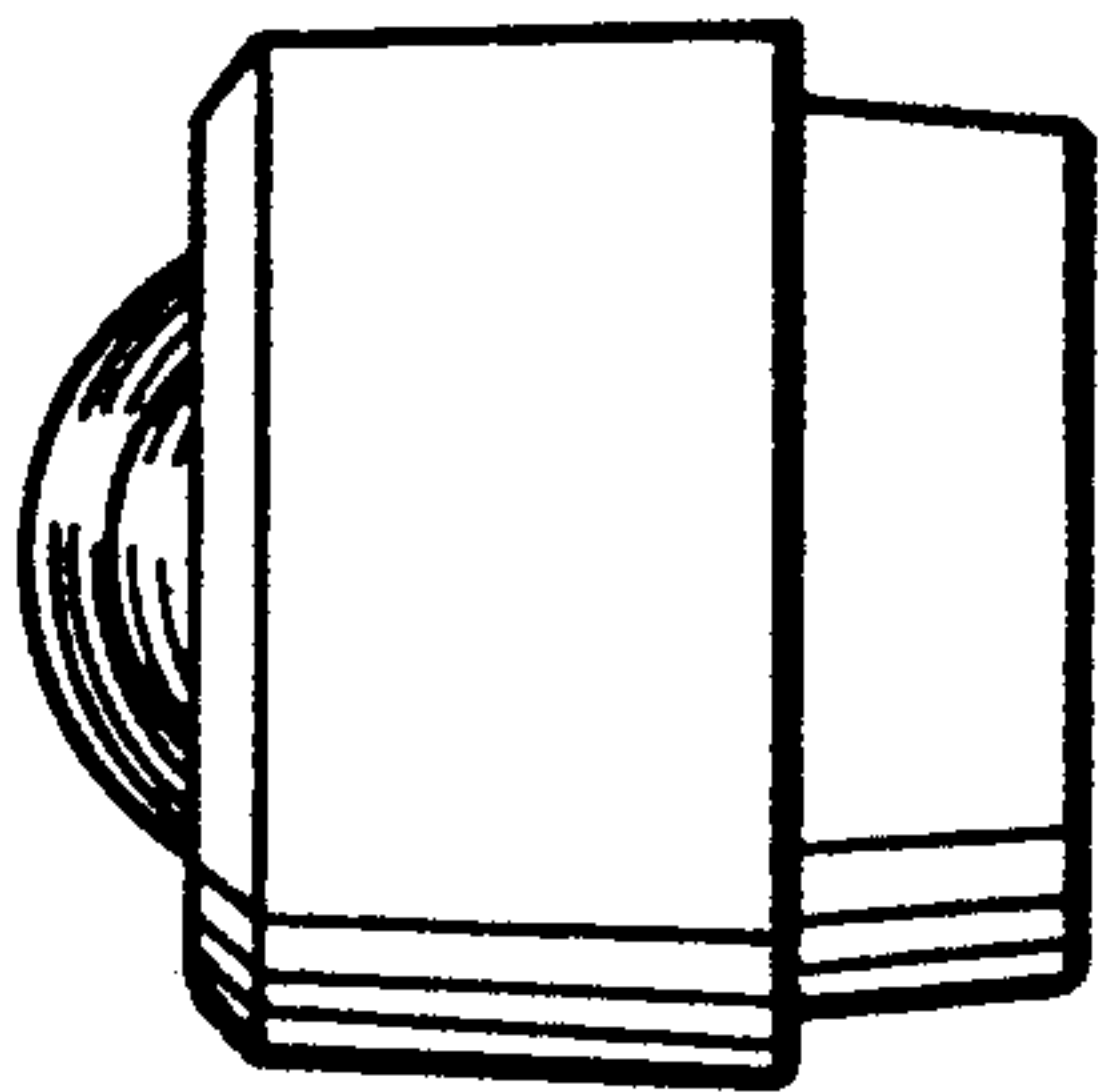
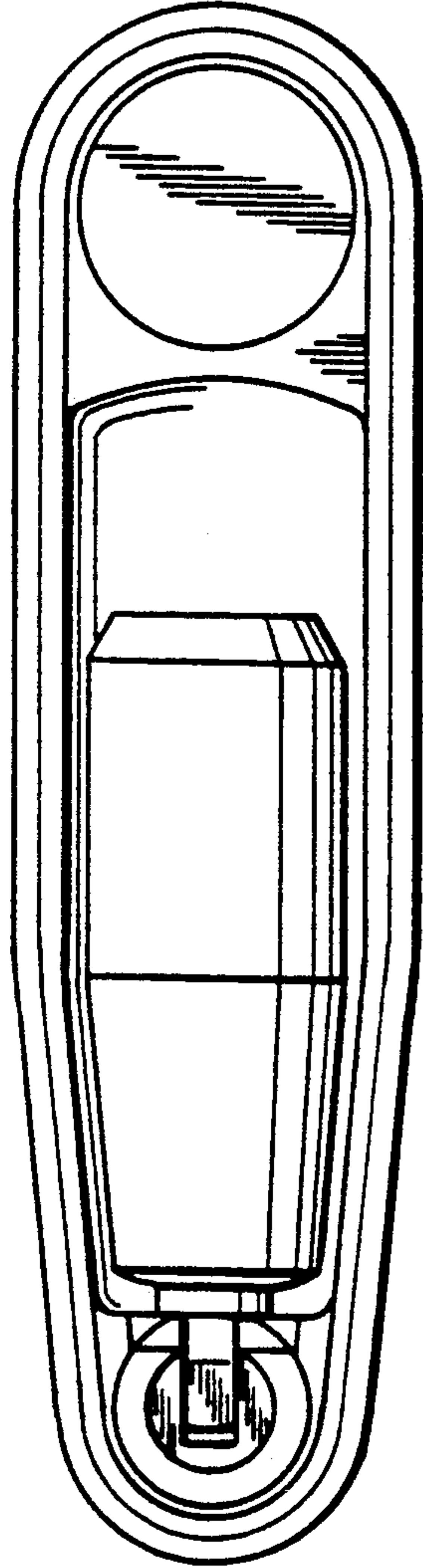

Fig. 11

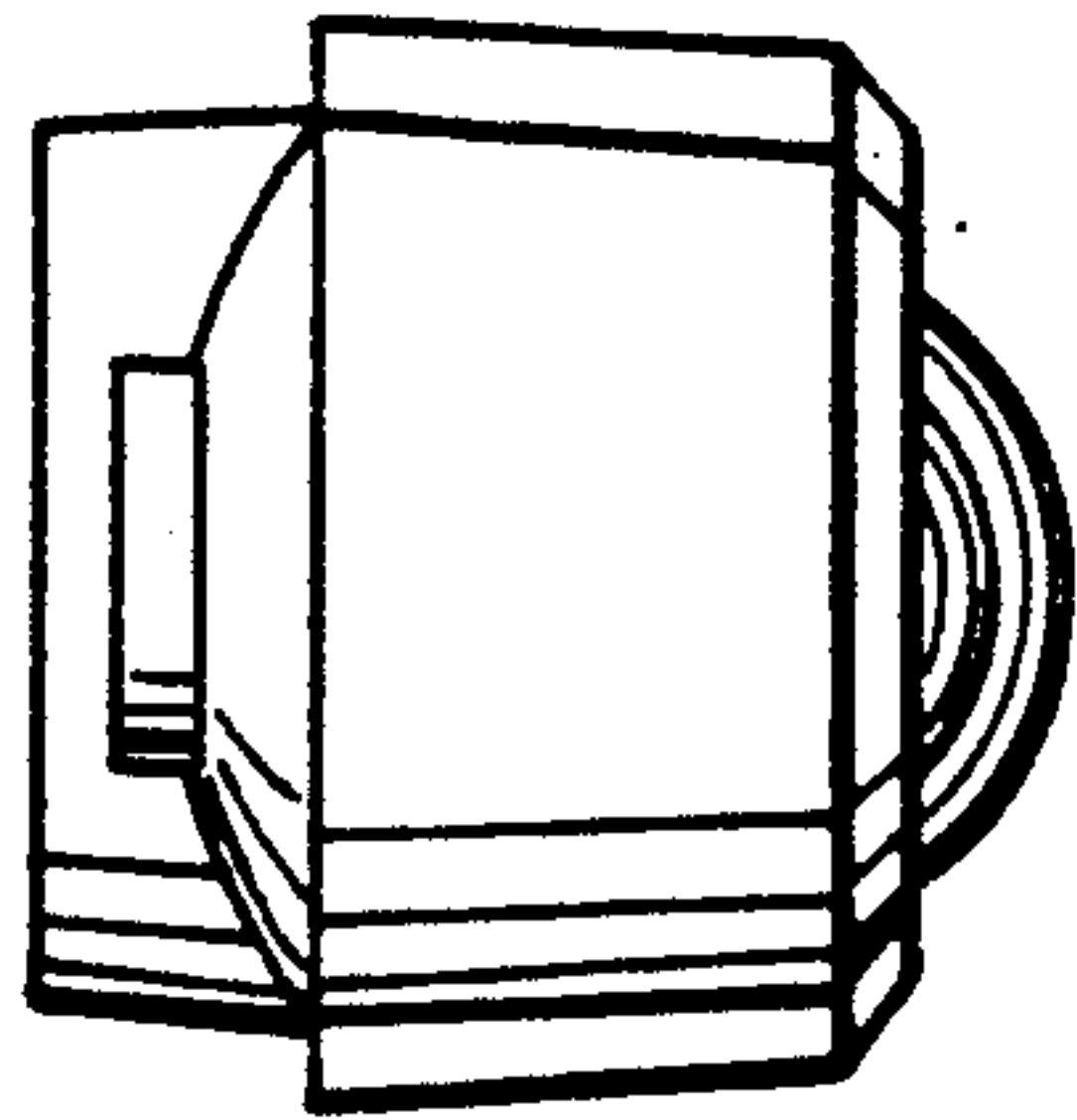

Fig. 12

Fig. 13

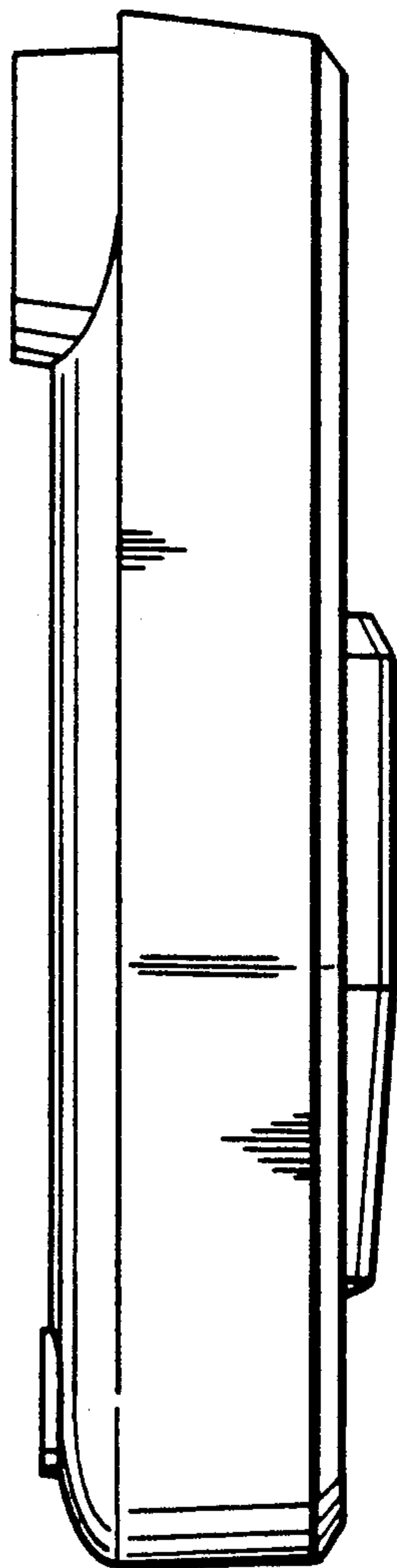

Fig. 14

