



US00D336167S

United States Patent [19]

[11] Patent Number: **Des. 336,167**

Yamasaki et al.

[45] Date of Patent: **** Jun. 8, 1993**

[54] **MASSAGING CHAIR**

4,055,170 10/1977 Nohmura 128/33
4,064,376 12/1977 Yamada 128/33 X
5,033,458 7/1991 Sperr 128/33

[75] Inventors: **Yoshikiyo Yamasaki, Sakai;
Shinichiro Fujimoto, Osaka, both of
Japan**

Primary Examiner—Alan P. Douglas
Assistant Examiner—Monica A. Hannon
Attorney, Agent, or Firm—Flynn, Thiel, Boutell & Tanis

[73] Assignees: **Kabushiki Kaisha Japan Health,
Sakai; Kabushiki Kaisha Fuji Iryoki,
Osaka, both of Japan**

[57] CLAIM

[**] Term: **14 Years**

The ornamental design for a massaging chair, as shown and described.

[21] Appl. No.: **602,874**

DESCRIPTION

[22] Filed: **Oct. 24, 1990**

FIG. 1 is a front elevational view of a massaging chair showing our new design;

[52] U.S. Cl. **D6/367; D6/334**

FIG. 2 is a rear elevational view thereof;

[58] Field of Search **D6/333, 349, 356;**

FIG. 3 is a top plan view thereof;

128/33, 36; 297/250

FIG. 4 is a bottom plan view thereof;

FIG. 5 is a right side elevational view thereof;

[56] References Cited

U.S. PATENT DOCUMENTS

D. 102,090 11/1936 Naegele D6/356

D. 103,624 3/1937 Beck D6/356

FIG. 6 is a left side elevational view thereof;

FIG. 7 is a front perspective view thereof; and,

FIG. 8 is a sectional view taken along the lines 8—8 of FIG. 1.

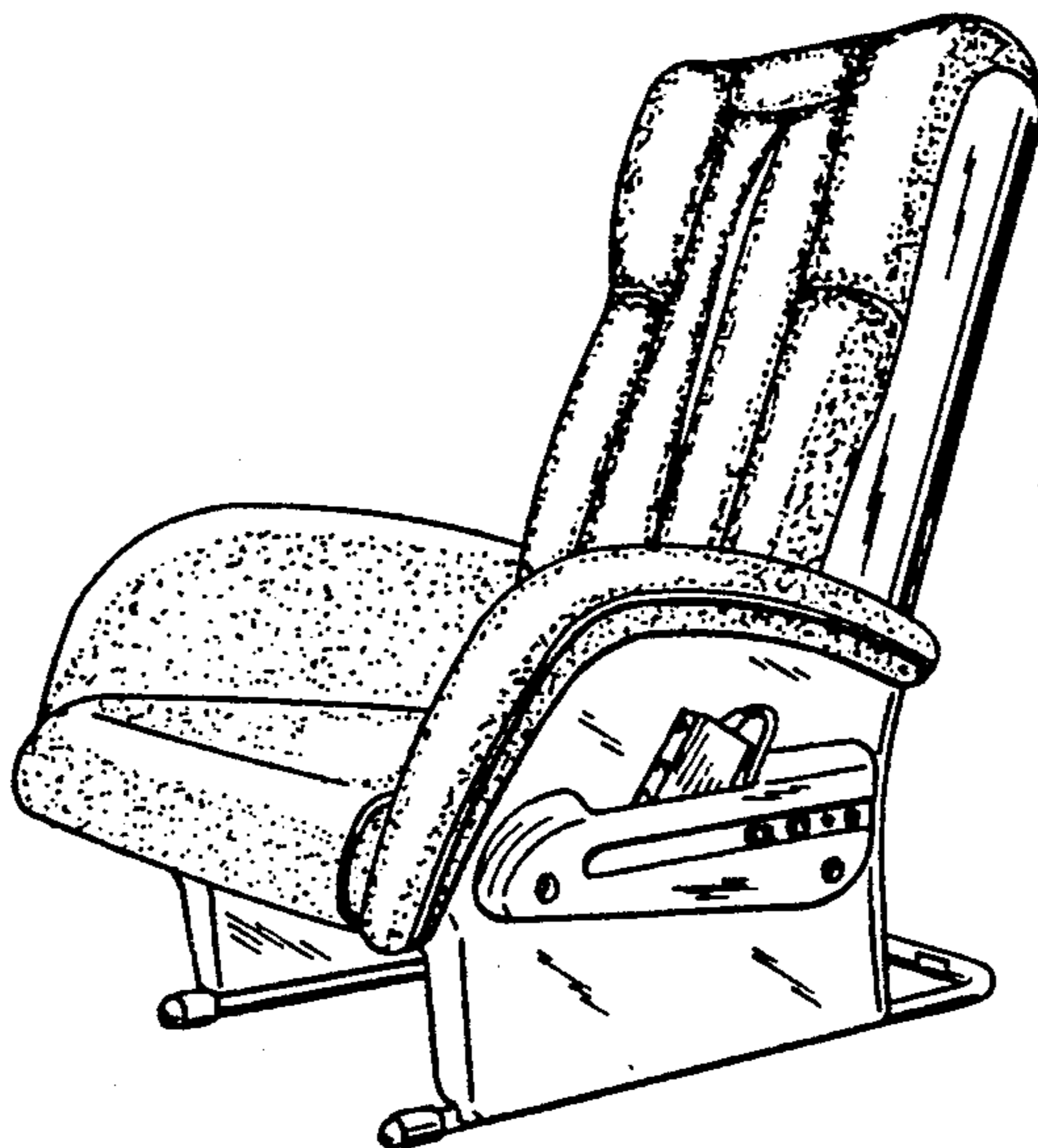

FIG. 1

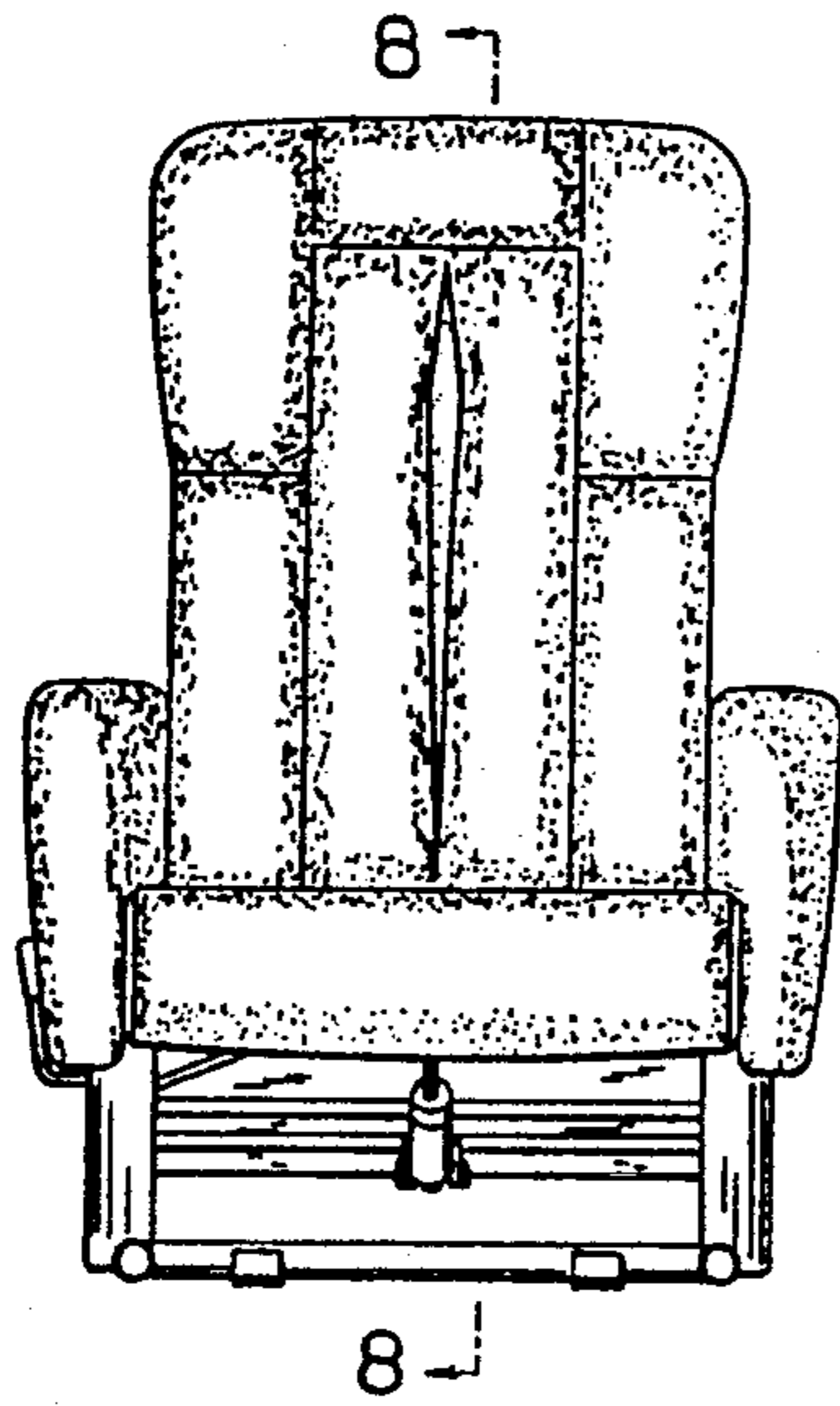

FIG. 2

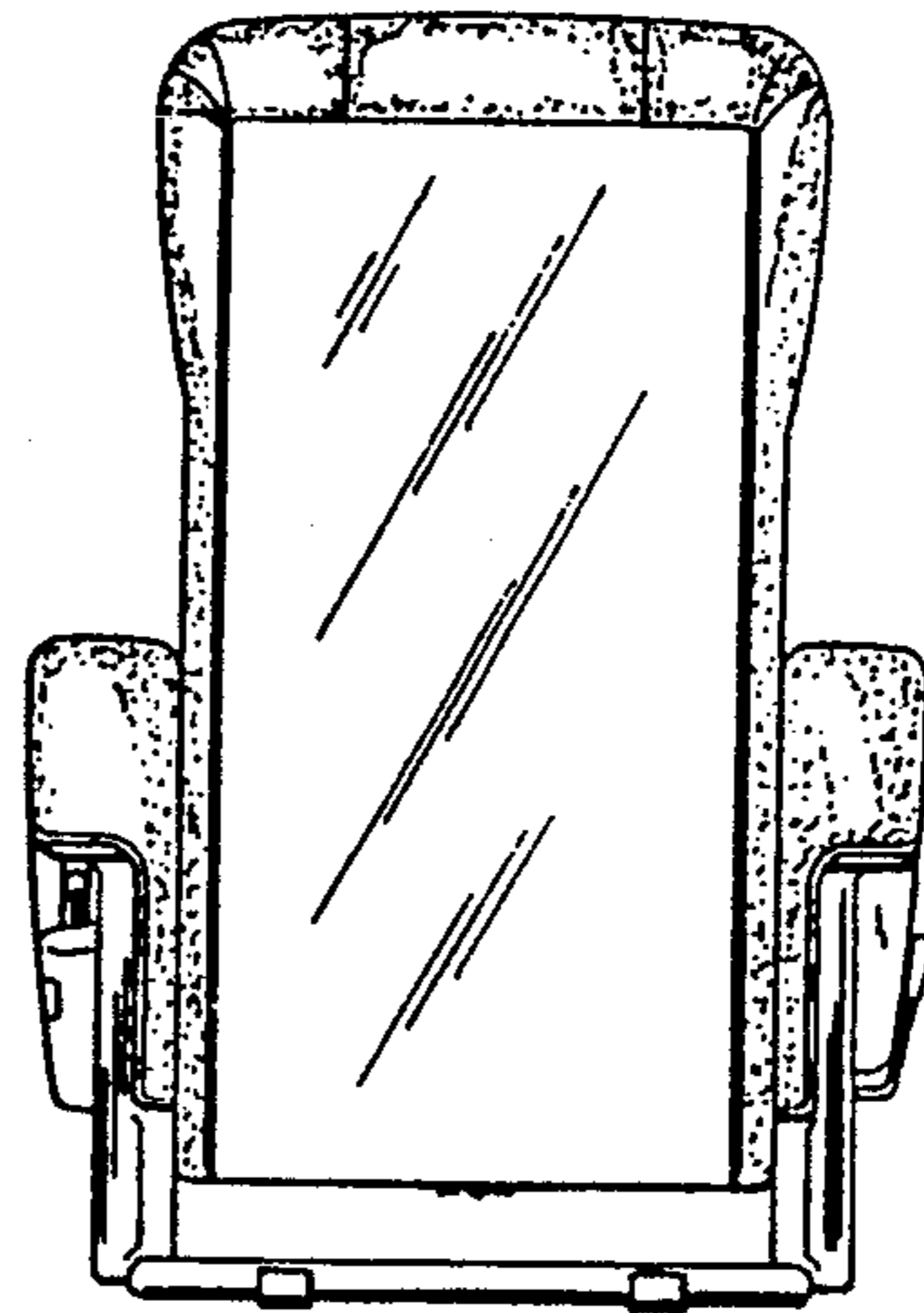

FIG. 3

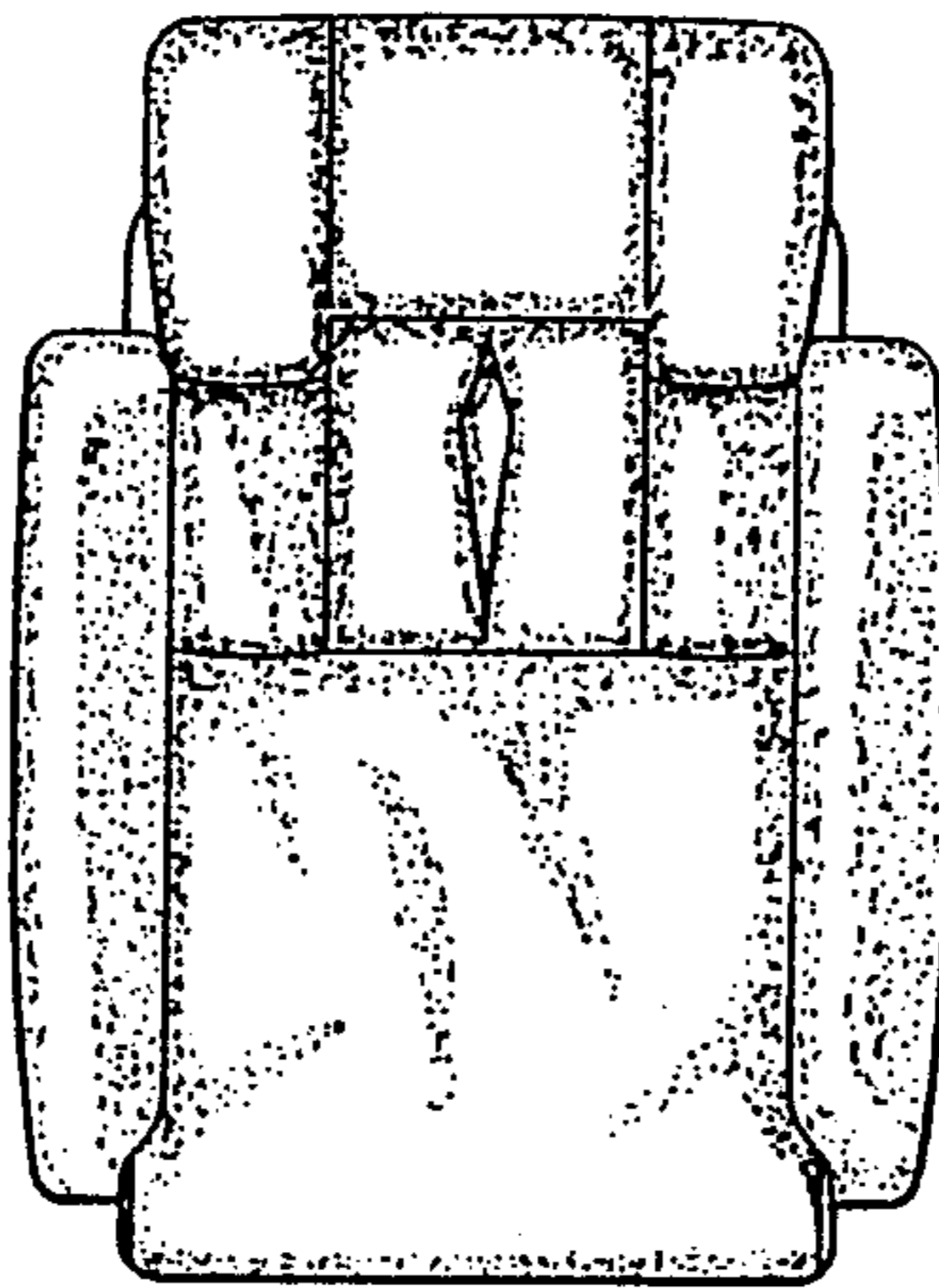

FIG. 4

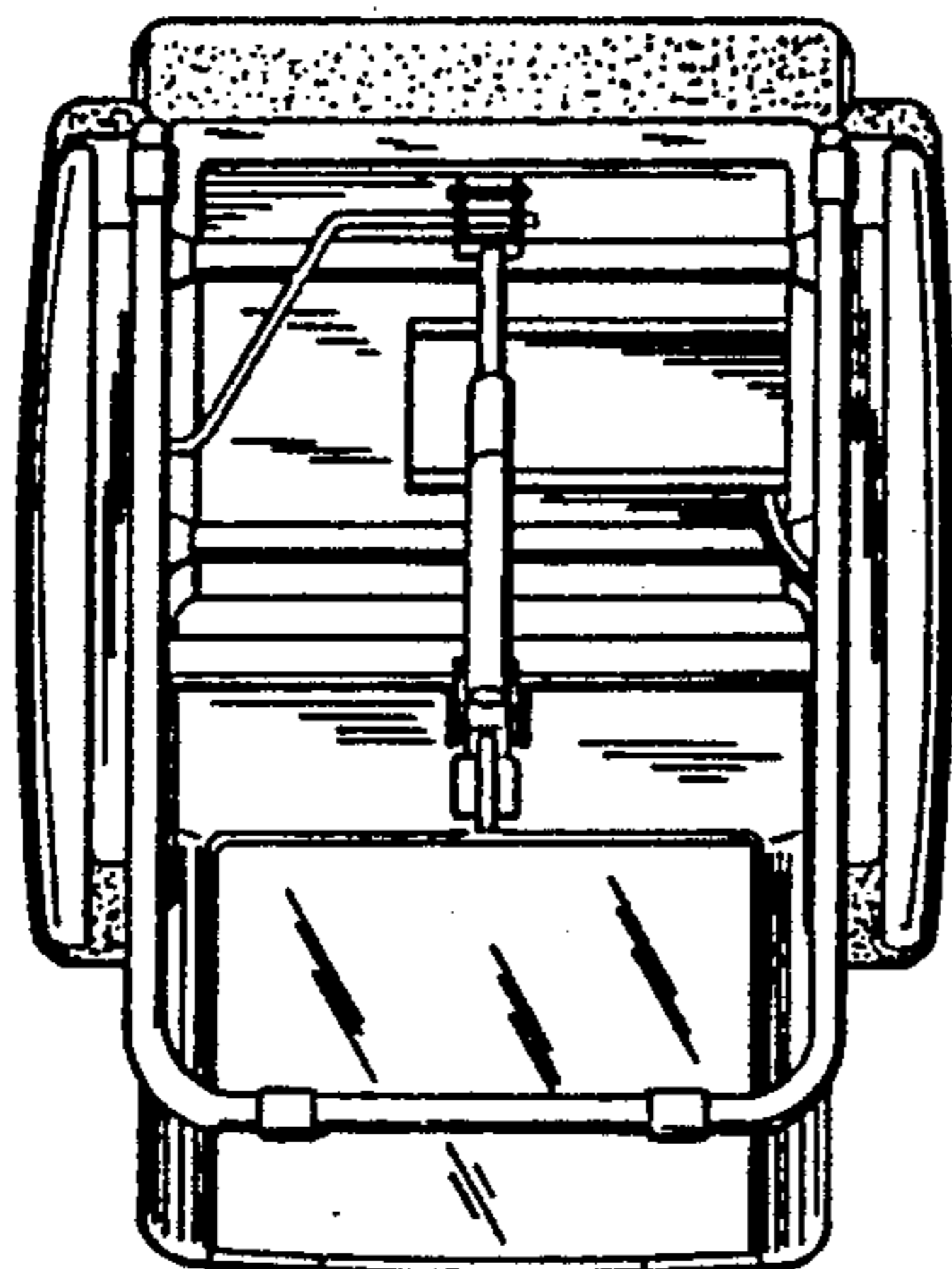

FIG. 5

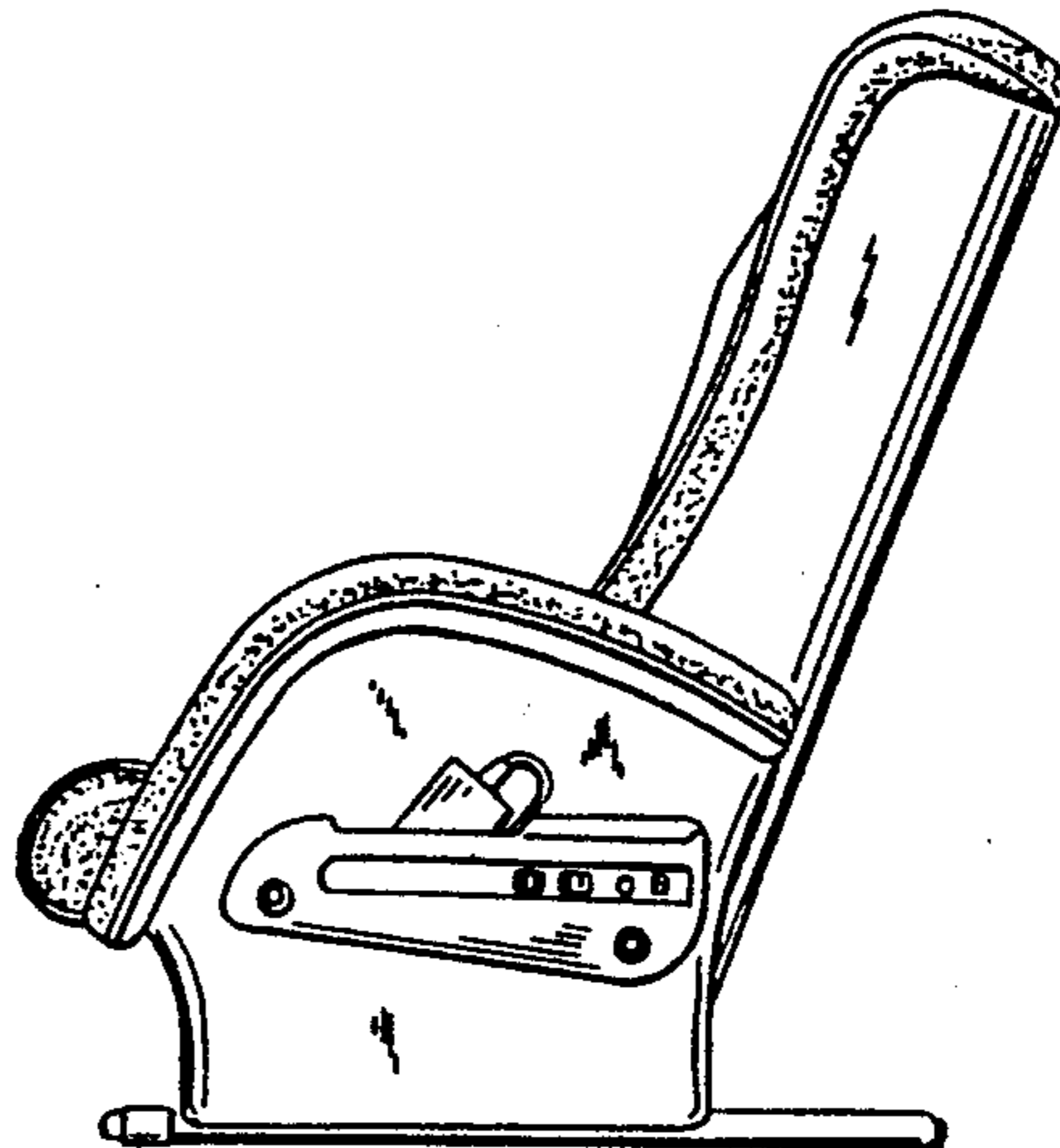

FIG. 6

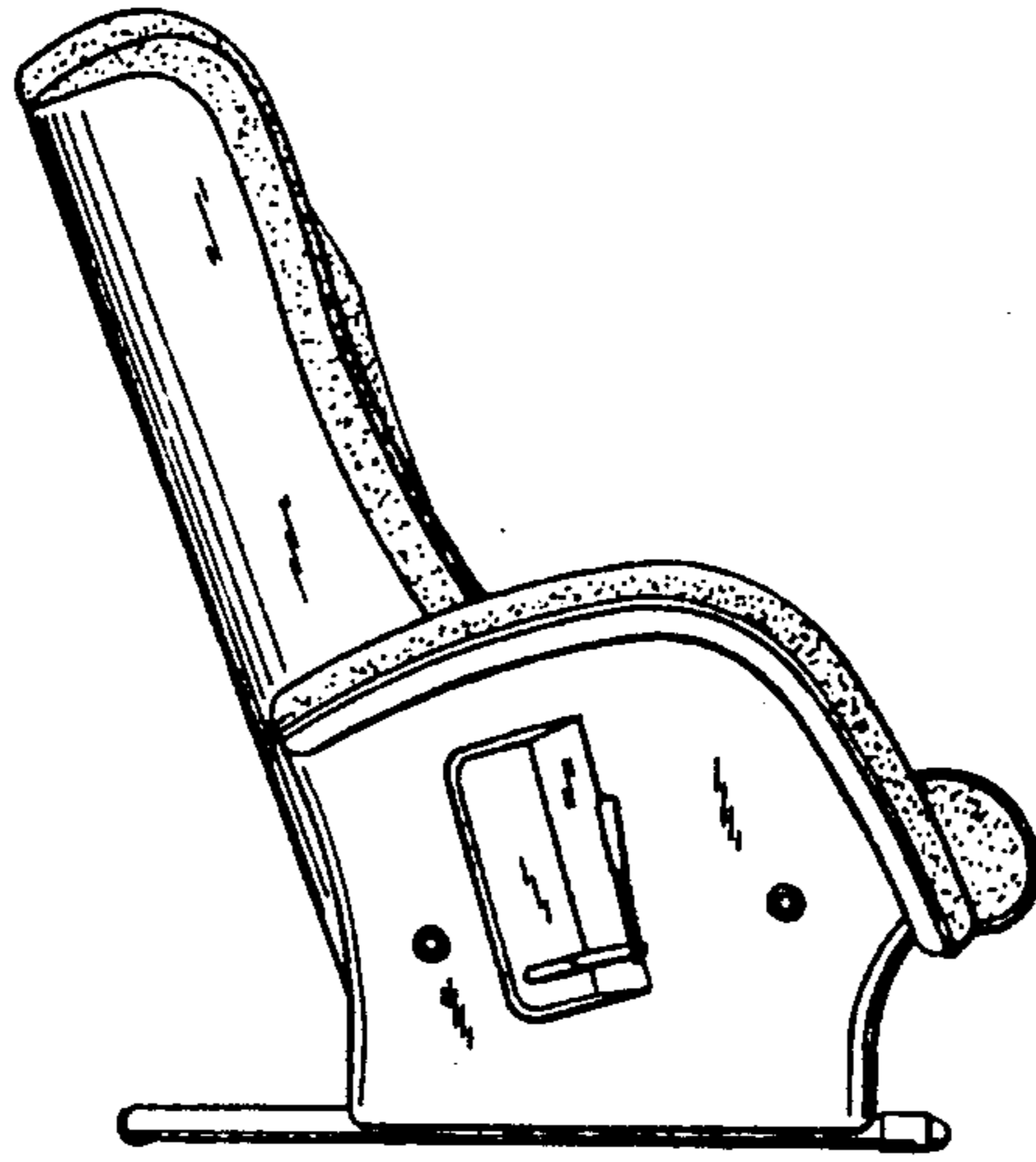

FIG. 7

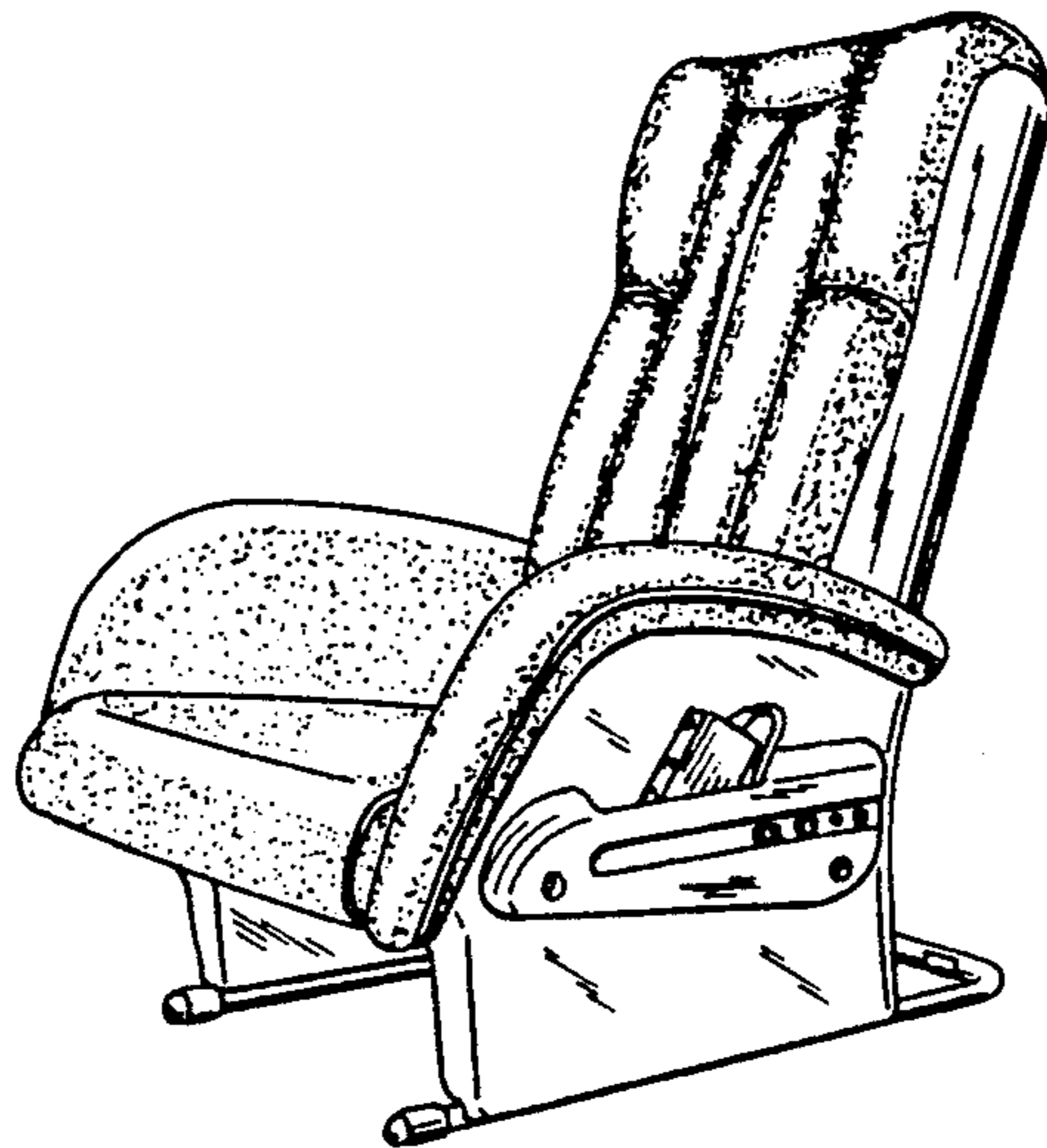

FIG. 8

