



US00D336145S

United States Patent [19]

[11] Patent Number: **Des. 336,145**

Reifslager

[45] Date of Patent: **** Jun. 1, 1993**

[54] **AUXILIARY FLASHING TAIL LIGHT FOR TOWED EQUIPMENT**

D. 316,230 4/1991 Munoz D26/28 X
4,626,967 12/1986 Segoshi 362/61

[76] Inventor: **Michael D. Reifslager, F.M. 710, Ganado, Tex. 77962**

Primary Examiner—Susan J. Lucas
Attorney, Agent, or Firm—Leon Gilden

[**] Term: **14 Years**

[57] **CLAIM**

[21] Appl. No.: **669,282**

The ornamental design for auxiliary flashing tail light for towed equipment, as shown and described.

[22] Filed: **Mar. 14, 1991**

DESCRIPTION

[52] U.S. Cl. **D26/29; D26/32**

[58] Field of Search 362/61, 80, 80.1, 83, 362/83.2; D26/28-36; 340/468-474; D10/114

FIG. 1 is a front elevational view of the auxiliary flashing tail light for towed equipment showing my new design;

FIG. 2 is a rear elevational view thereof;

FIG. 3 is a left side elevational view thereof;

FIG. 4 is a right side elevational view thereof;

FIG. 5 is a top plan view thereof;

FIG. 6 is a bottom plan view thereof; and,

FIG. 7 is a perspective view thereof.

[56] **References Cited**

U.S. PATENT DOCUMENTS

- D. 290,296 6/1987 Caine D26/31
- D. 303,016 8/1989 Yuen D26/29
- D. 313,661 1/1991 Kang D26/31

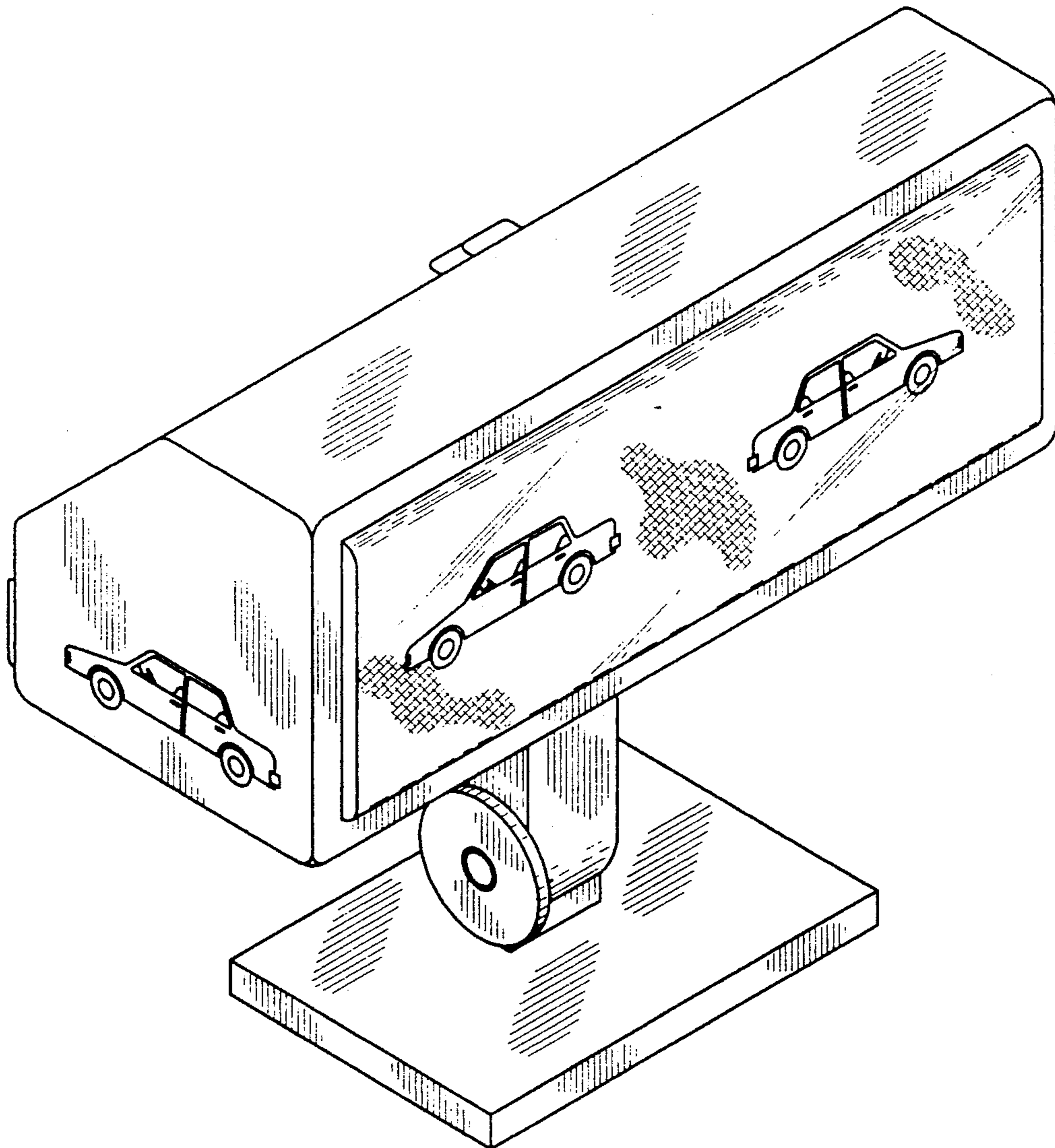

FIG. 1

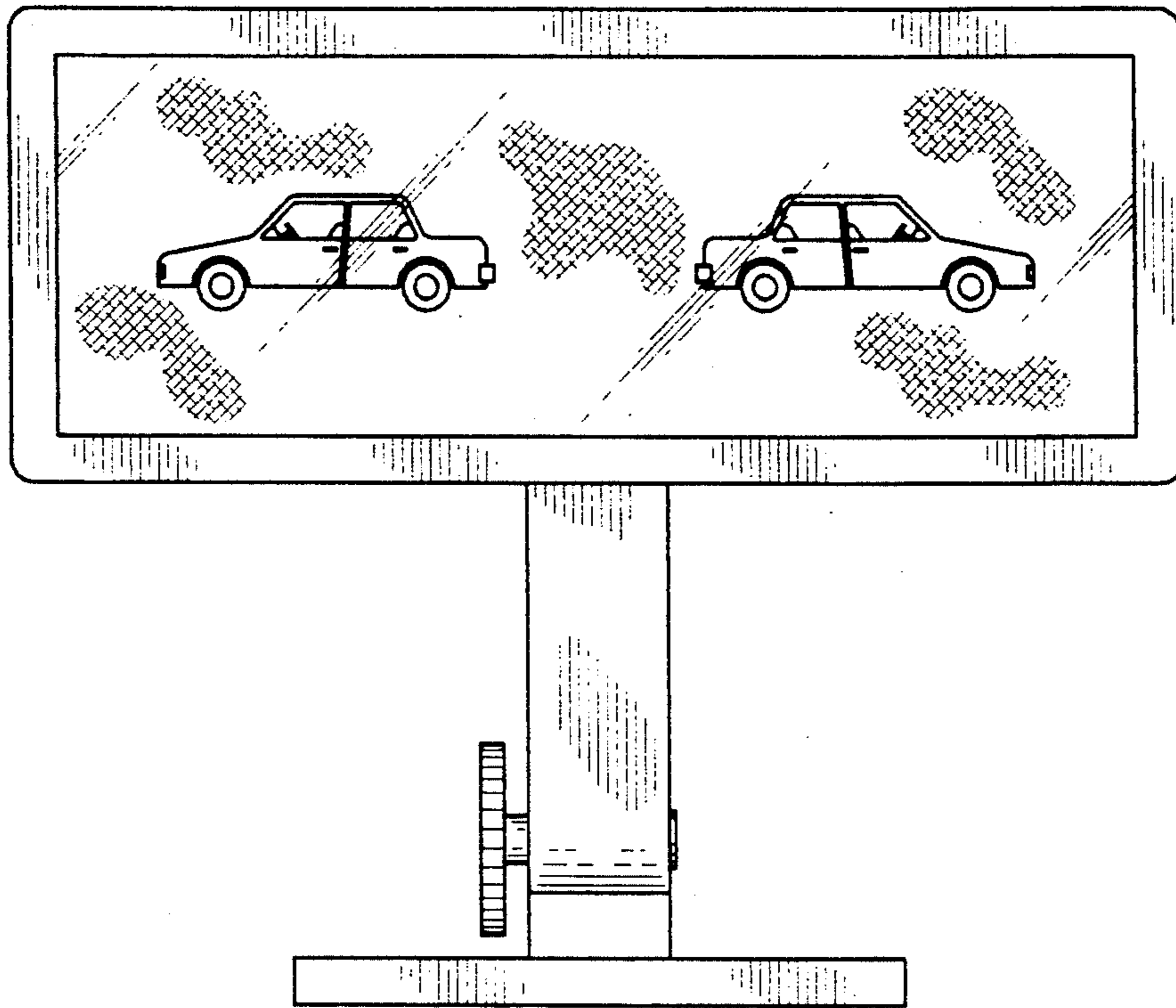

FIG. 2

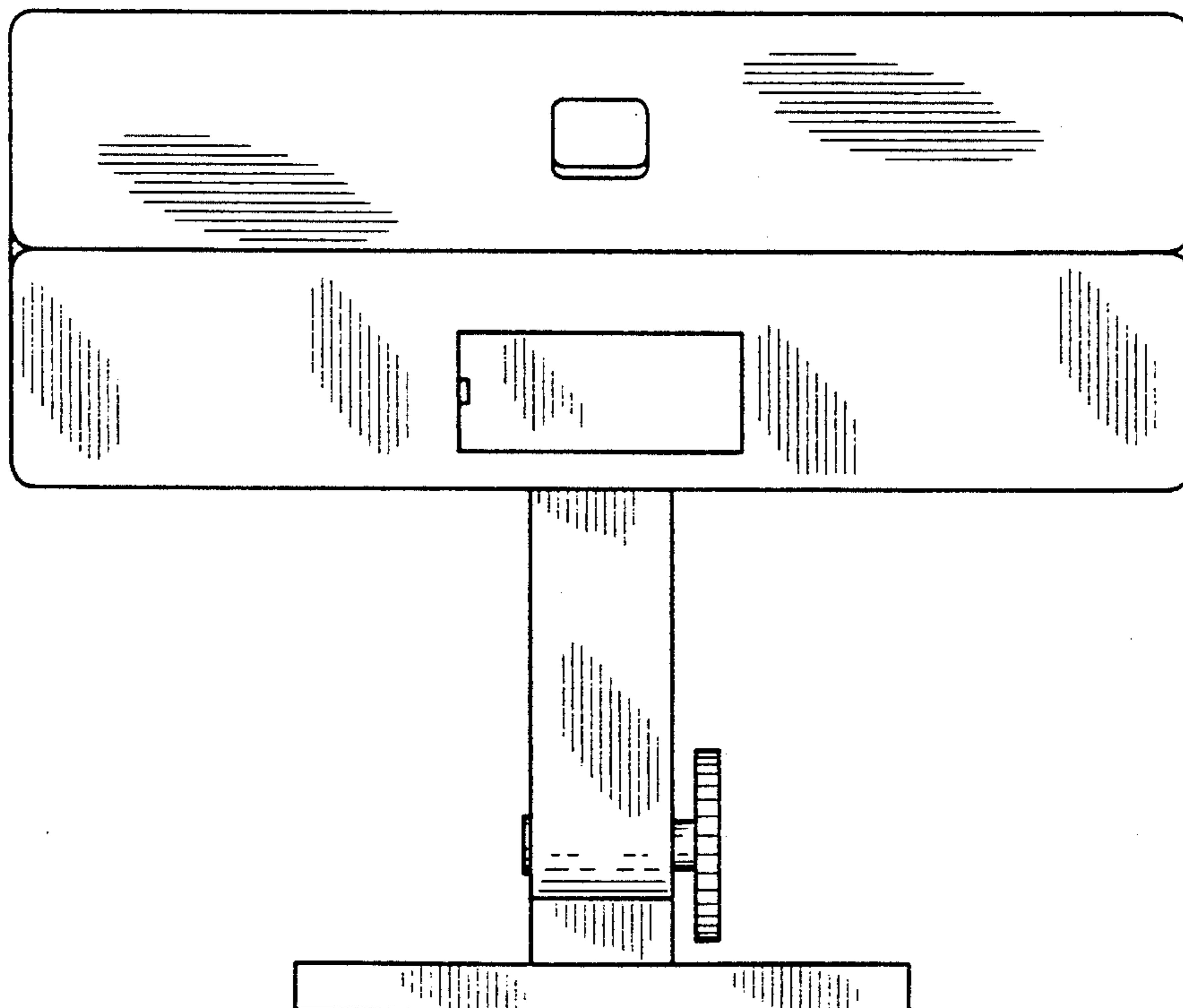

FIG. 3

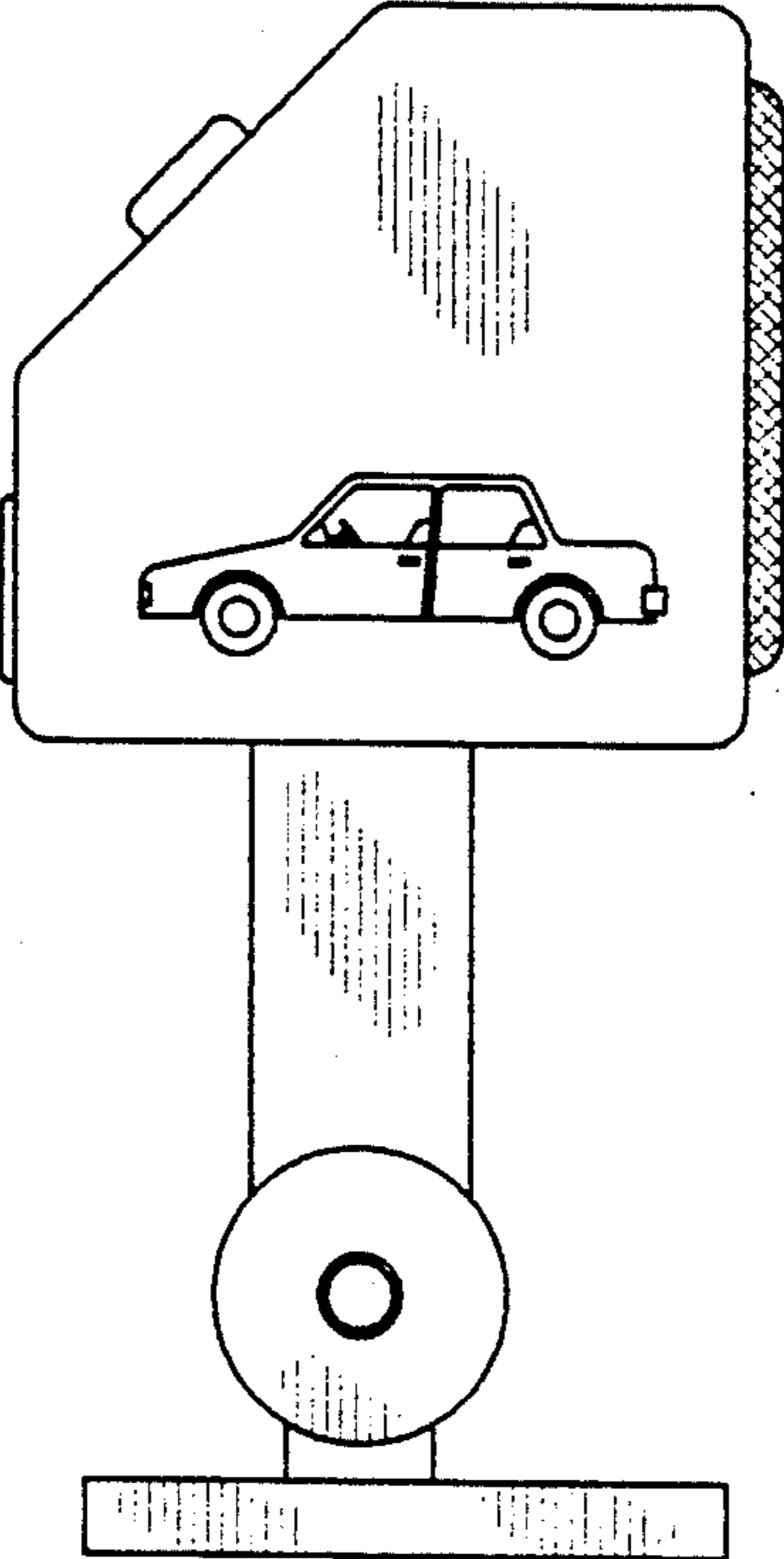

FIG. 4

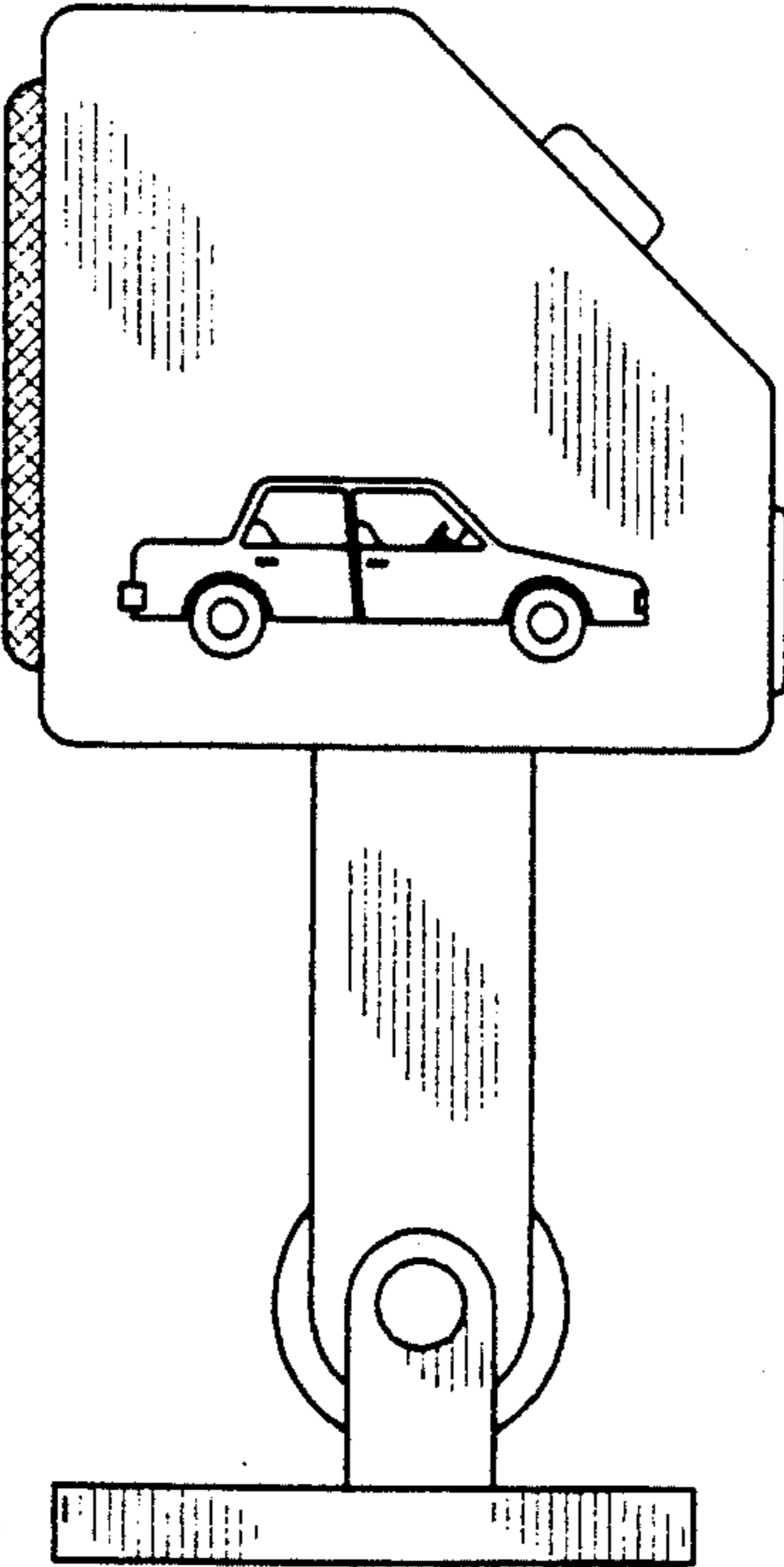

FIG. 5

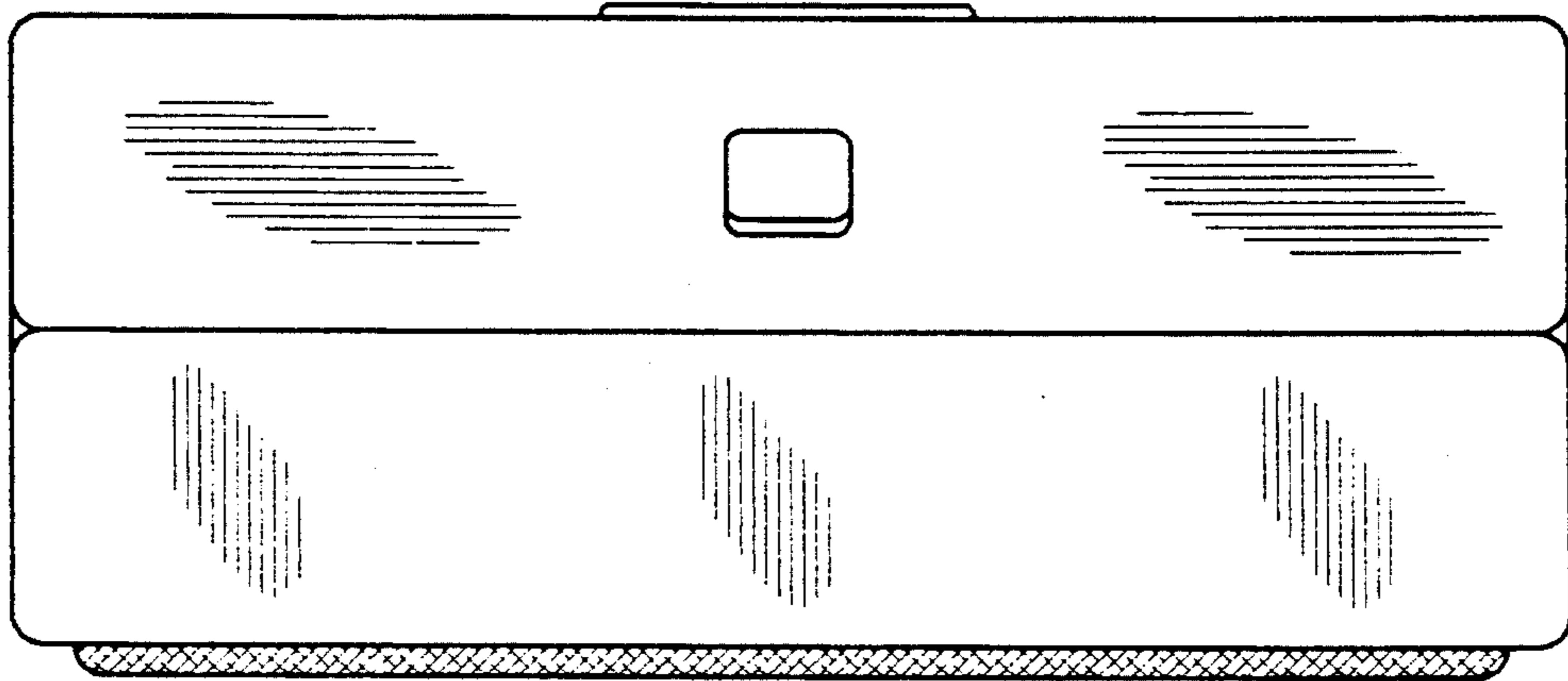

FIG. 6

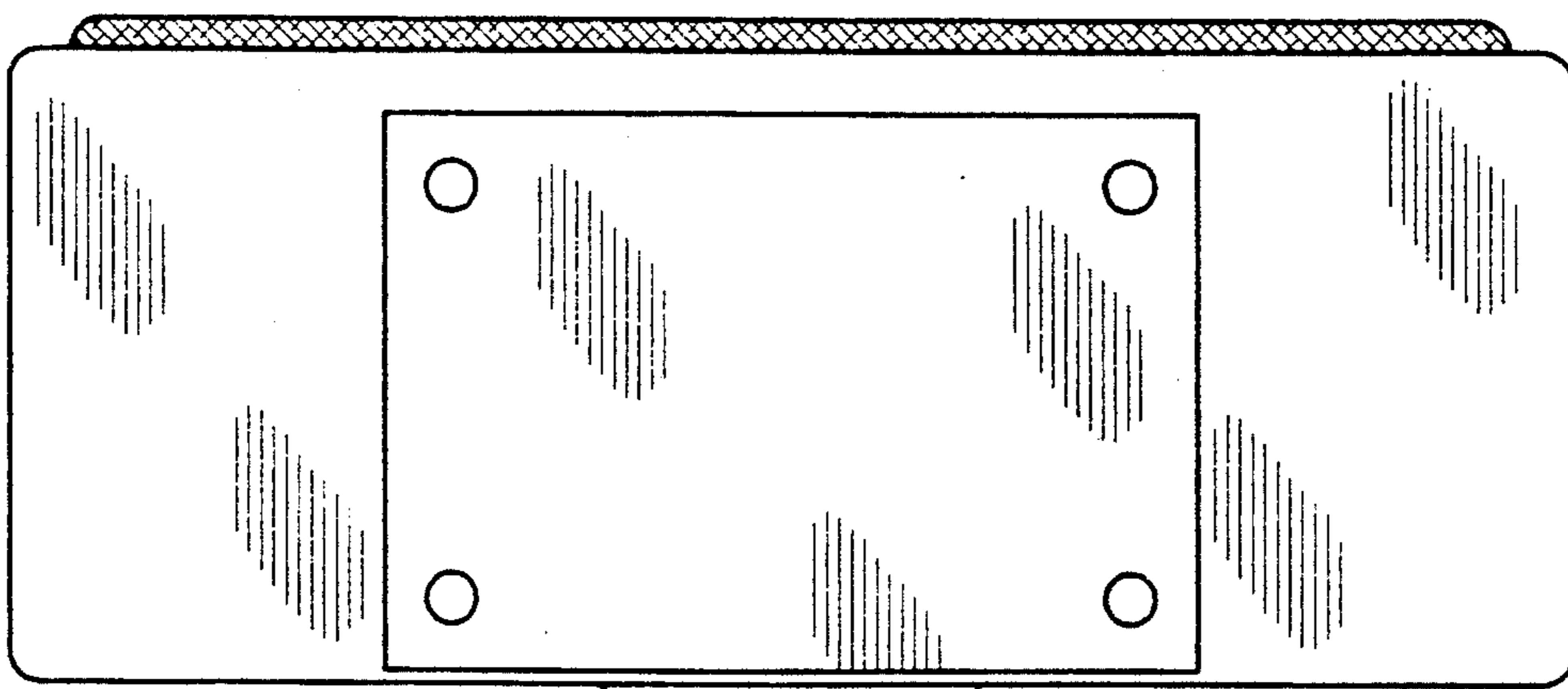

FIG. 7

