



US00D336130S

United States Patent [19]

[11] Patent Number: **Des. 336,130**

Domenici

[45] Date of Patent: **** Jun. 1, 1993**

[54] **PACKAGE FOR DISPOSABLE SANITARY ARTICLE**

4,581,027	4/1986	Alvarado	604/385.1
4,846,828	7/1987	Mendelsohn	604/387
4,857,066	8/1989	Allison	604/386

[76] Inventor: **Robin A. Domenici**, 820 Pleasant St., Southington, Conn. 06489

Primary Examiner—Stella Reid
Attorney, Agent, or Firm—Leon Gilden

[**] Term: **14 Years**

[57] **CLAIM**

[21] Appl. No.: **611,364**

The ornamental design for a package for disposable sanitary article, as shown and described.

[22] Filed: **Nov. 9, 1990**

[52] U.S. Cl. **D24/125**

DESCRIPTION

[58] Field of Search D24/125; 604/385.1, 604/386, 387, 358, 397, 370; D9/346, 414, 416, 432, 433, 341; 206/214, 215, 425, 450, 451

FIG. 1 is a front elevational view of a package for disposable sanitary article, showing my new design in closed condition;

[56] **References Cited**

U.S. PATENT DOCUMENTS

D. 195,430	6/1963	Mapes	D9/416 X
D. 253,873	1/1980	Friedman et al.	D9/415
3,604,423	9/1971	Fraser	D24/125 X
4,085,753	4/1978	Gellert	604/370

FIG. 2 is a rear elevational view thereof;

FIG. 3 is a left side elevational view thereof;

FIG. 4 is a right side elevational view thereof;

FIG. 5 is a top plan view thereof;

FIG. 6 is a bottom plan view thereof; and,

FIG. 7 is a perspective view thereof, with the package in open condition.

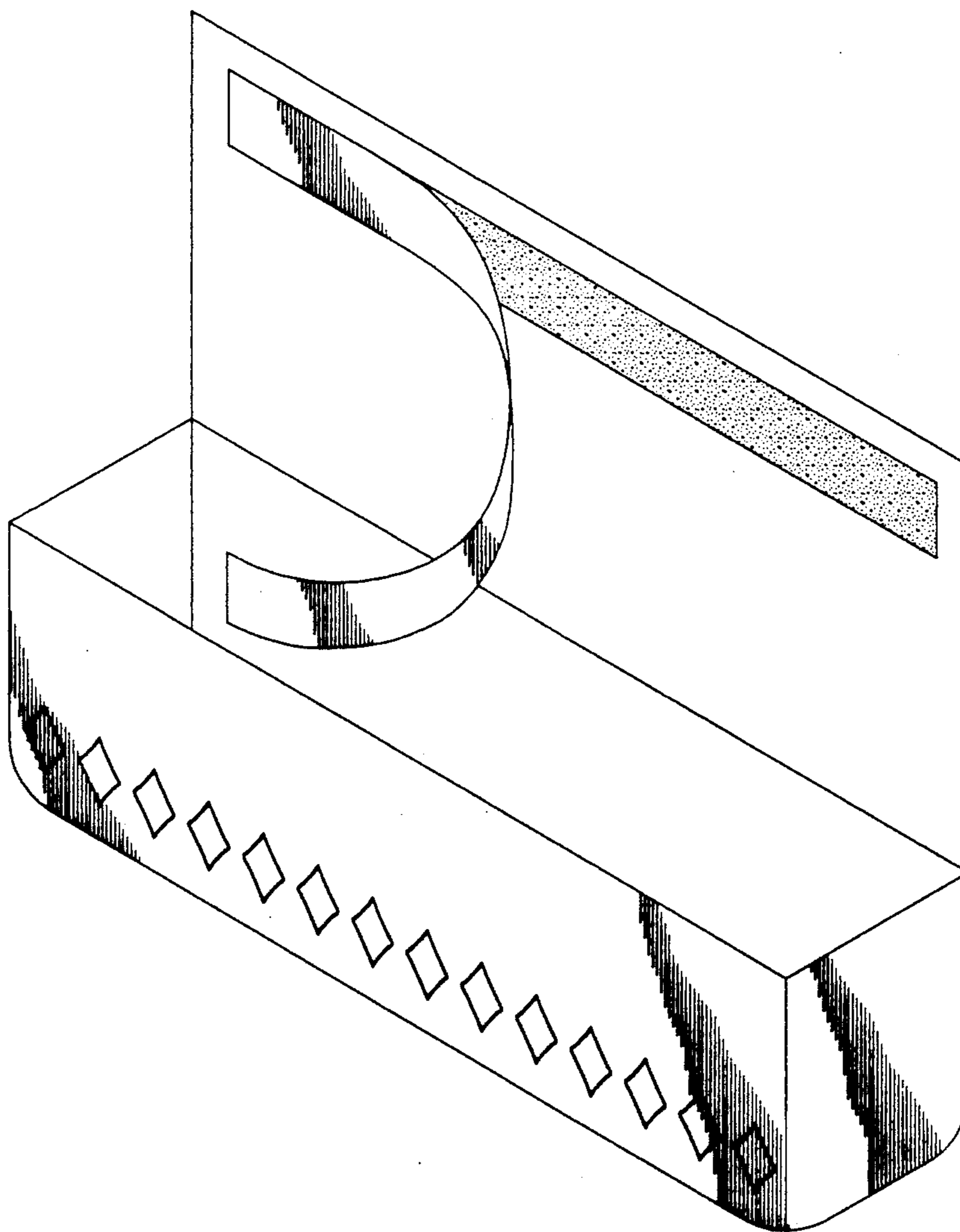

FIG. 1

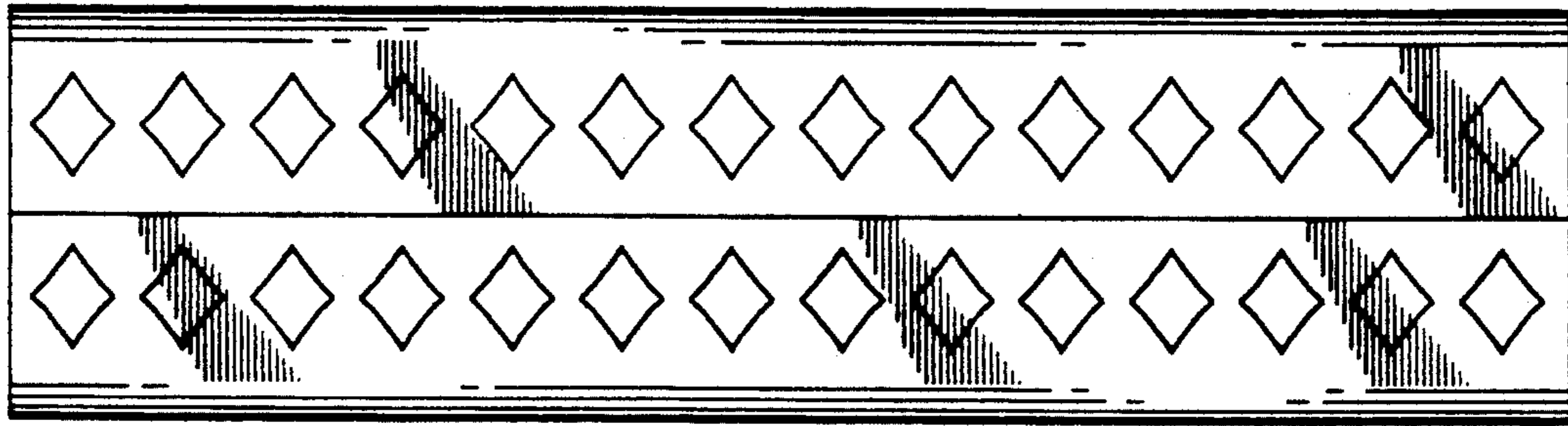

FIG. 2

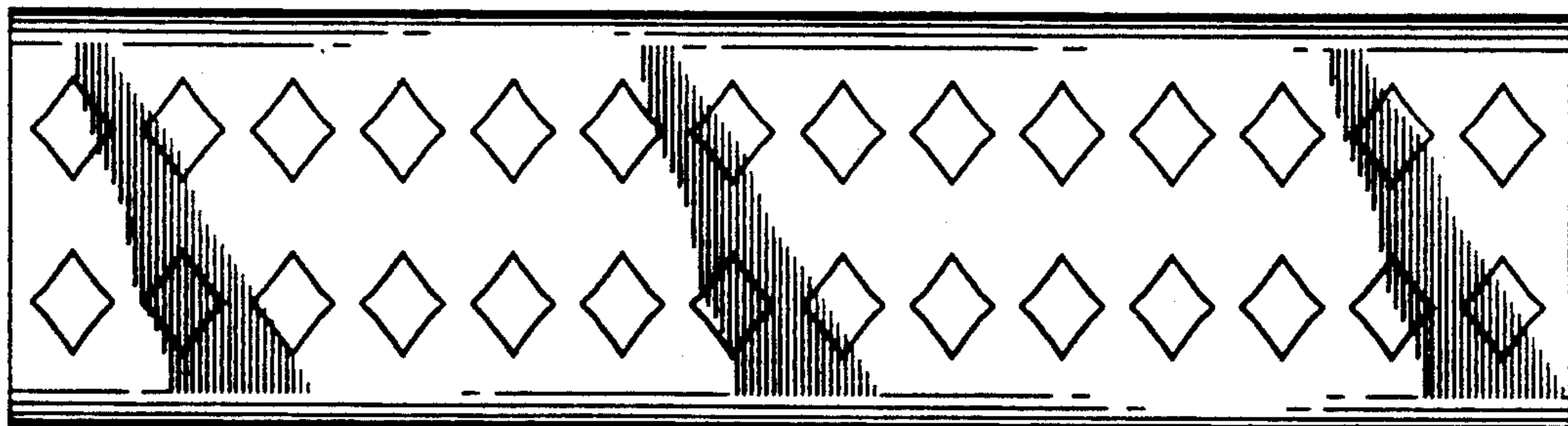

FIG. 3

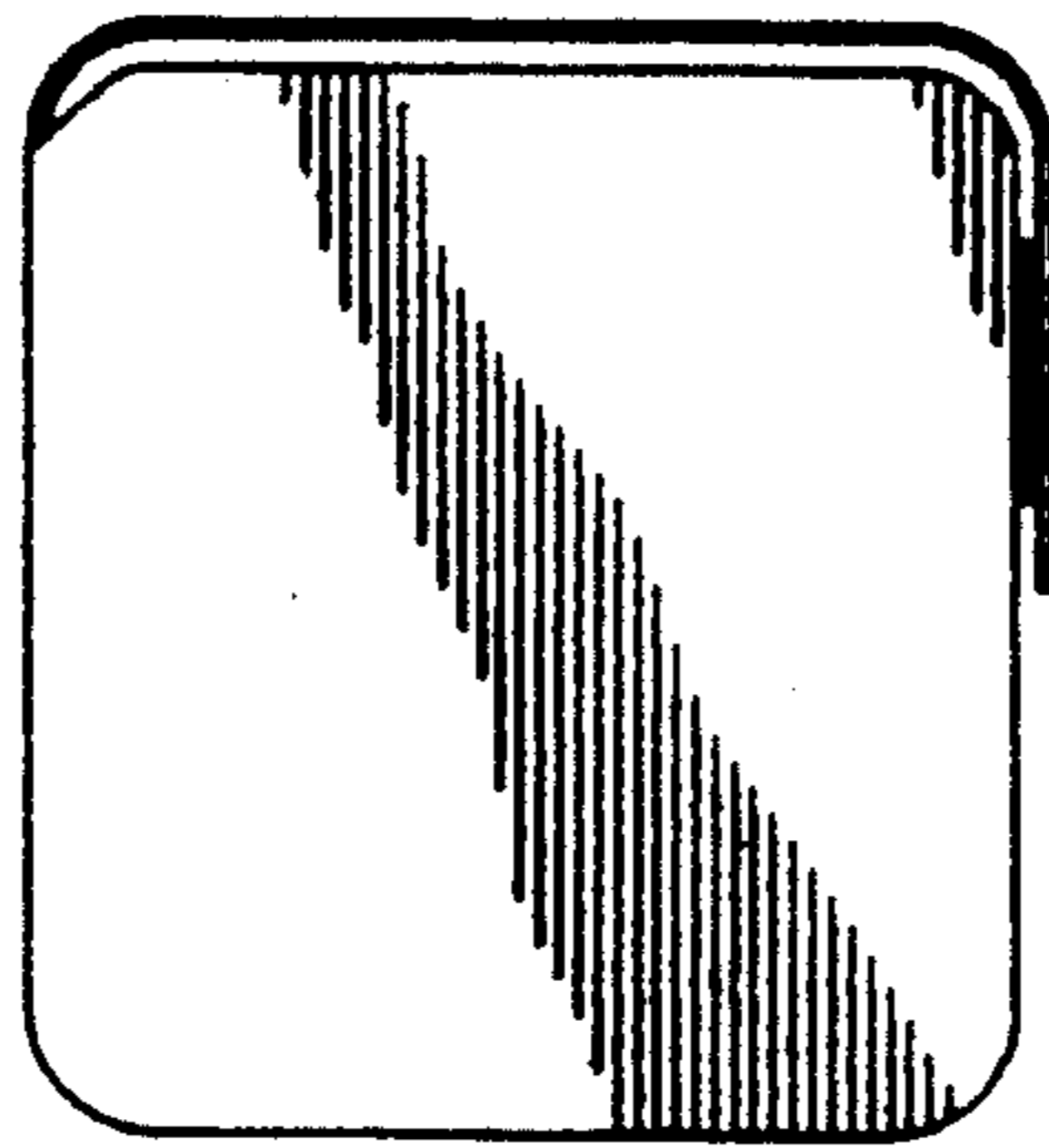

FIG. 4

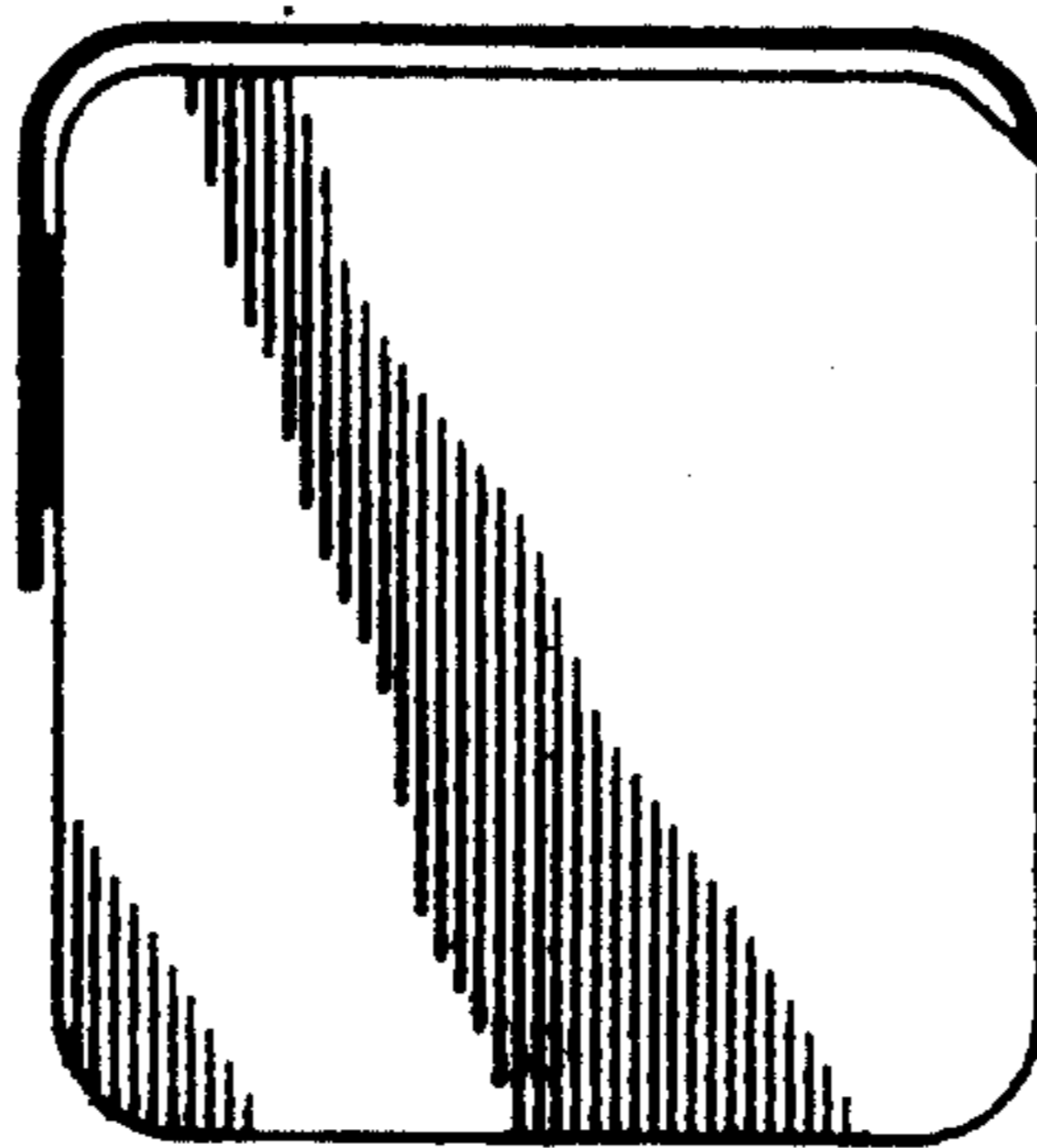

FIG. 5

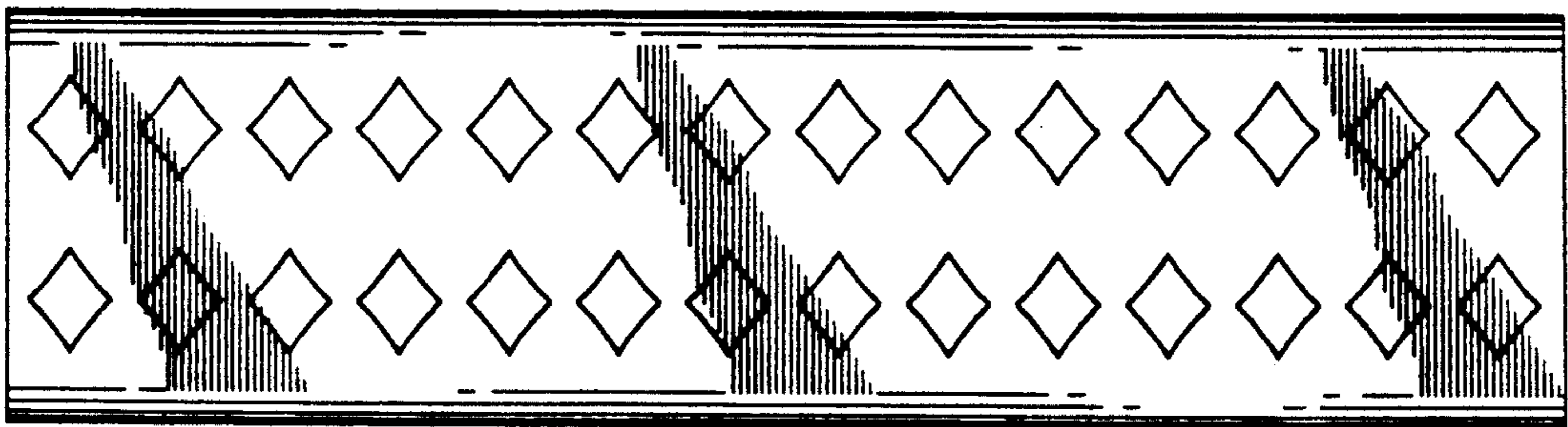

FIG. 6

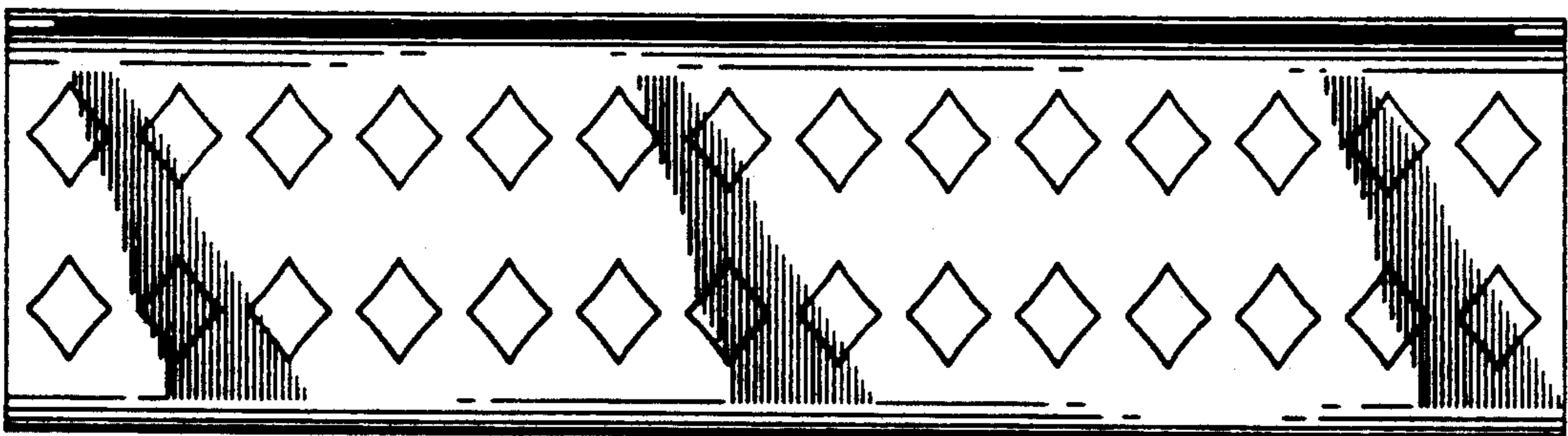

FIG. 7

