



US00D336059S

**United States Patent** [19]

**Chia et al.**

[11] **Patent Number:** Des. 336,059

[45] **Date of Patent:** \*\* Jun. 1, 1993

[54] **JEWELRY LINK**

4,763,489 8/1988 Strong .  
4,781,038 11/1988 Branca et al. .

[76] Inventors: **Meang Chia; Cheo Chia**, both of Chain & Charm Manufacturers, 412 W. 6th St., Suite #1104, Los Angeles, Calif. 90014

*Primary Examiner*—A. Hugo Word  
*Assistant Examiner*—R. Seifert  
*Attorney, Agent, or Firm*—Ladas & Parry

[\*\*] **Term:** 14 Years

[57] **CLAIM**

[21] **Appl. No.:** 503,694

The ornamental design for a jewelry link, as shown and described.

[22] **Filed:** Apr. 3, 1990

[52] **U.S. Cl.** ..... D11/93; D11/6

[58] **Field of Search** ..... D11/1-26,  
D11/93-94, 54, 56, 76, 48; 59/78-90, 92;  
63/1.1-6, 9, 11, 20

**DESCRIPTION**

FIG. 1 is a perspective view of a jewelry link showing my new design;  
FIG. 2 is a top plan view;  
FIG. 3 is a side elevational view;  
FIG. 4 is a bottom plan view;  
FIG. 5 is a top elevational view;  
FIG. 6 is a bottom elevational view;  
FIG. 7 is a perspective view of a jewelry link shown in a position of use, the broken line showing of a hand and adjoining links is for illustrative purposes only and forms no part of the claimed design;  
FIG. 8 is a perspective view of a jewelry link showing a second embodiment of my new design;  
FIG. 9 is a top plan view of FIG. 8;  
FIG. 10 is a side elevational view of FIG. 8;  
FIG. 11 is a bottom plan view of FIG. 8;  
FIG. 12 is a top elevational view of FIG. 8;  
FIG. 13 is a bottom elevational view of FIG. 8;  
FIG. 14 is a perspective view of FIG. 8 shown in a position of use, the broken line showing of a hand and adjoining links is for illustrative purposes only and forms no part of the claimed design;  
FIG. 15 is a perspective view of a jewelry link showing a third embodiment of my new design;  
FIG. 16 is a top plan view of FIG. 15;  
FIG. 17 is a side elevational view of FIG. 15;  
FIG. 18 is a bottom plan view of FIG. 15;  
FIG. 19 is a top elevational view of FIG. 15;  
FIG. 20 is a bottom elevational view of FIG. 15;  
FIG. 21 is a perspective view of FIG. 15 shown in a position of use, the broken line showing of a hand and adjoining links is for illustrative purposes only and forms no part of the claimed design;

[56] **References Cited**

**U.S. PATENT DOCUMENTS**

- |            |         |                    |        |
|------------|---------|--------------------|--------|
| 32,439     | 4/1900  | Gay .....          | D11/12 |
| 42,643     | 6/1912  | Meyers .....       | D11/92 |
| 48,950     | 4/1916  | Rosenberger .      |        |
| D. 56,605  | 11/1920 | Grasmuk .          |        |
| 56,607     | 11/1920 | Grasmuk .          |        |
| D. 84,213  | 5/1931  | Speidel .          |        |
| 110,568    | 7/1938  | Garfinkel .        |        |
| 117,577    | 11/1939 | Sand .             |        |
| D. 131,750 | 2/1942  | Hobe .             |        |
| 131,847    | 3/1942  | Hobe .             |        |
| D. 143,588 | 1/1946  | Grun .             |        |
| D. 144,901 | 6/1946  | Braunstein .       |        |
| D. 145,426 | 8/1946  | Braunstein .       |        |
| 146,779    | 5/1947  | Slater .           |        |
| D. 151,904 | 11/1948 | Katz .             |        |
| D. 156,650 | 12/1949 | Pearce et al. .... | D11/12 |
| D. 156,744 | 3/1949  | Kent .             |        |
| D. 160,241 | 9/1950  | Bardach .          |        |
| D. 176,664 | 1/1956  | Katz .             |        |
| 186,903    | 12/1959 | Hess .             |        |
| 202,723    | 11/1965 | Gaston .           |        |
| D. 257,017 | 9/1980  | Barr .....         | D11/17 |
| D. 265,639 | 8/1982  | Barr .             |        |
| D. 325,180 | 4/1992  | Chia et al. ....   | D11/93 |
| 1,153,362  | 9/1915  | Wacha .....        | 59/82  |
| 1,189,497  | 7/1916  | Schwartzman .      |        |
| 1,344,365  | 6/1920  | Wachenheimer .     |        |
| 1,589,423  | 6/1926  | Payton .           |        |
| 1,981,696  | 11/1934 | Harper .....       | D11/93 |
| 2,538,090  | 7/1947  | Ferragamo .        |        |
| 2,852,923  | 1/1958  | Gamelsky .         |        |

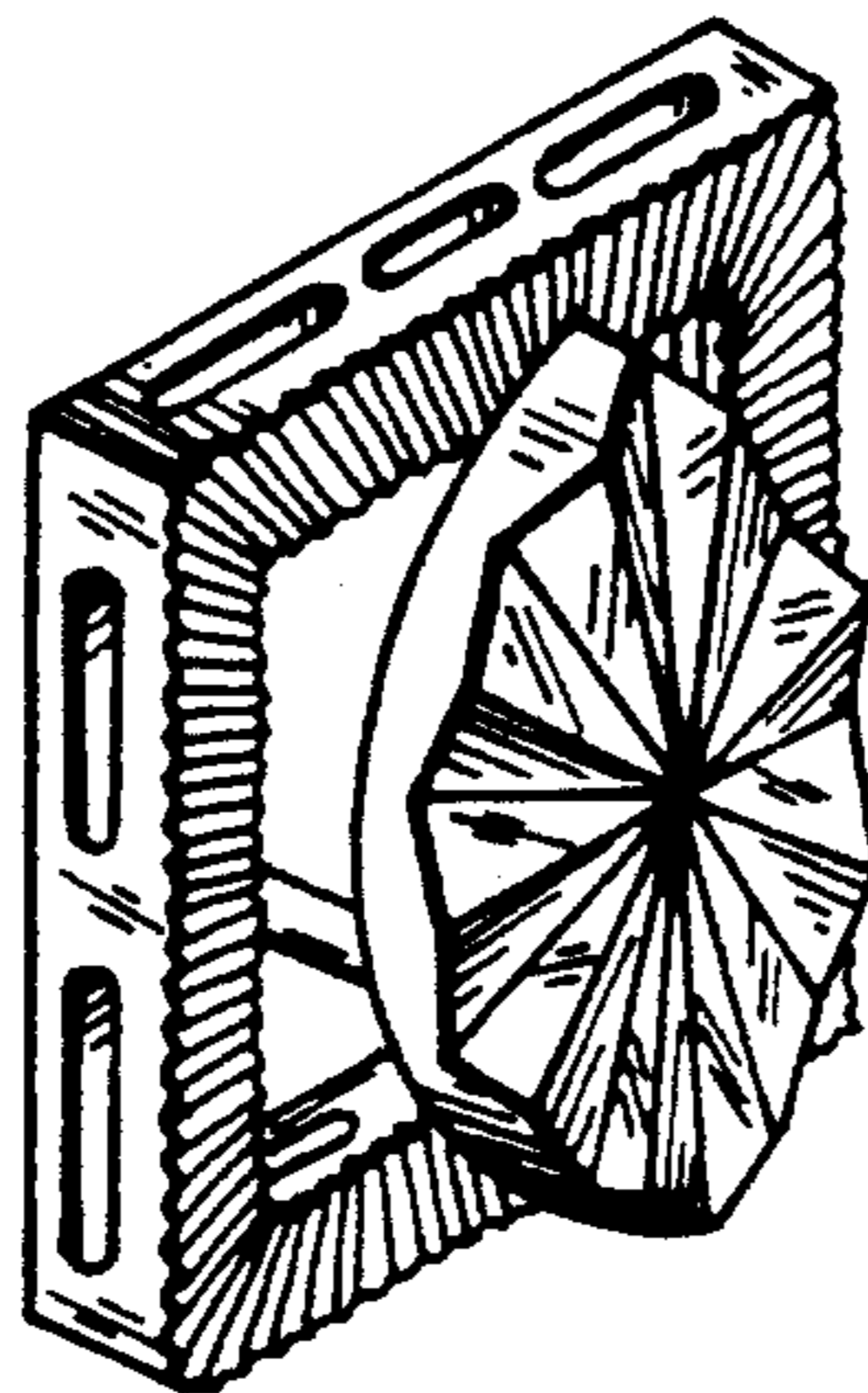

FIG. 22 is a perspective view of a jewelry link showing a fourth embodiment of my new design;  
FIG. 23 is a top plan view of FIG. 22;  
FIG. 24 is a side elevational view of FIG. 22;  
FIG. 25 is a bottom plan view of FIG. 22;  
FIG. 26 is a top elevational view of FIG. 22;  
FIG. 27 is a bottom elevational view of FIG. 22;  
FIG. 28 is a perspective view of FIG. 22 shown in a position of use, the broken line showing of a hand and adjoining links is for illustrative purposes only and forms no part of the claimed design;  
FIG. 29 is a perspective view of a jewelry link showing a fifth embodiment of my new design;  
FIG. 30 is a top plan view of FIG. 29;  
FIG. 31 is a side elevational view of FIG. 29;  
FIG. 32 is a bottom plan view of FIG. 29;

FIG. 33 is a top elevational view of FIG. 29;  
FIG. 34 is a bottom elevational view of FIG. 29;  
FIG. 35 is a perspective view of FIG. 29 shown in a position of use, the broken line showing of a hand and adjoining links is for illustrative purposes only and forms no part of the claimed design;  
FIG. 36 is a perspective view of a jewelry link showing a sixth embodiment of my new design;  
FIG. 37 is a top plan view of FIG. 36;  
FIG. 38 is a side elevational view of FIG. 36;  
FIG. 39 is a bottom plan view of FIG. 36;  
FIG. 40 is a top elevational view of FIG. 36;  
FIG. 41 is a bottom elevational view of FIG. 36; and,  
FIG. 42 is a perspective view of FIG. 36 shown in a position of use, the broken line showing of a hand and adjoining links is for illustrative purposes only and forms no part of the claimed design.

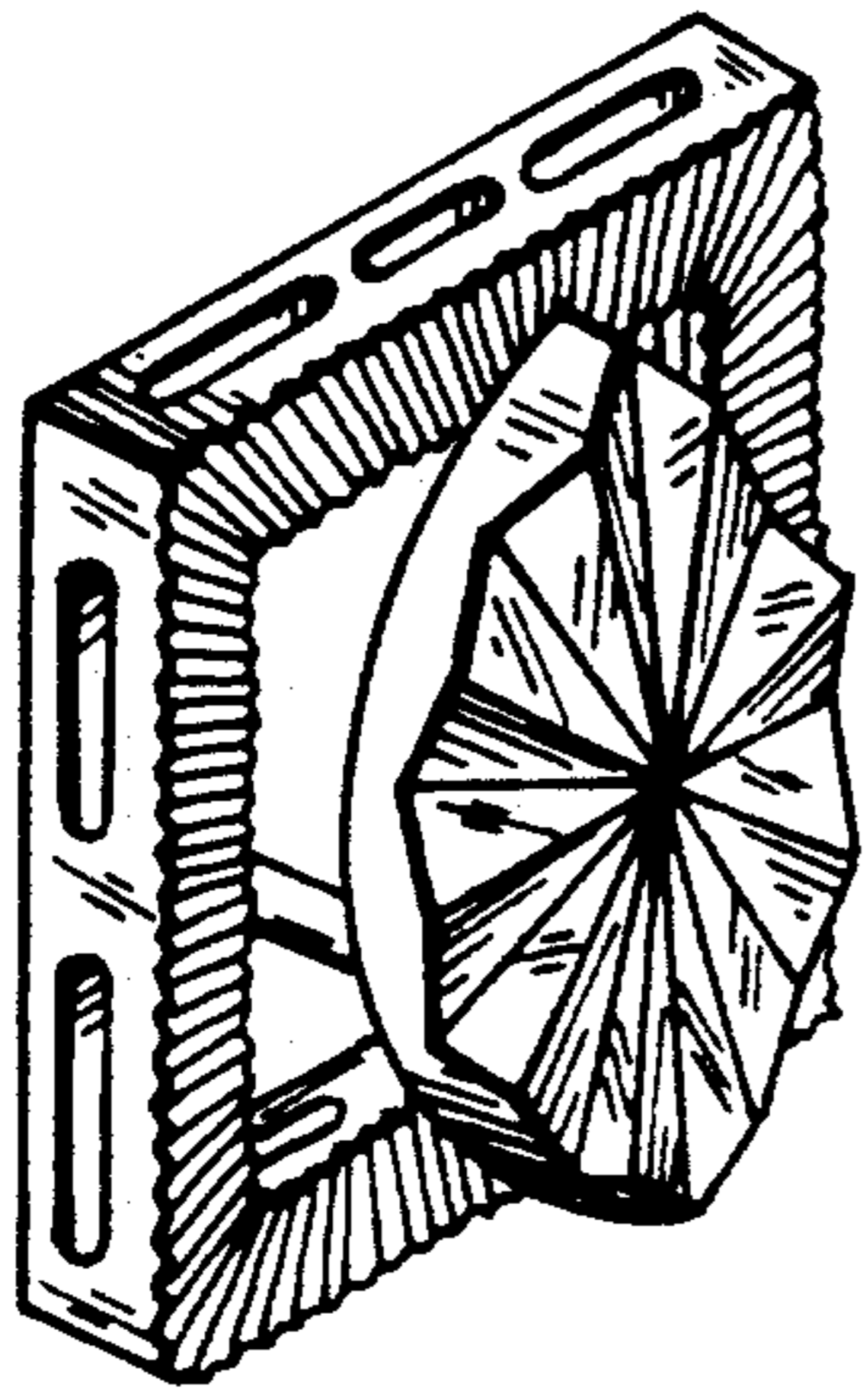

FIG. 1

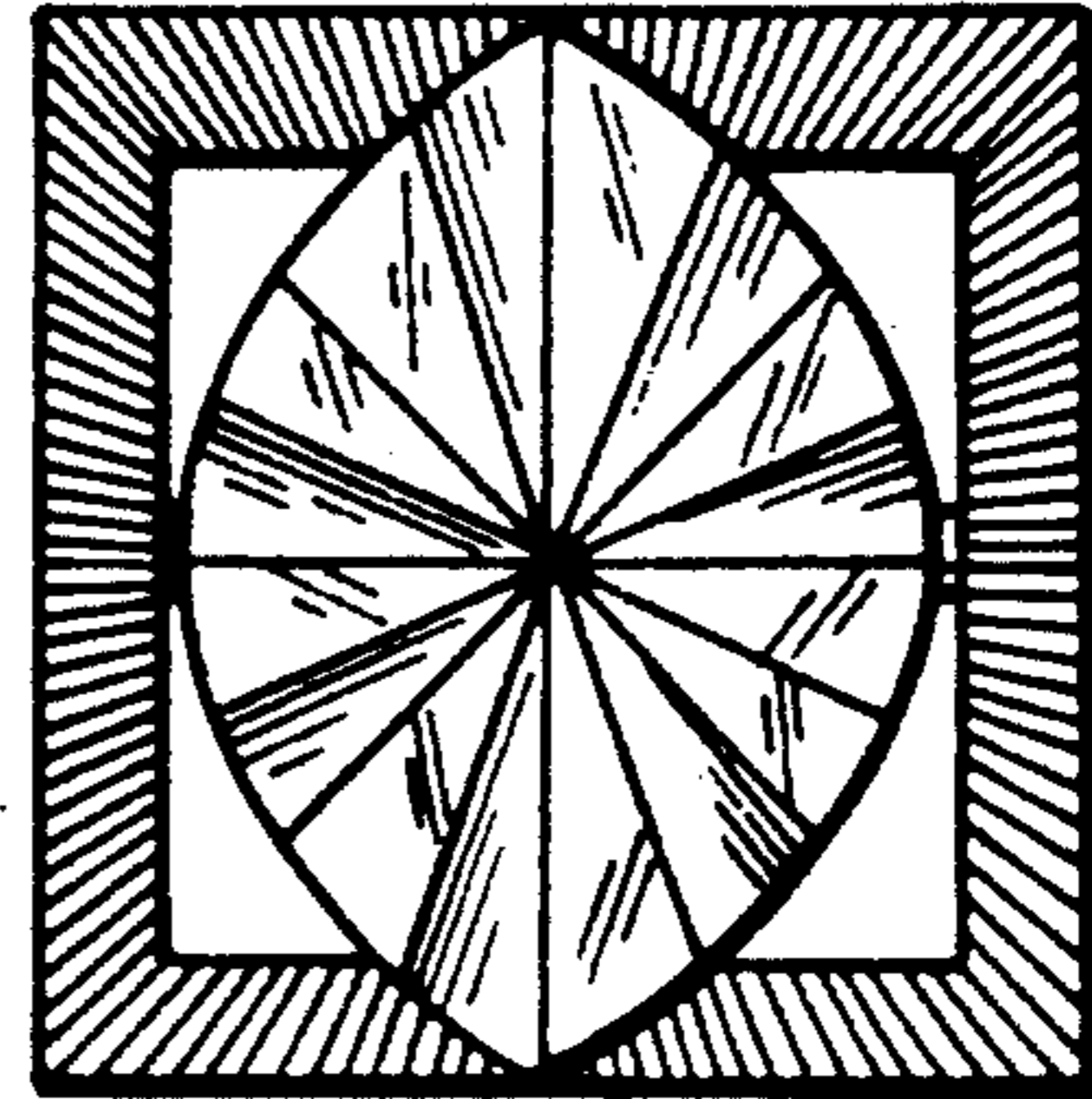

FIG. 2

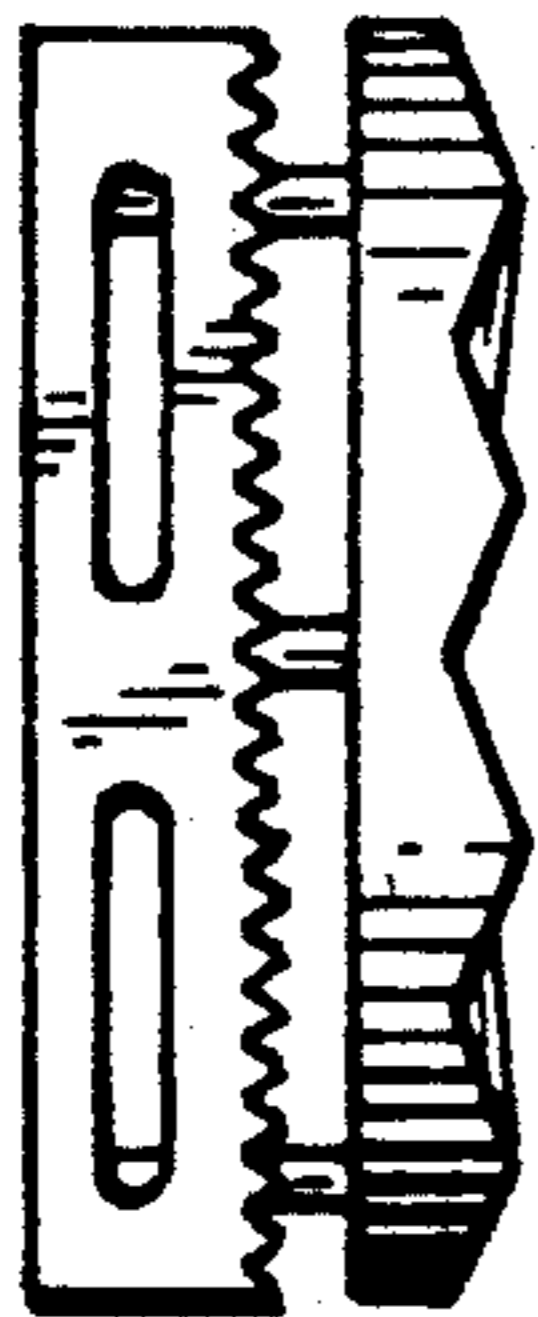

FIG. 3

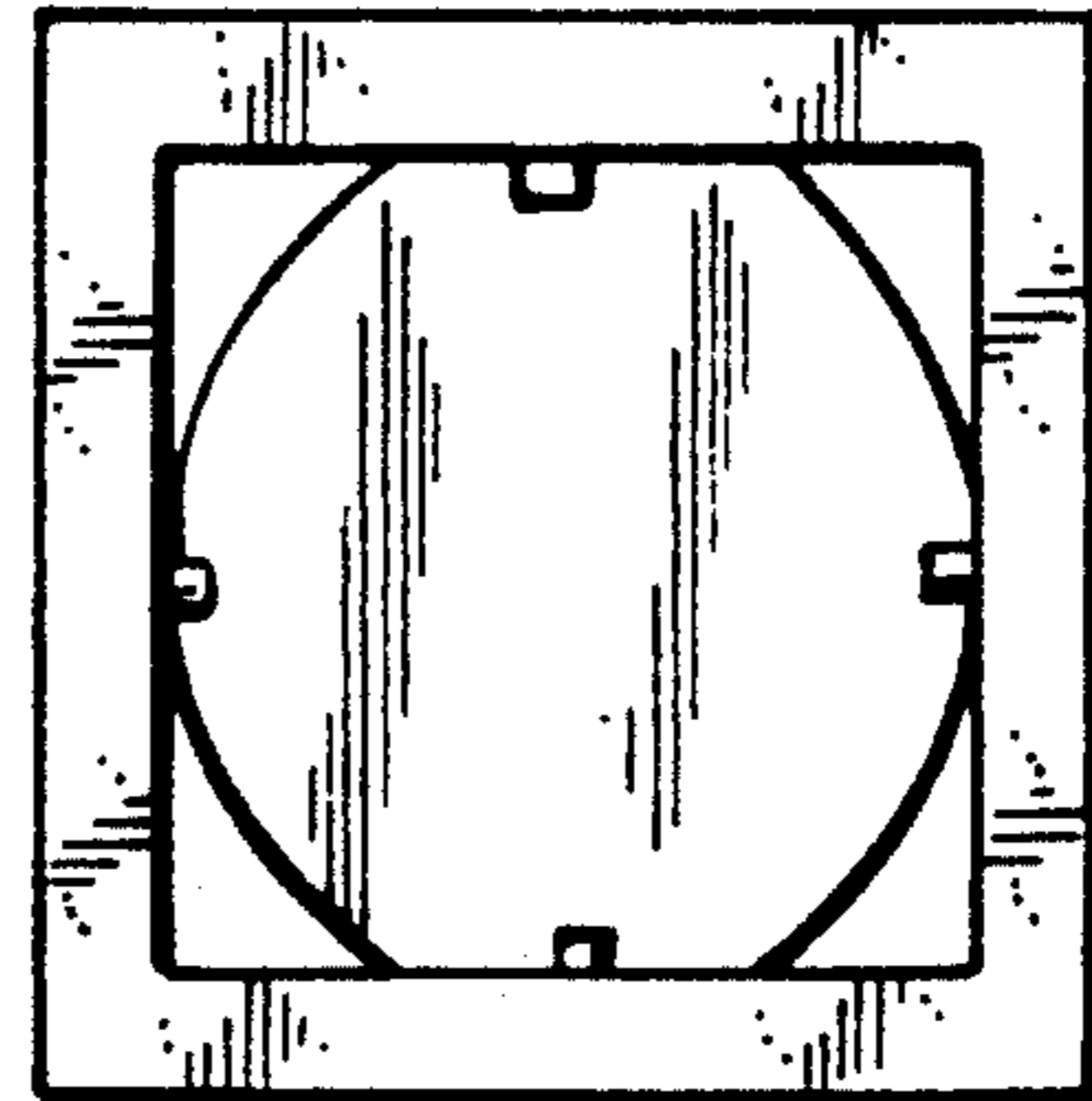

FIG. 4

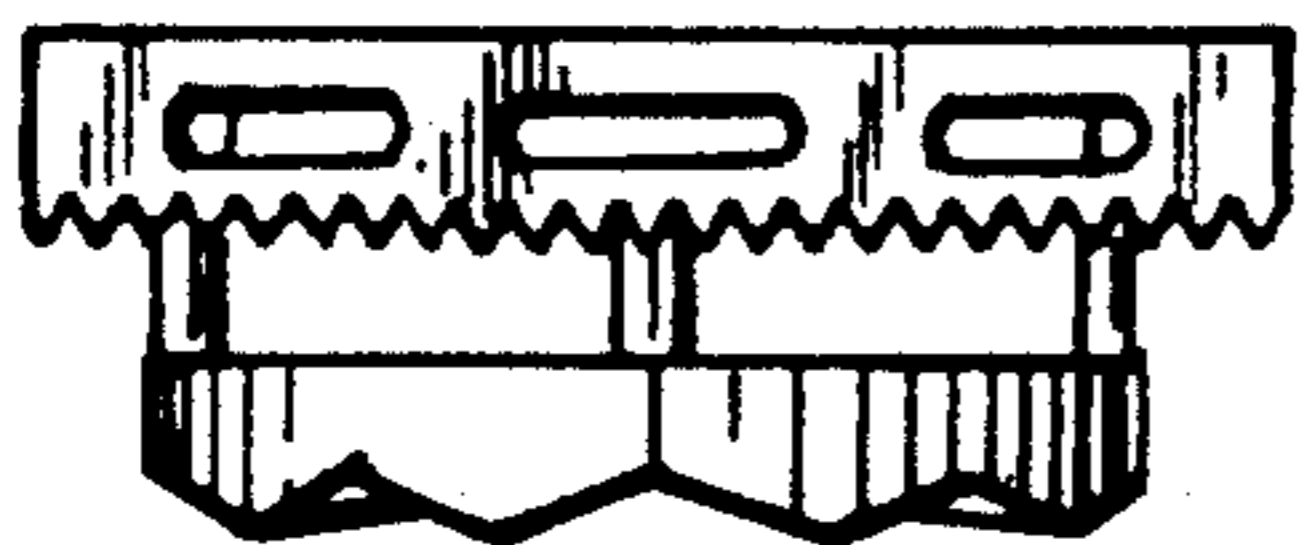

FIG. 5



FIG. 6

FIG. 7

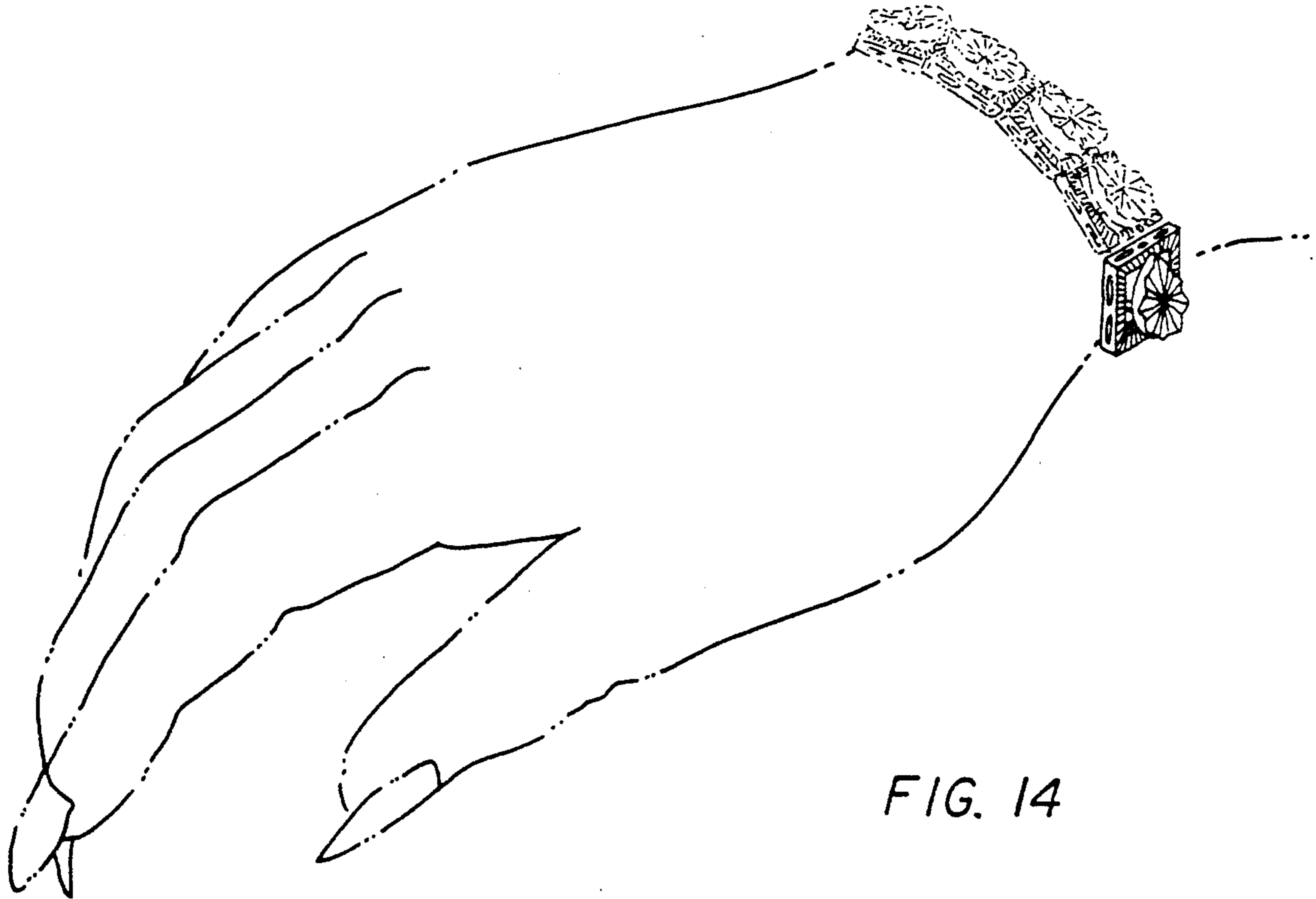
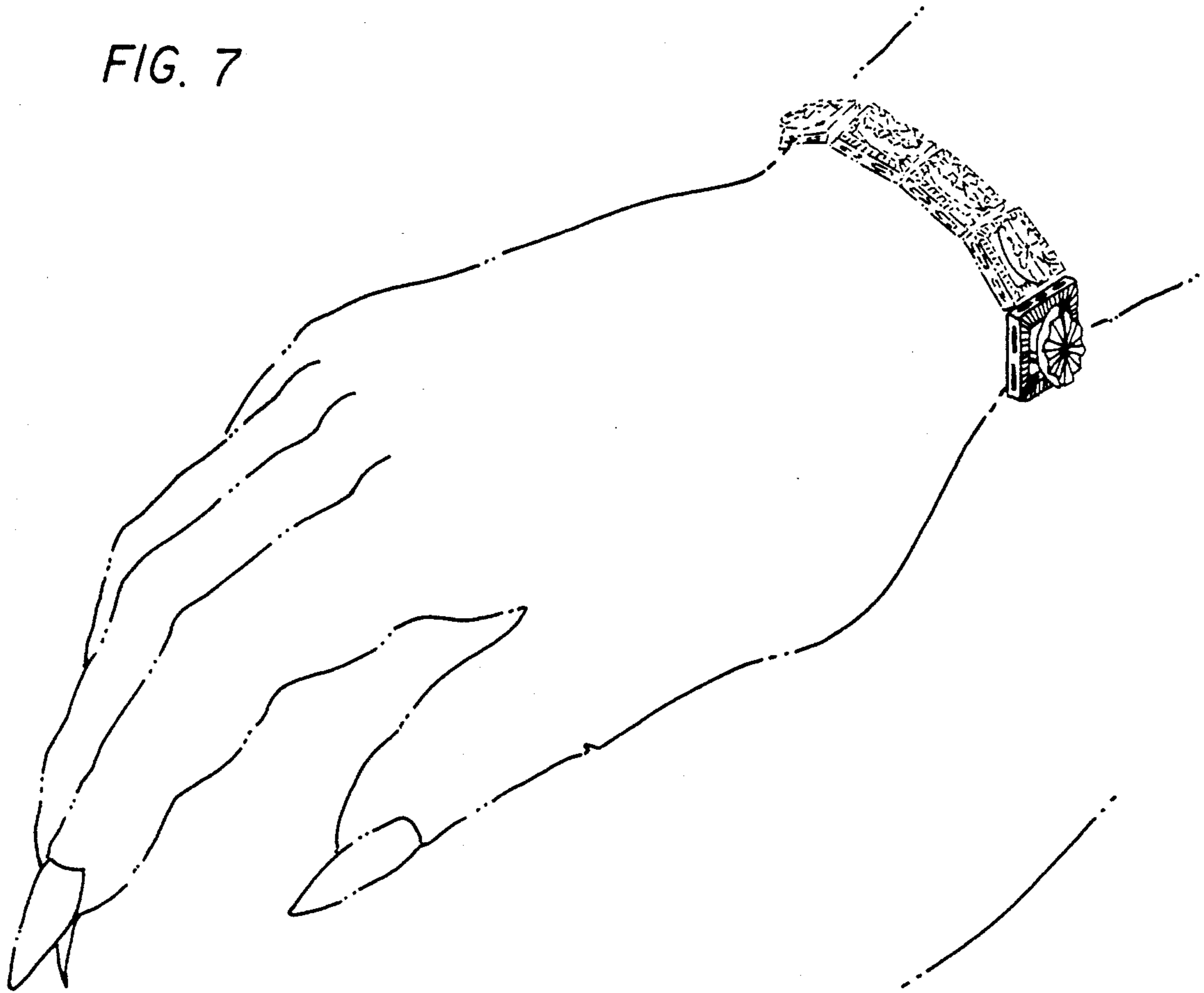
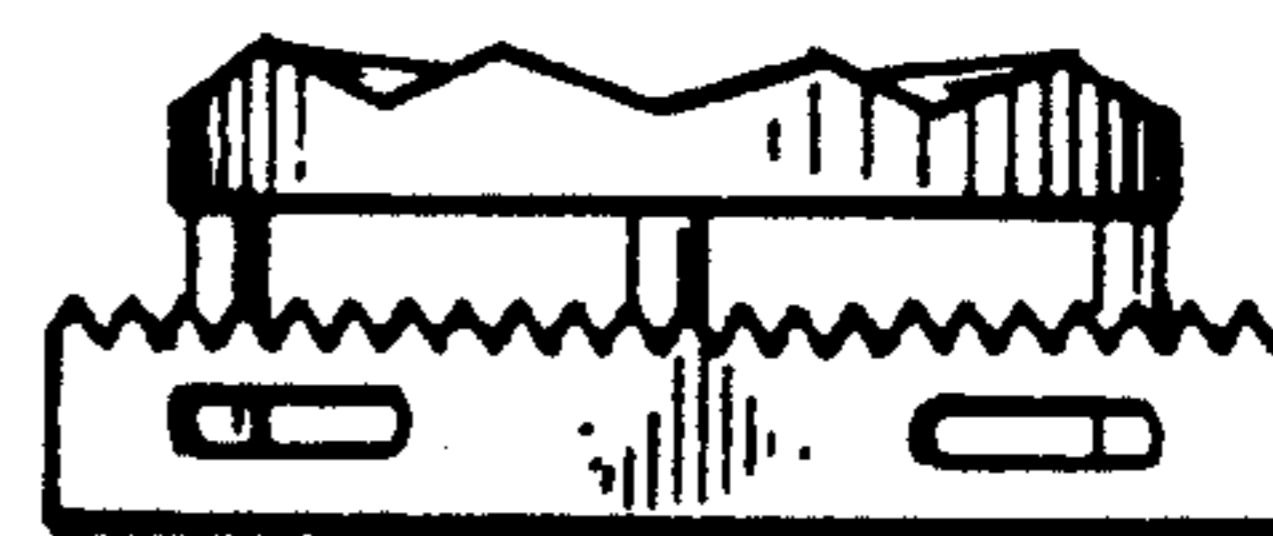
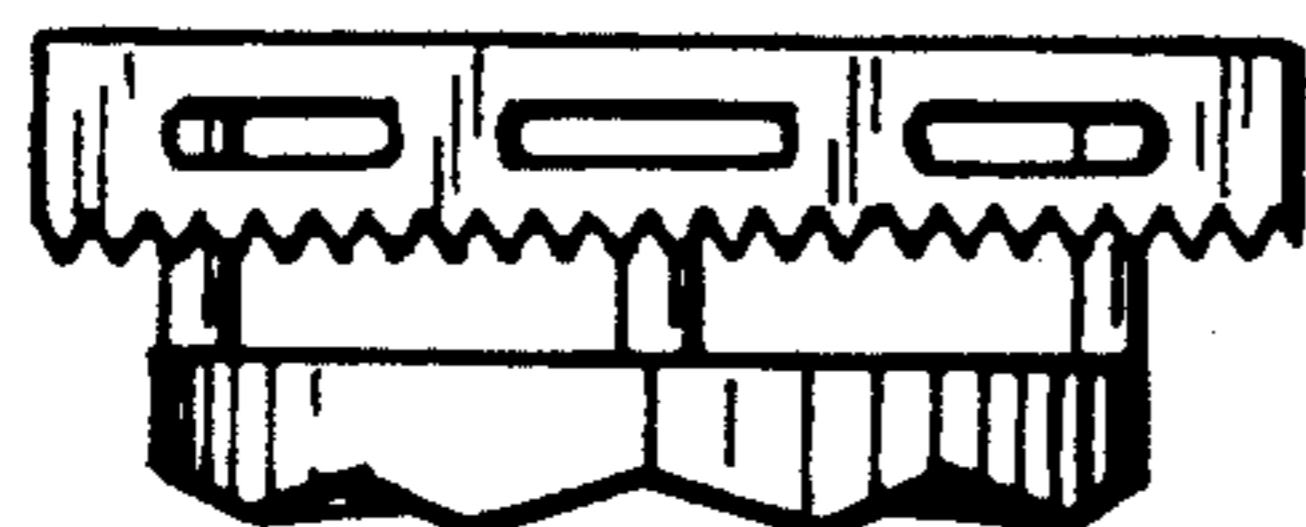
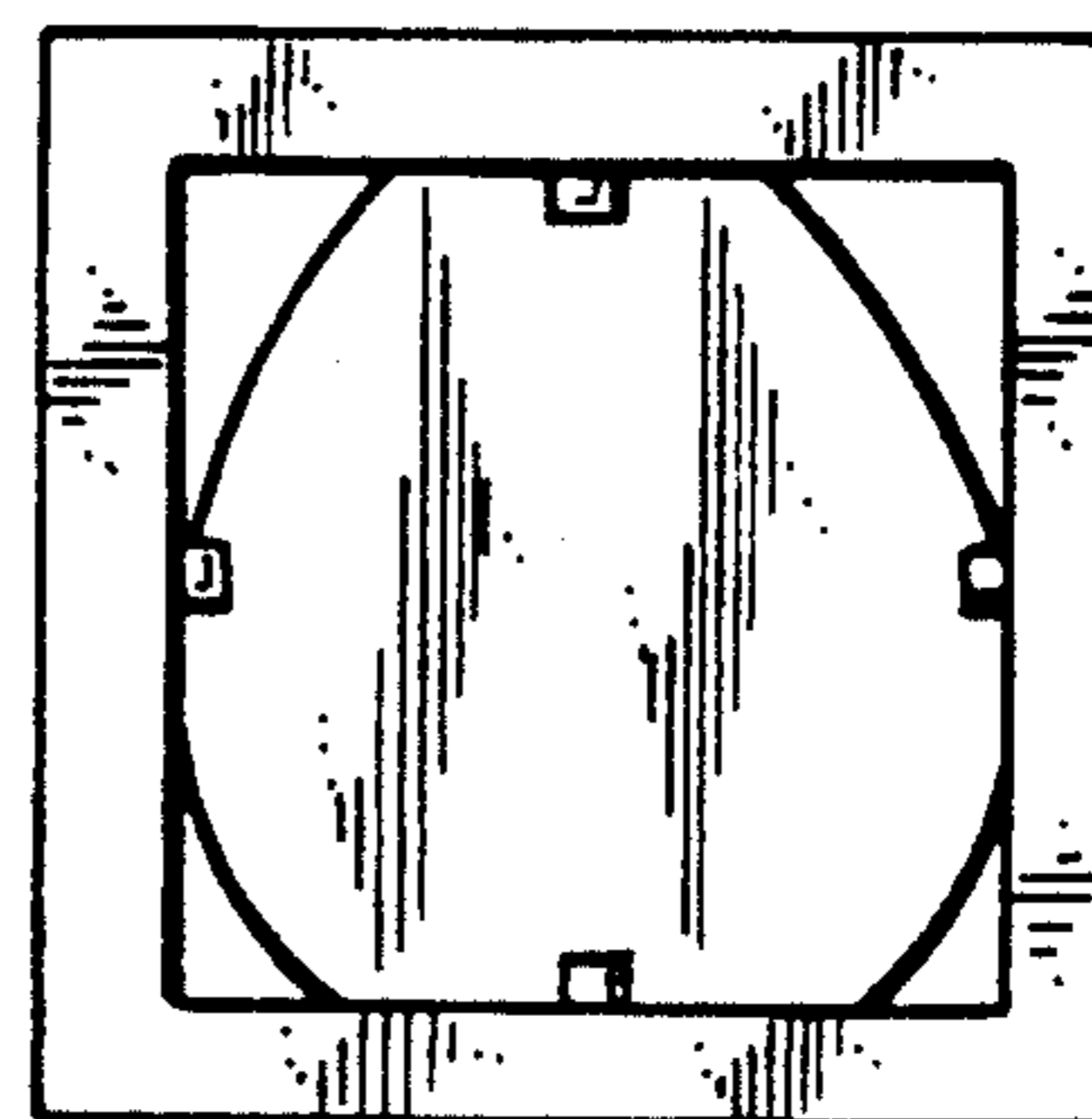
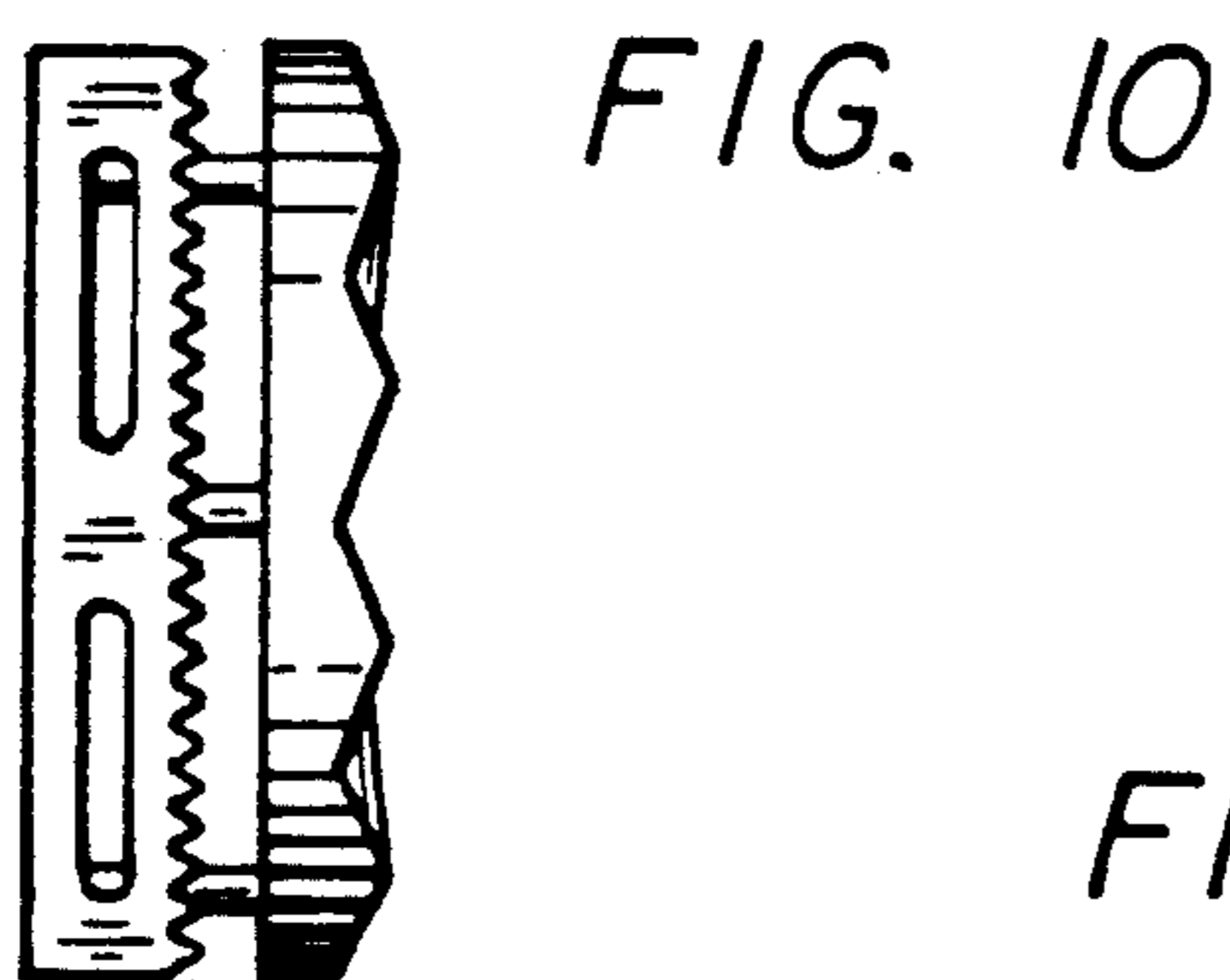
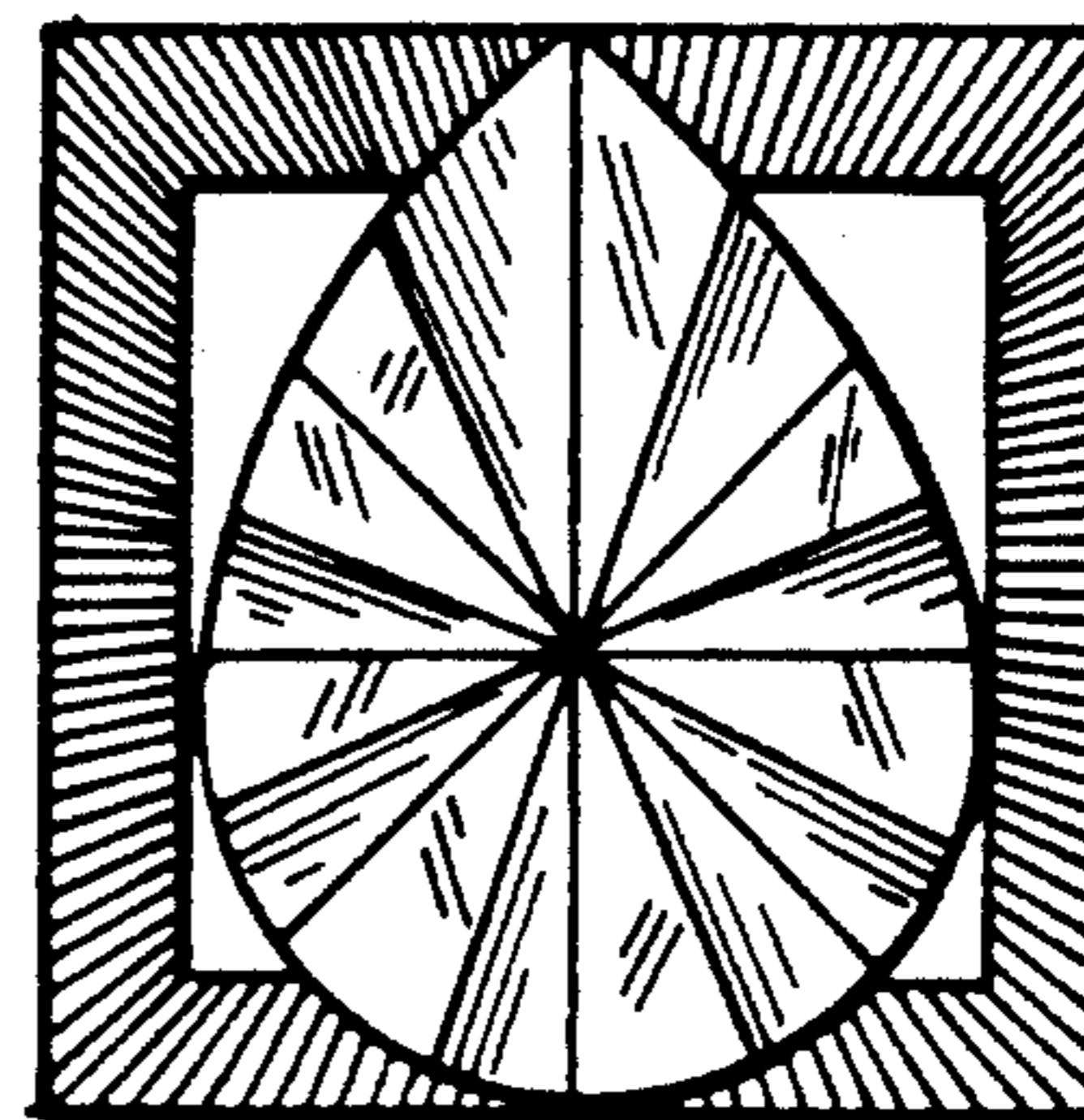
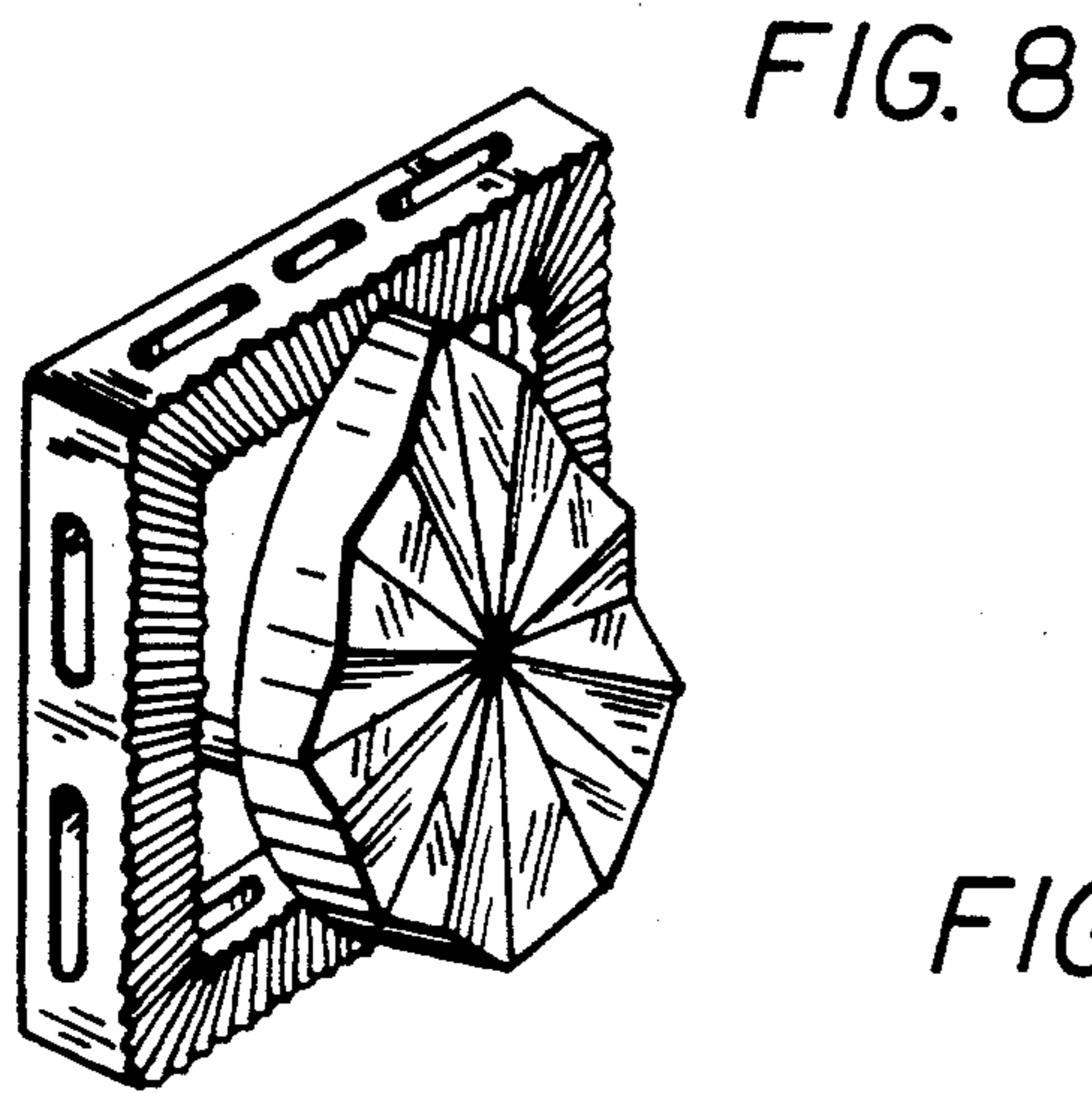

FIG. 14



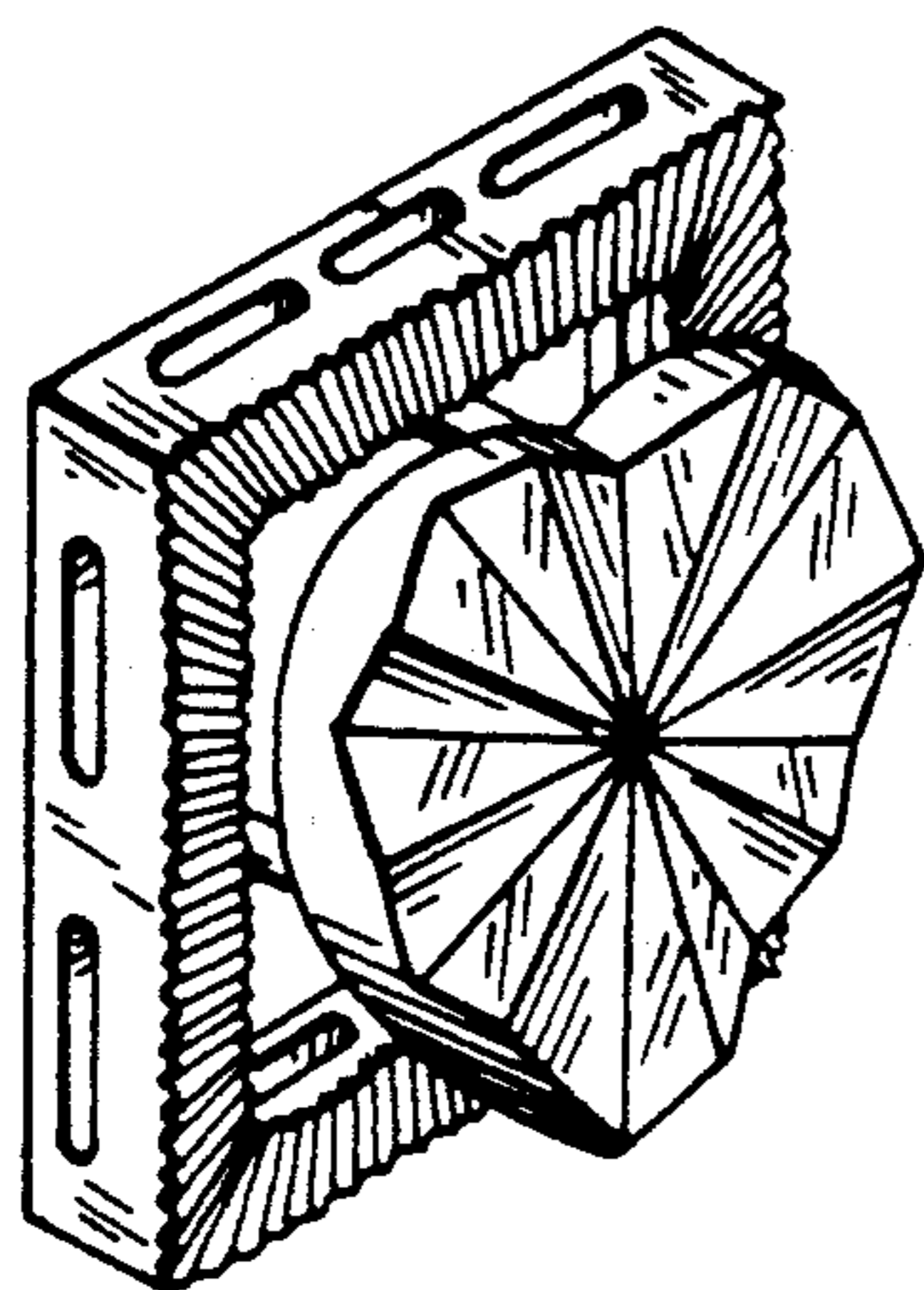

FIG. 15

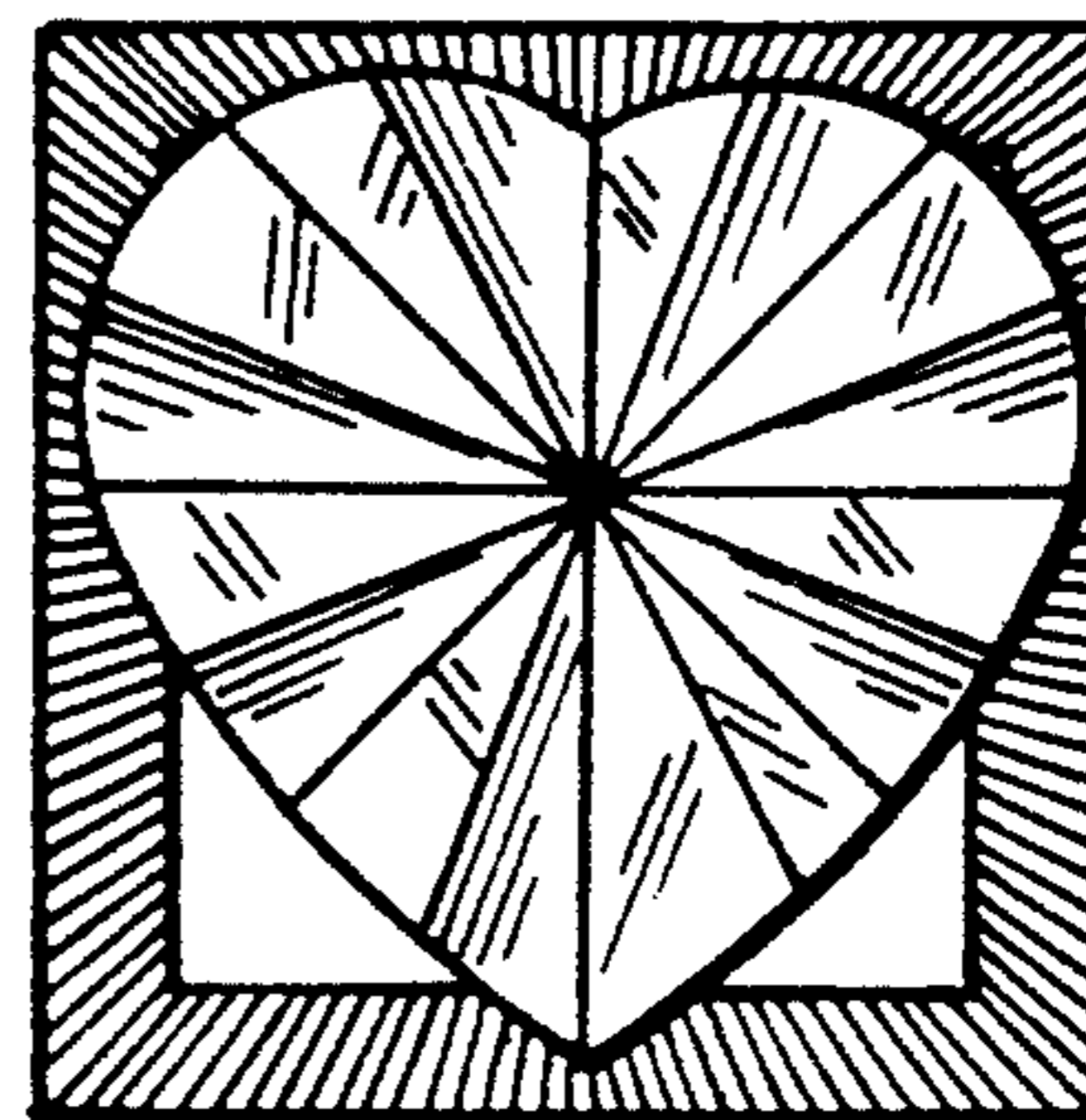

FIG. 16

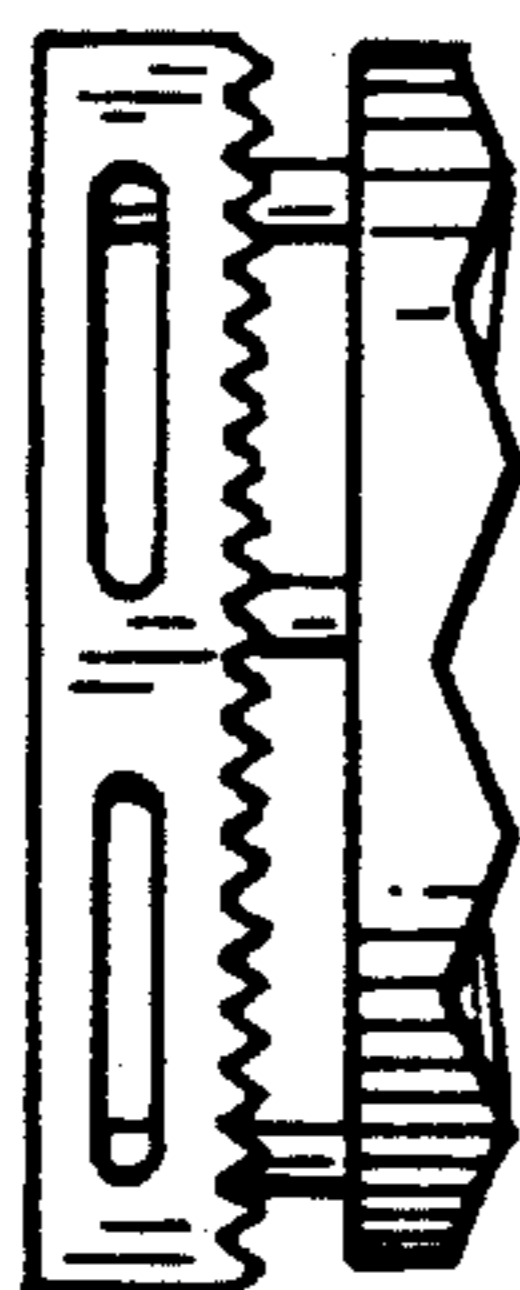

FIG. 17

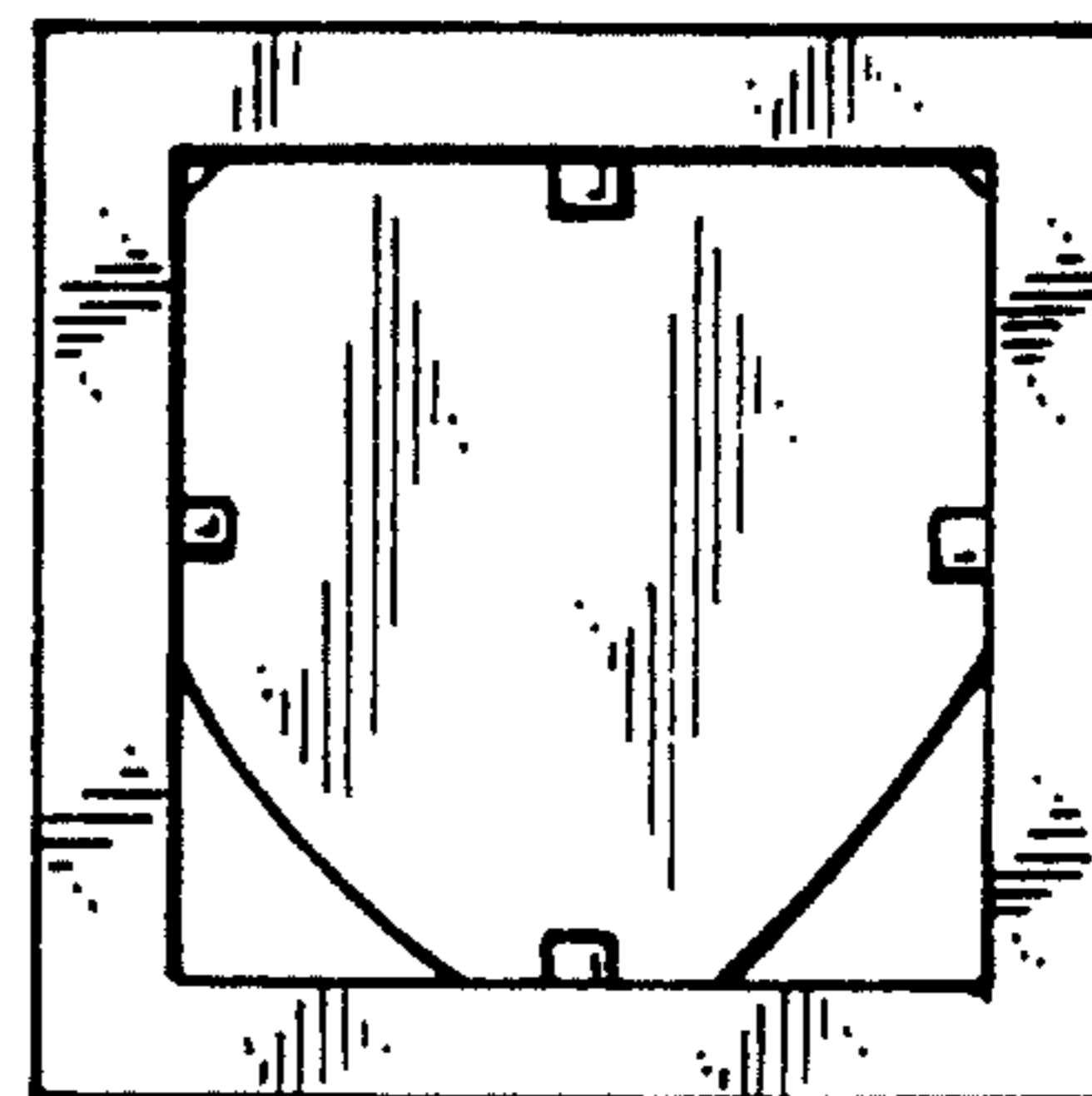

FIG. 18

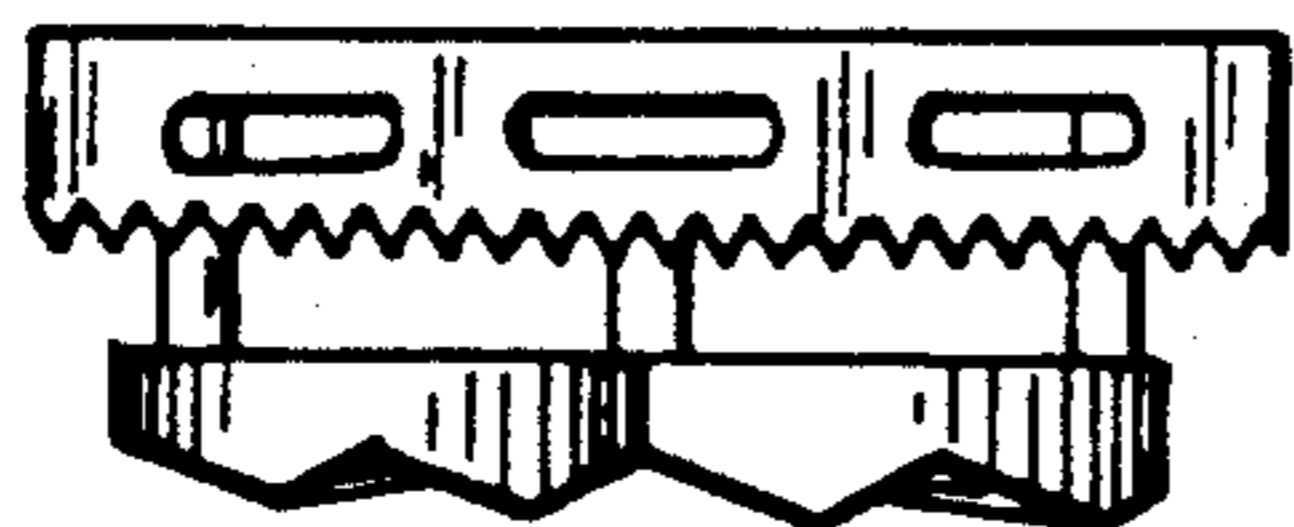

FIG. 19

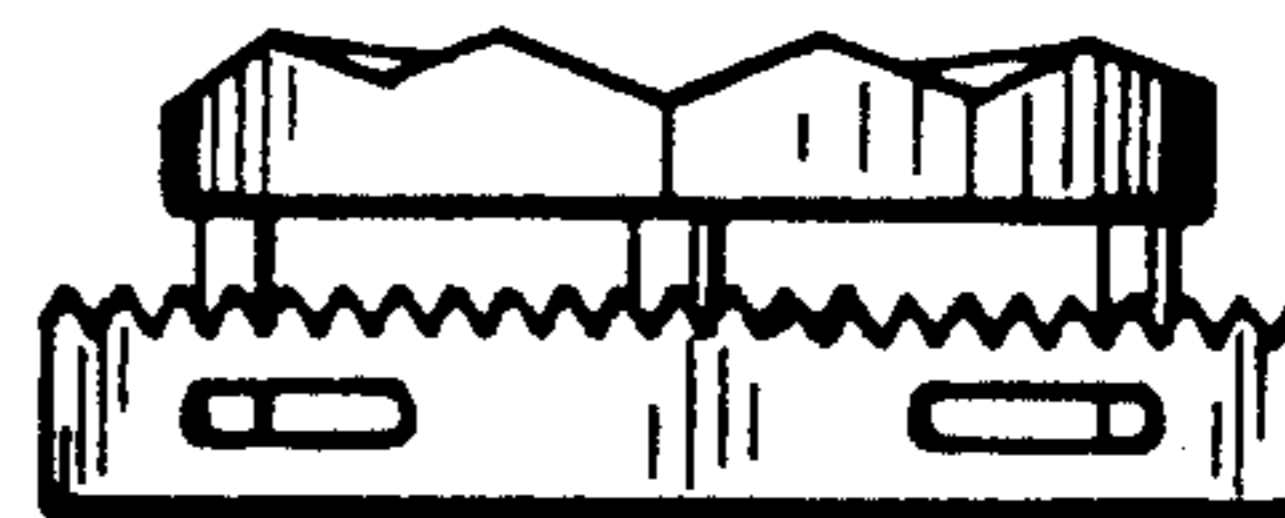

FIG. 20

FIG. 21

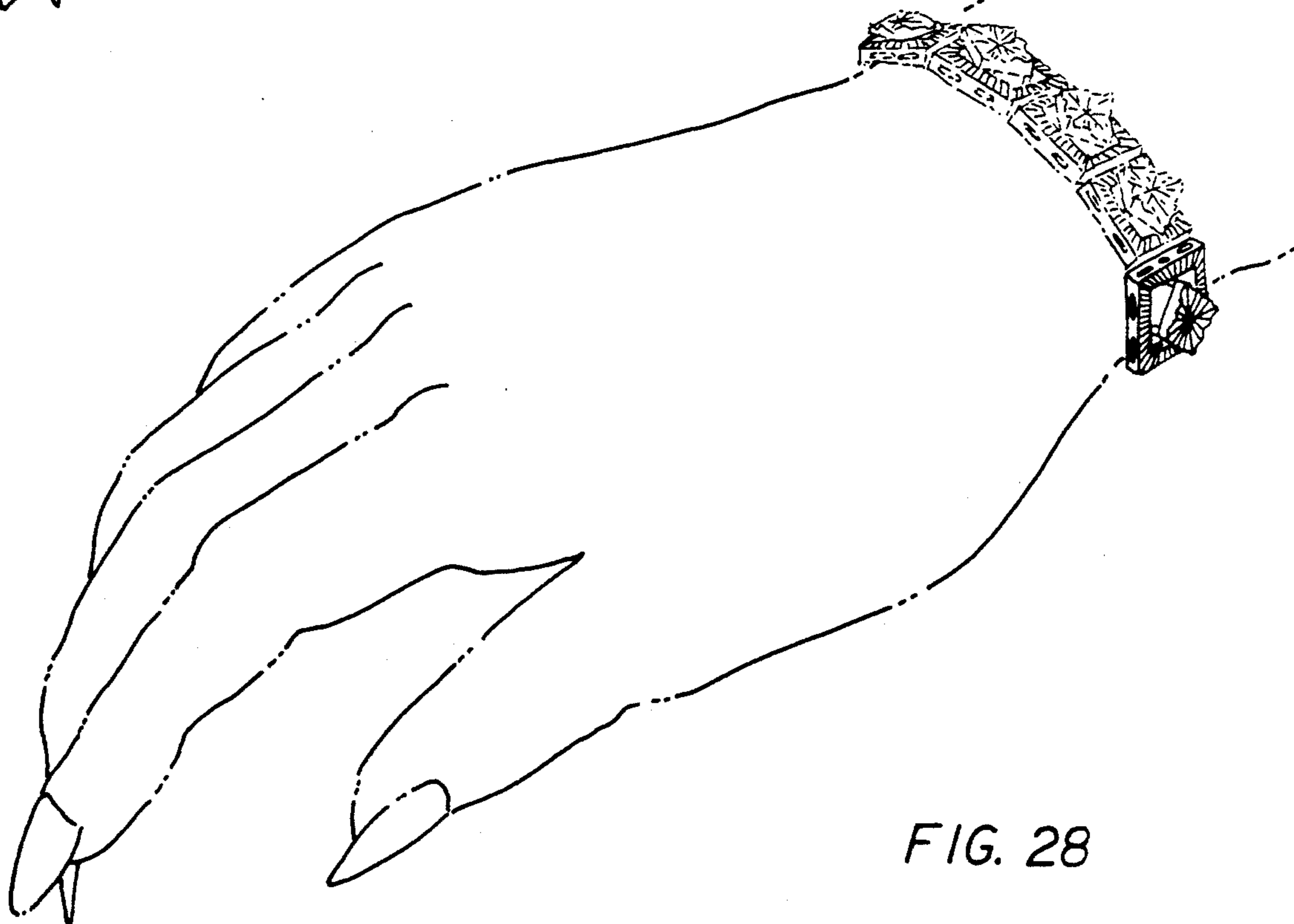
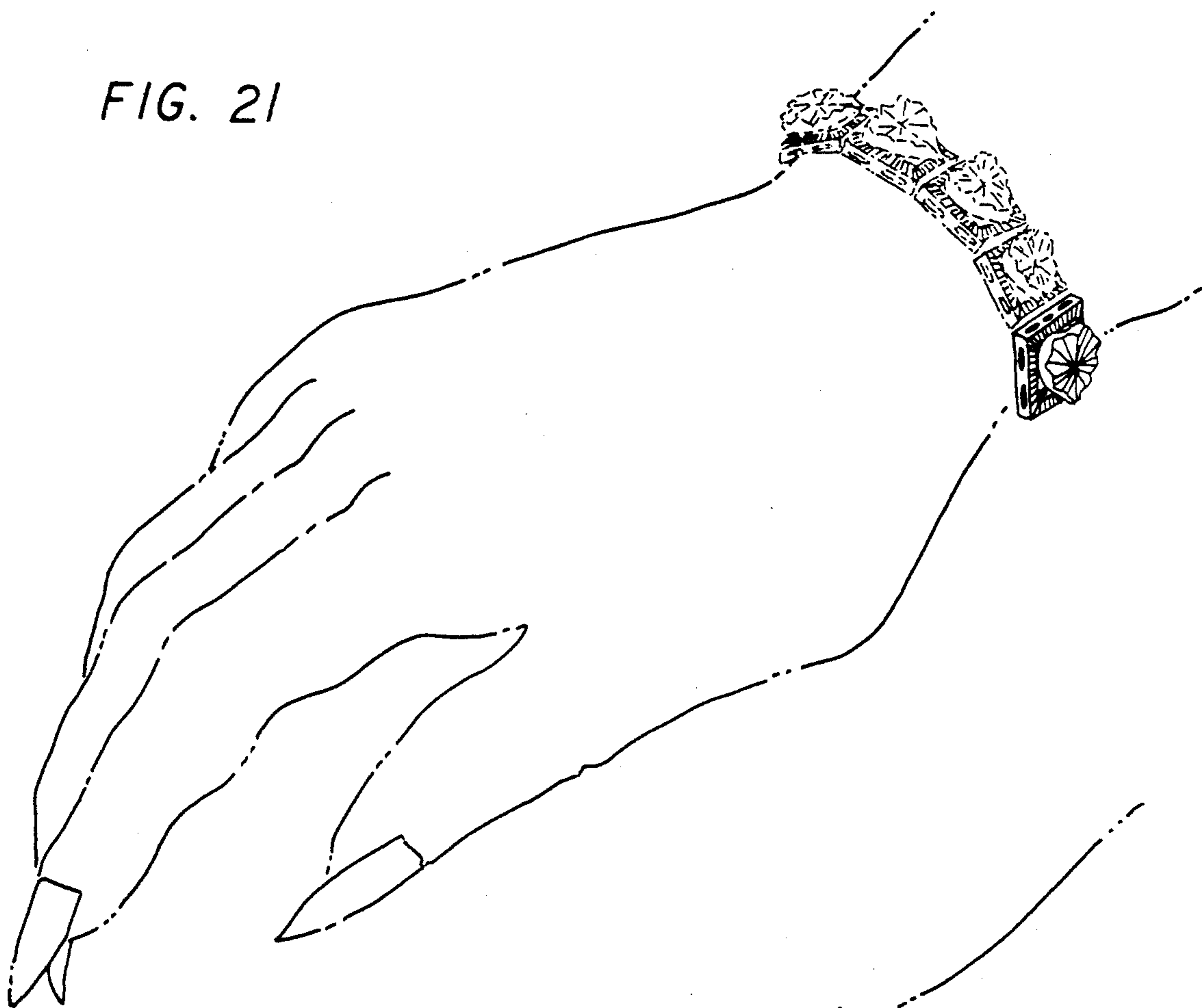

FIG. 28

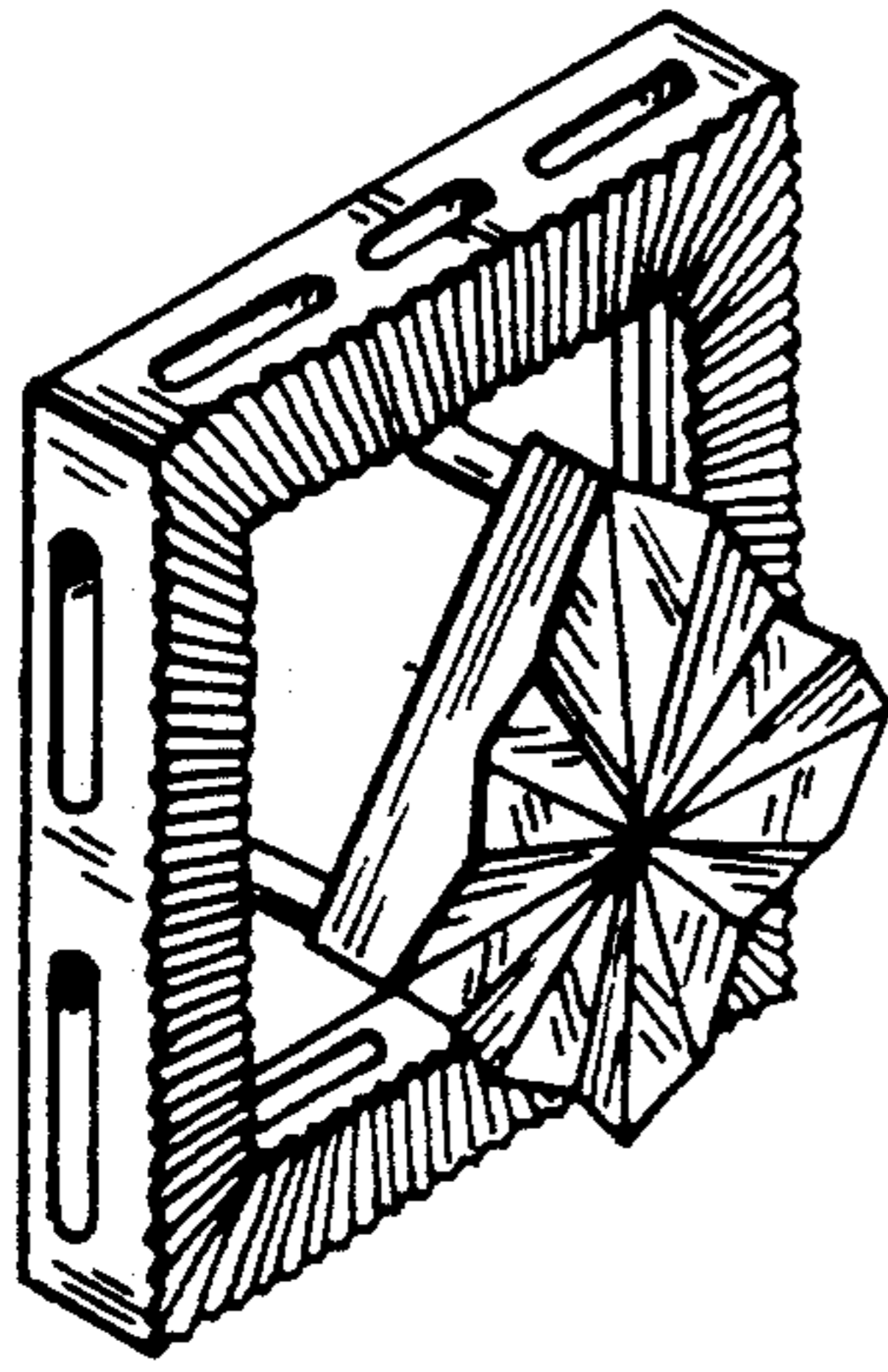

FIG. 22

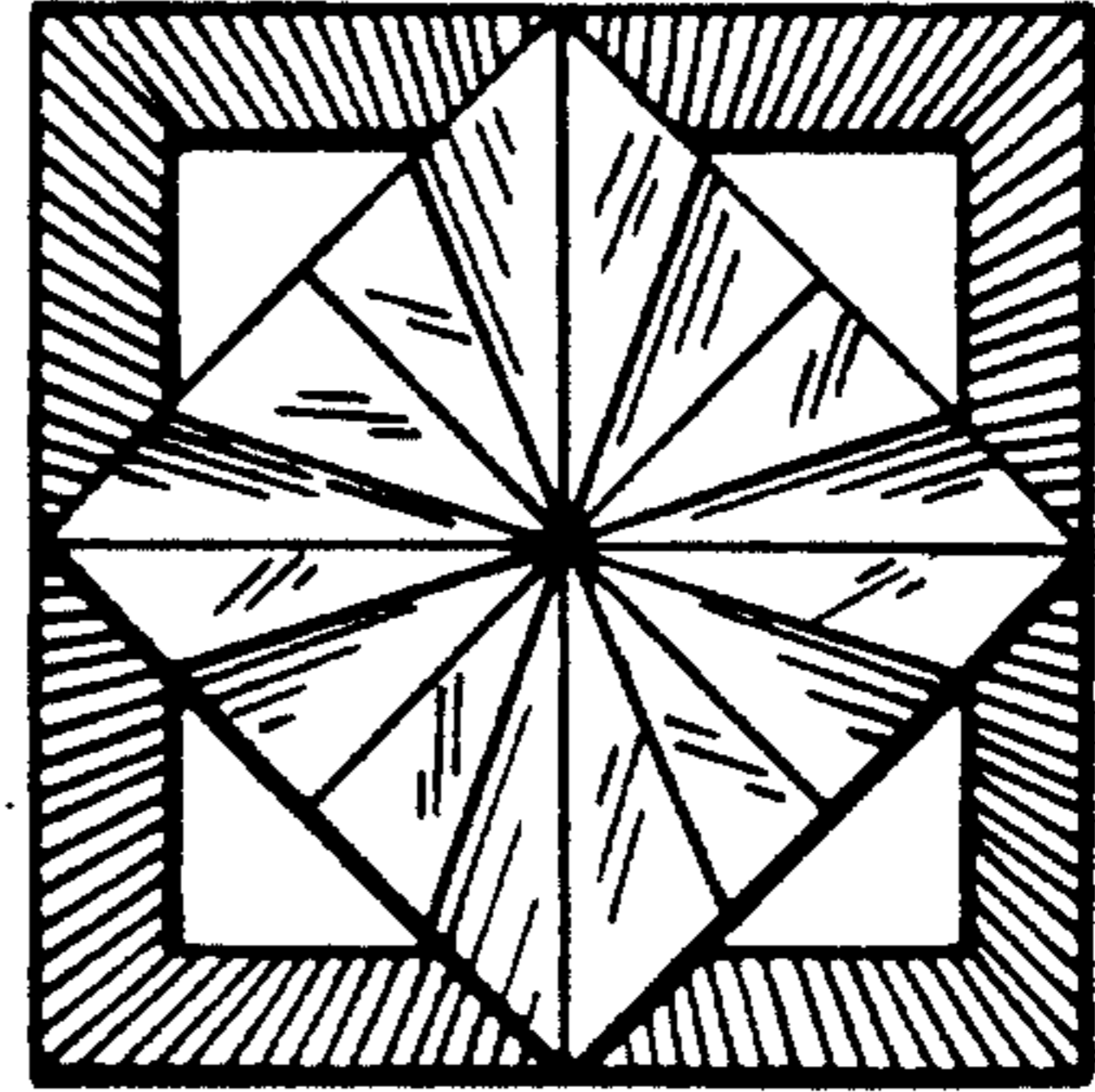

FIG. 23

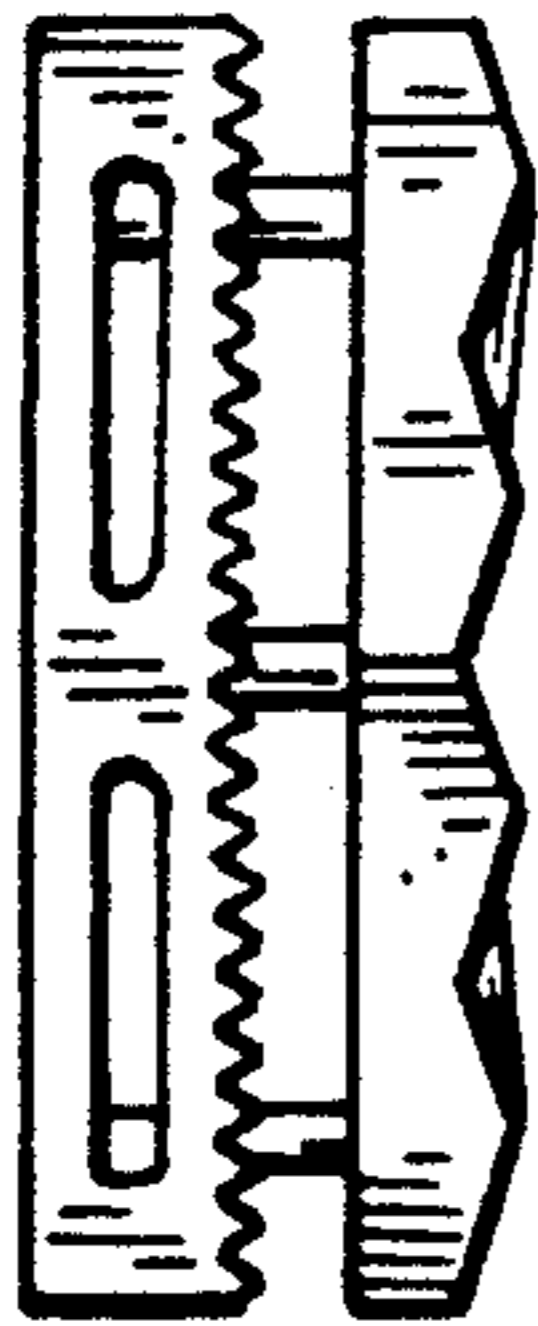

FIG. 24

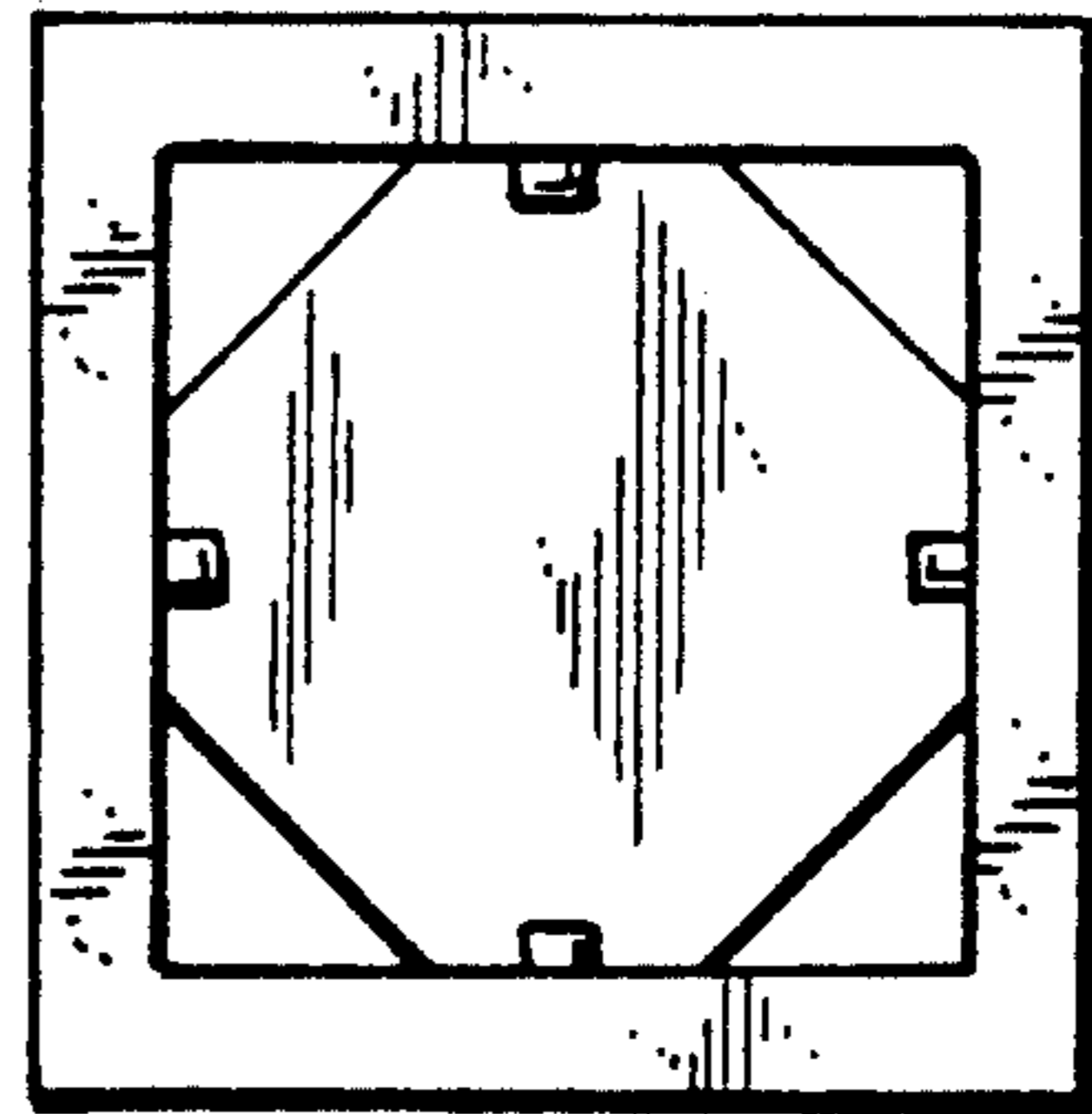

FIG. 25

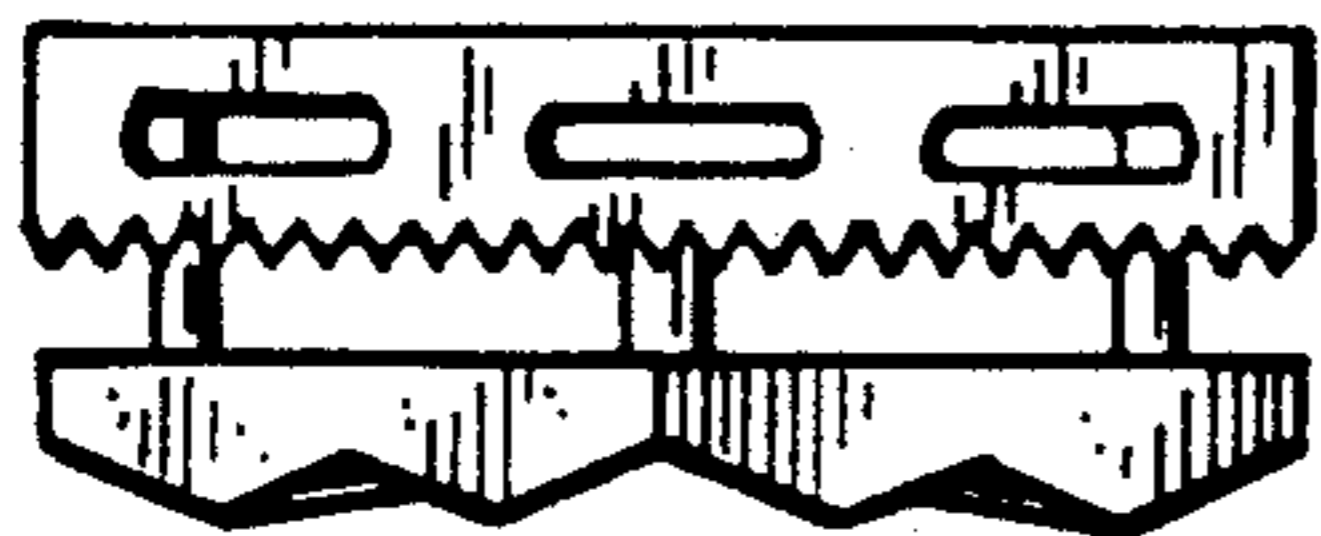

FIG. 26

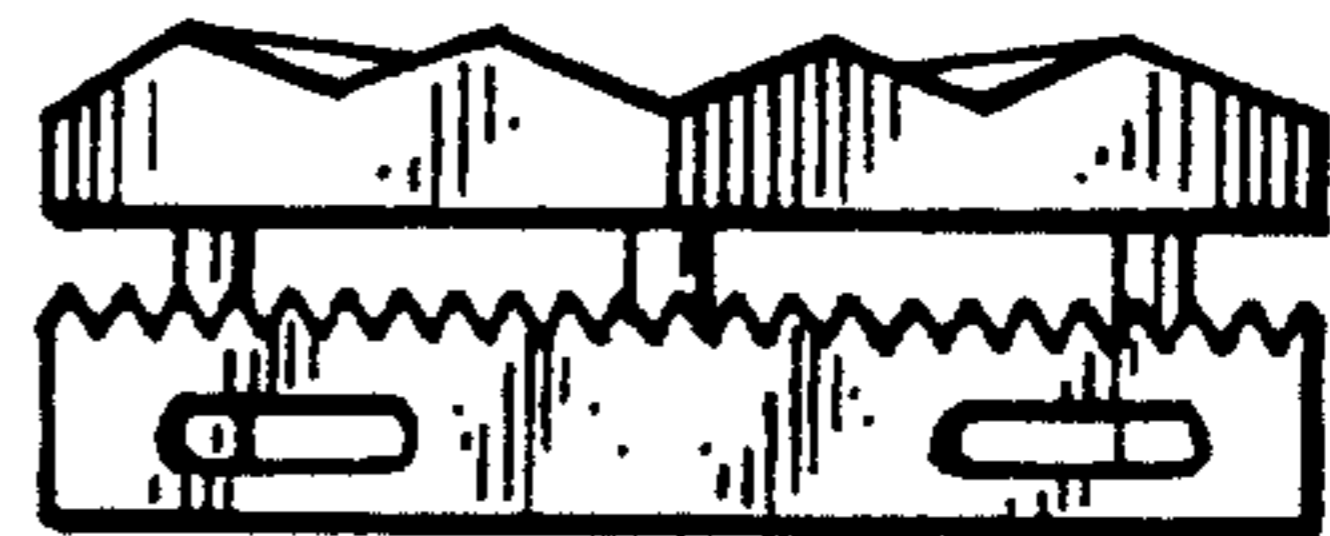

FIG. 27



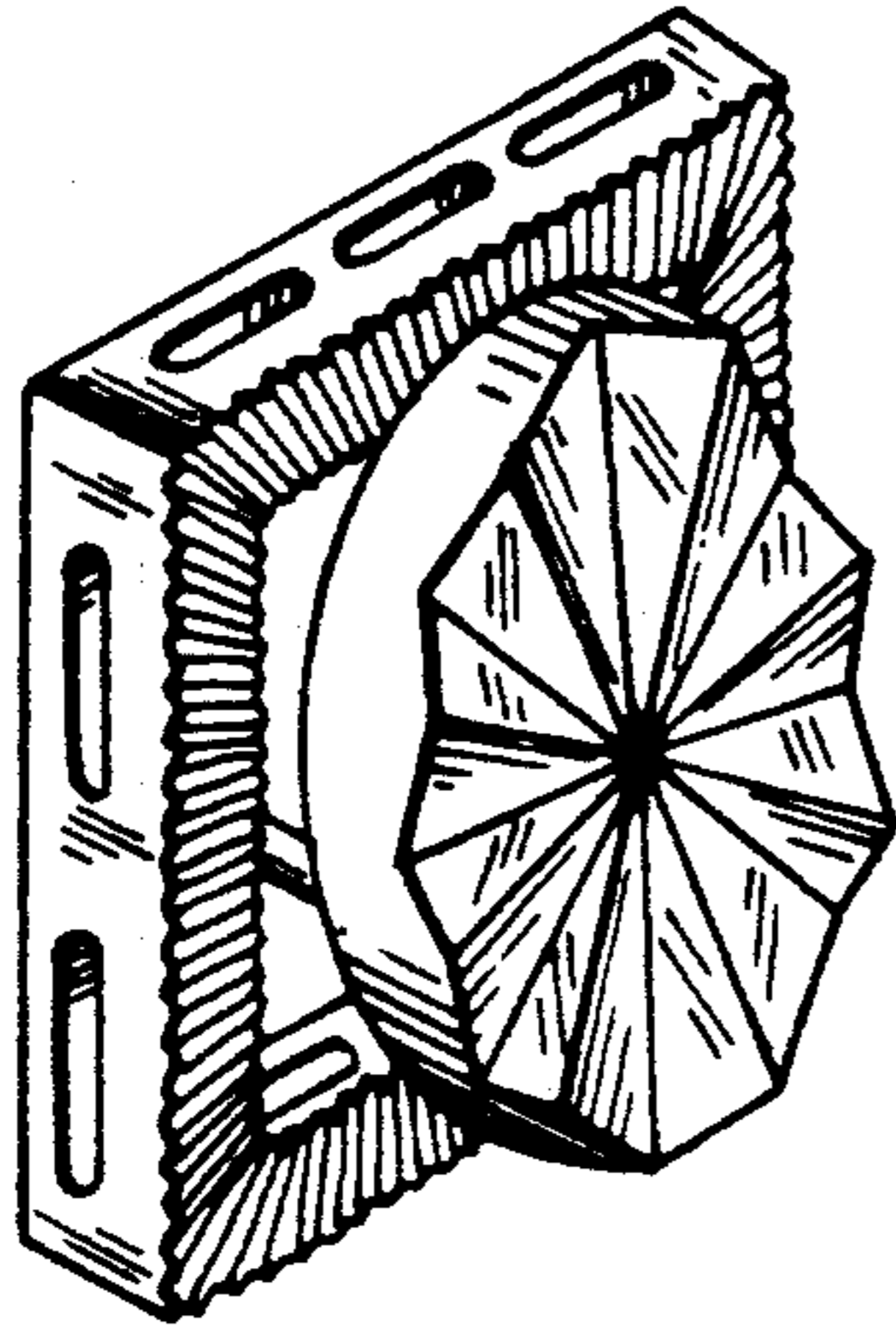

FIG. 29

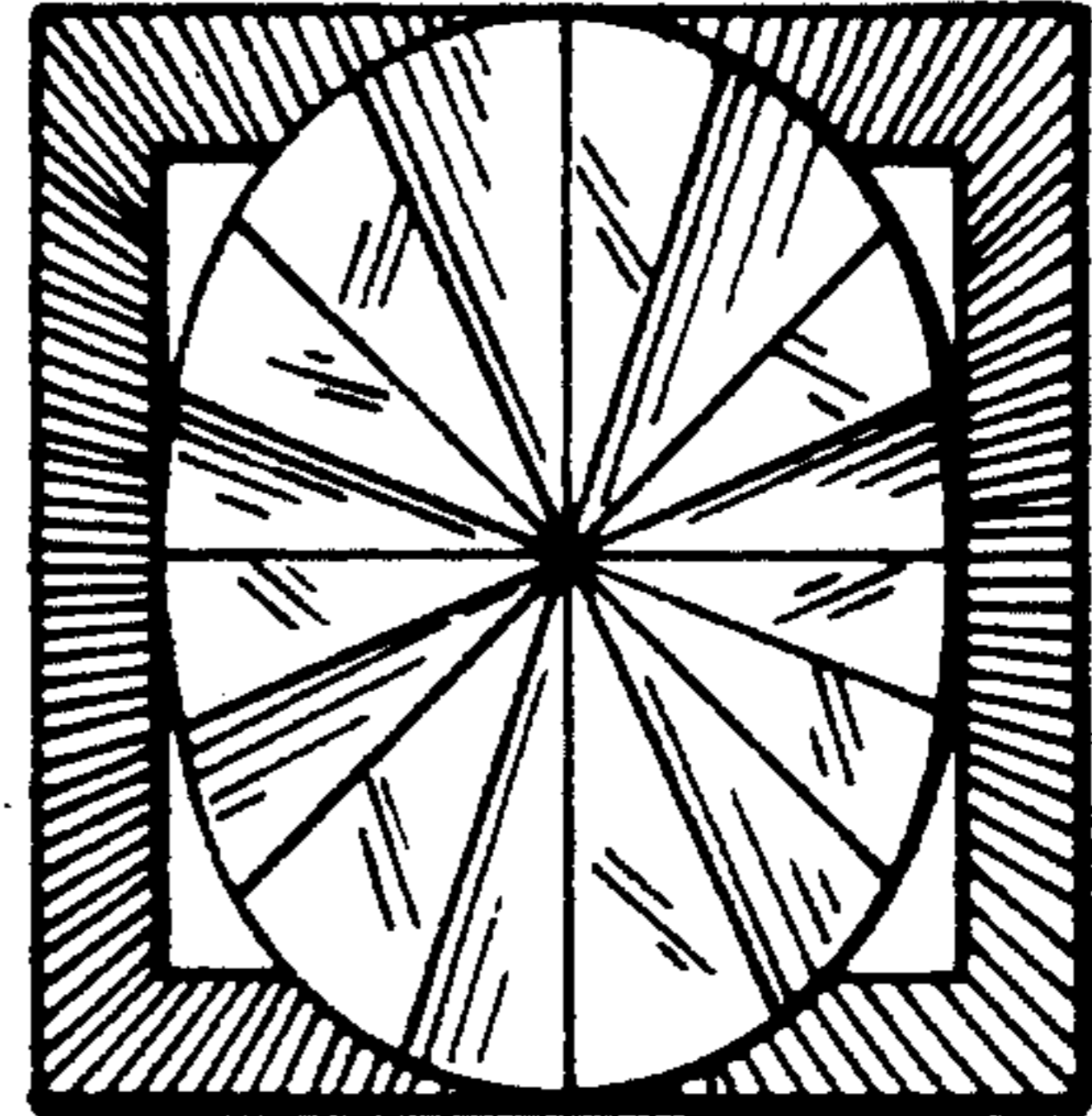

FIG. 30

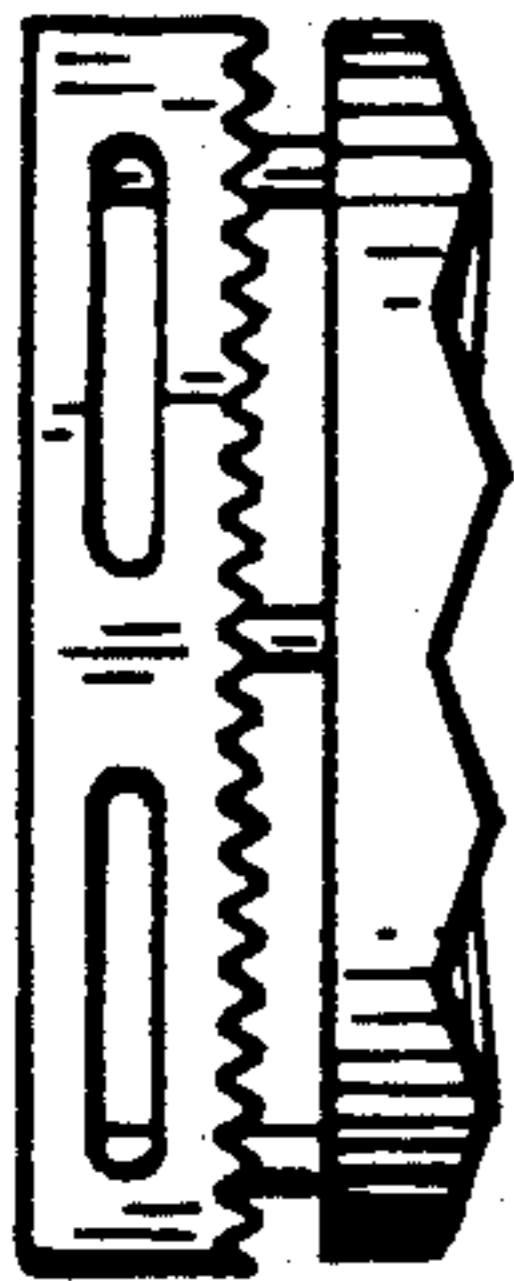

FIG. 31

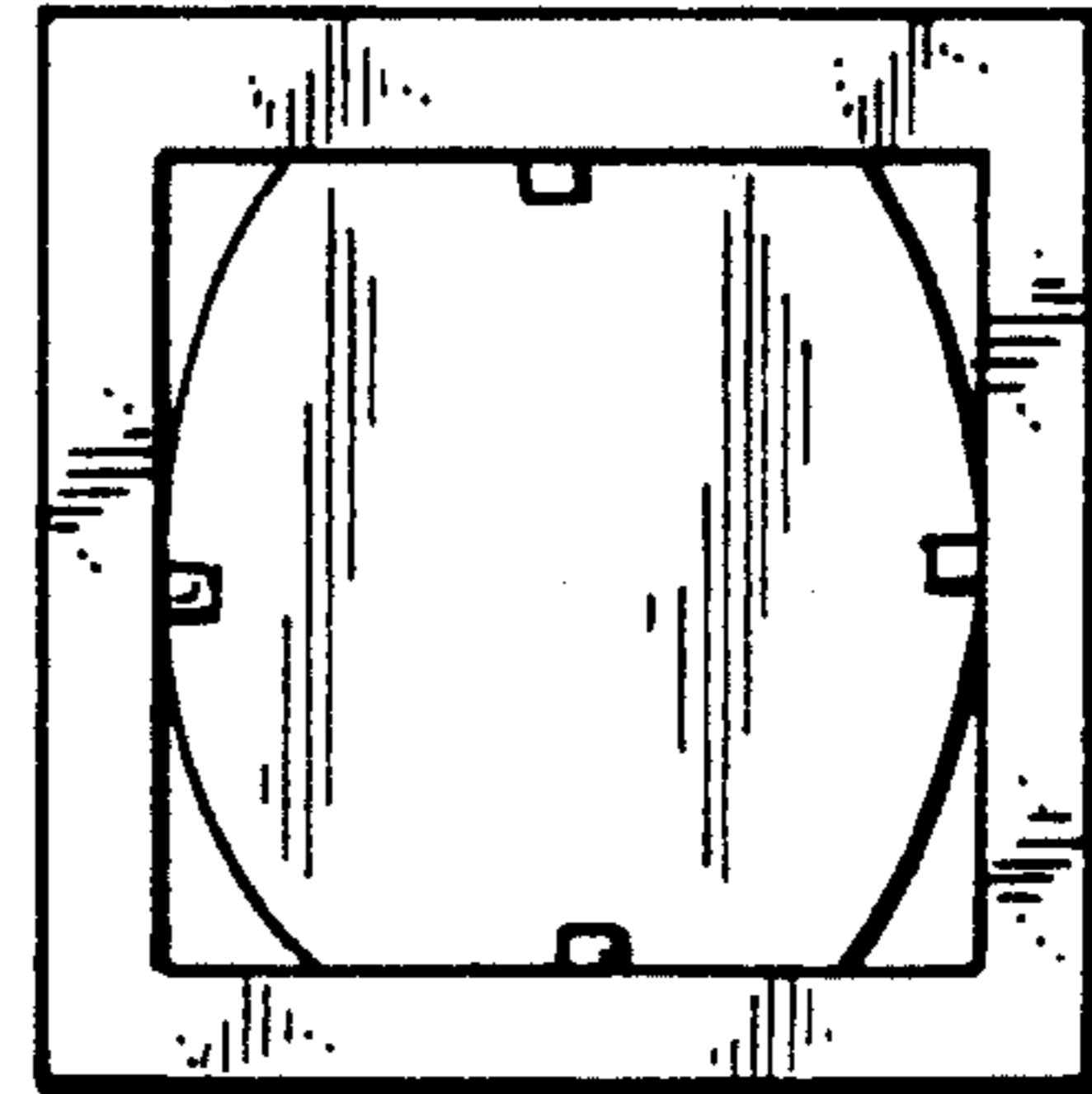

FIG. 32

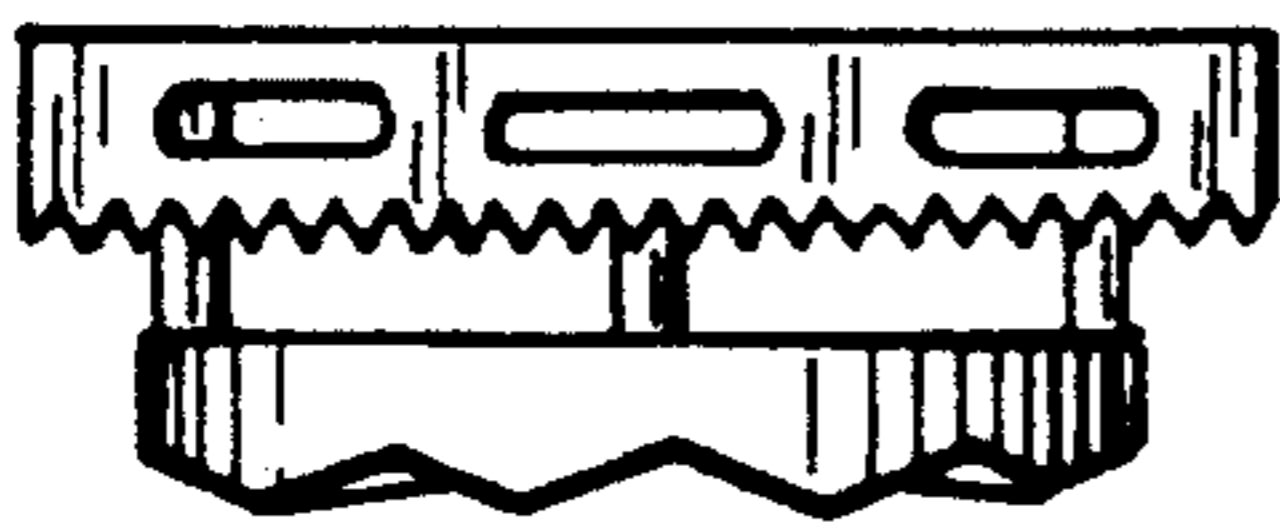

FIG. 33



FIG. 34

FIG. 35

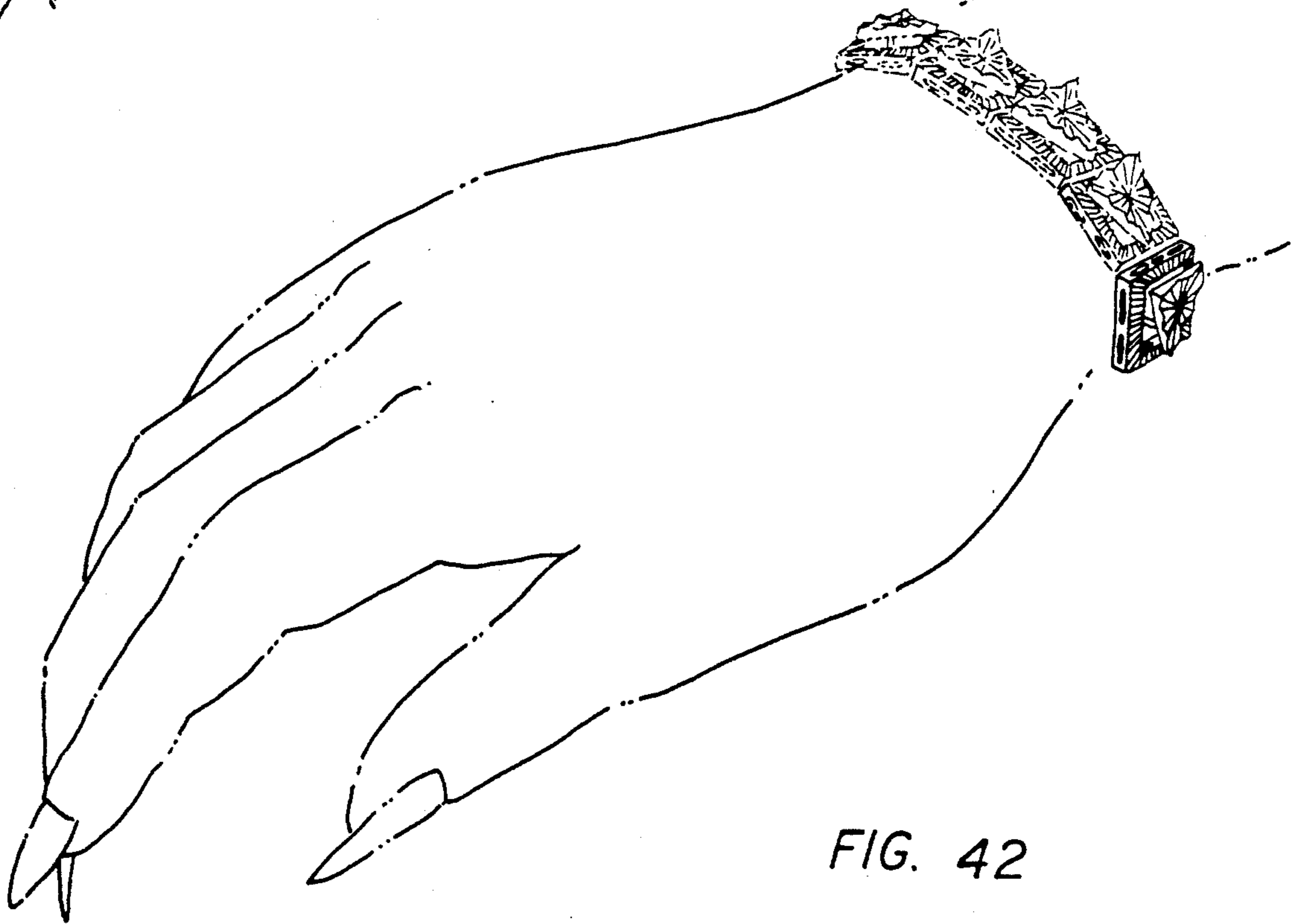
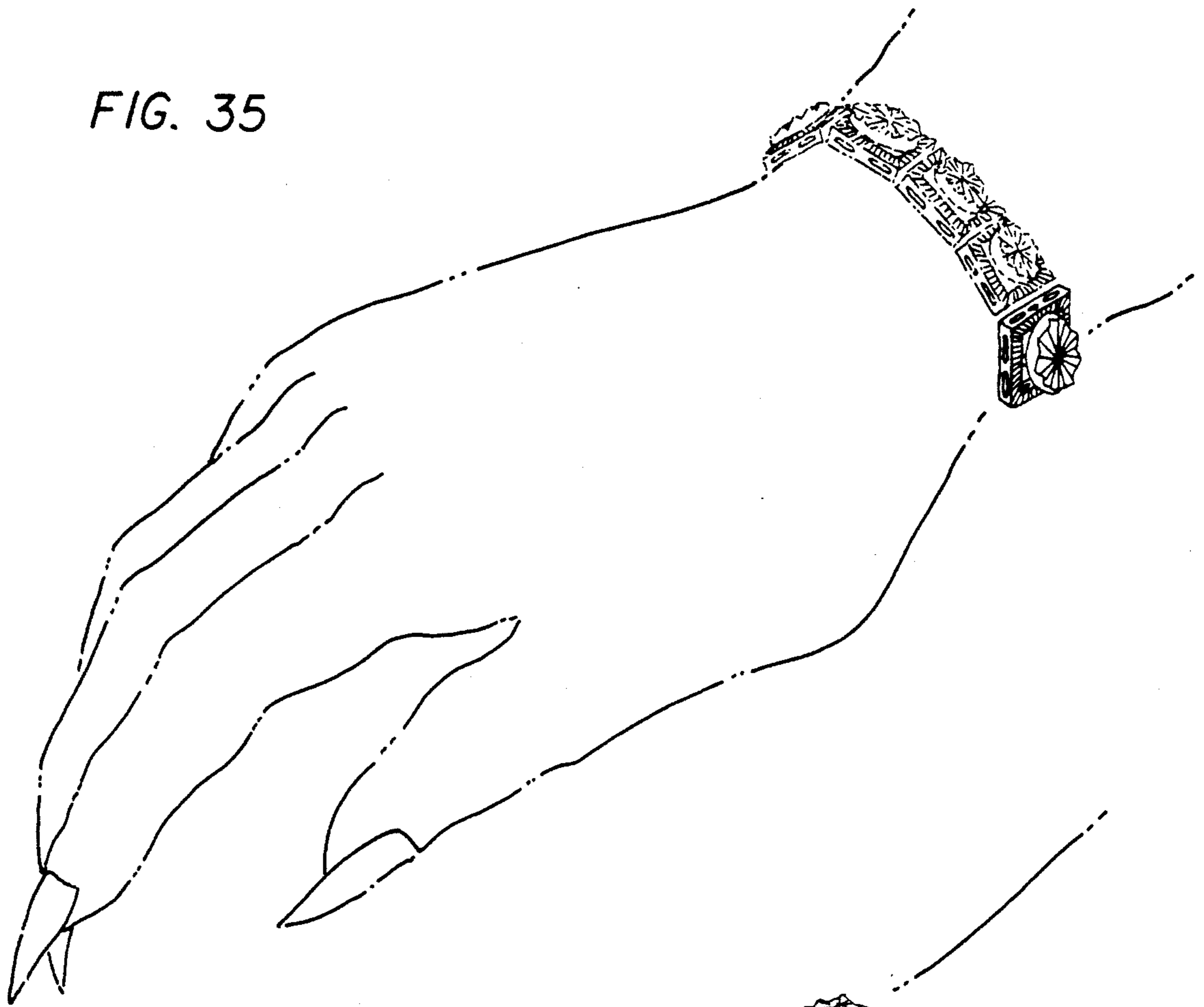

FIG. 42

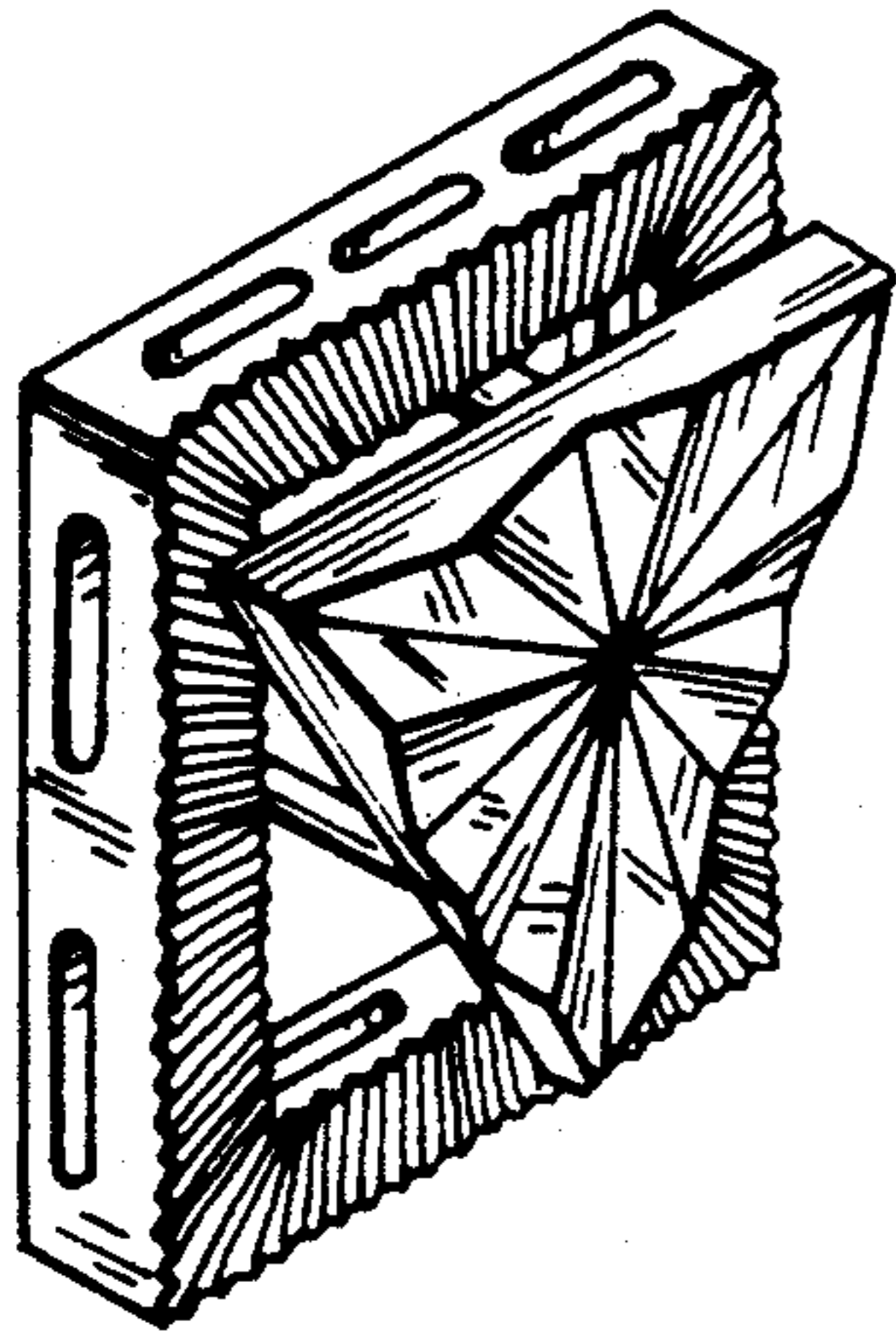

FIG. 36

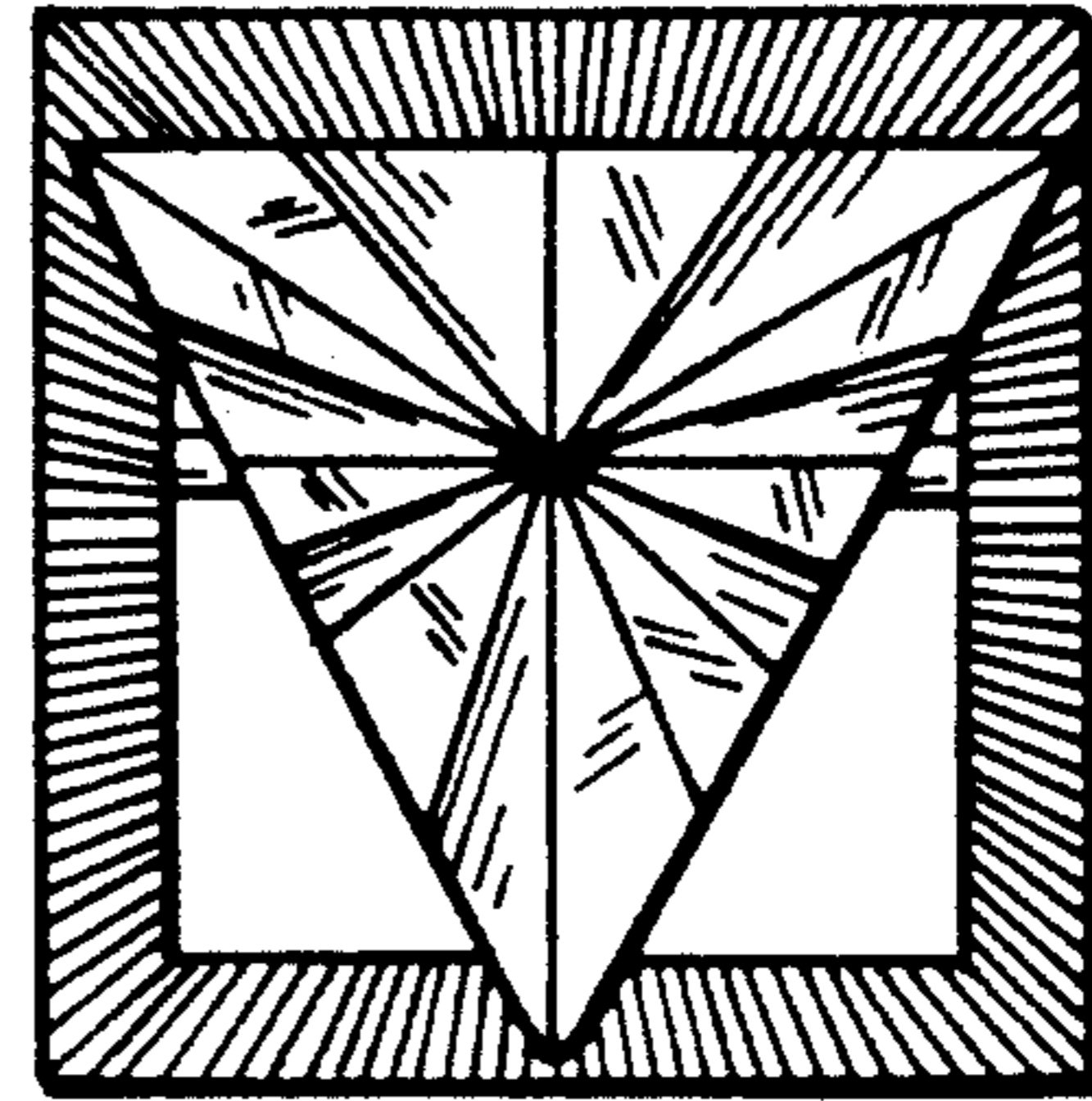

FIG. 37

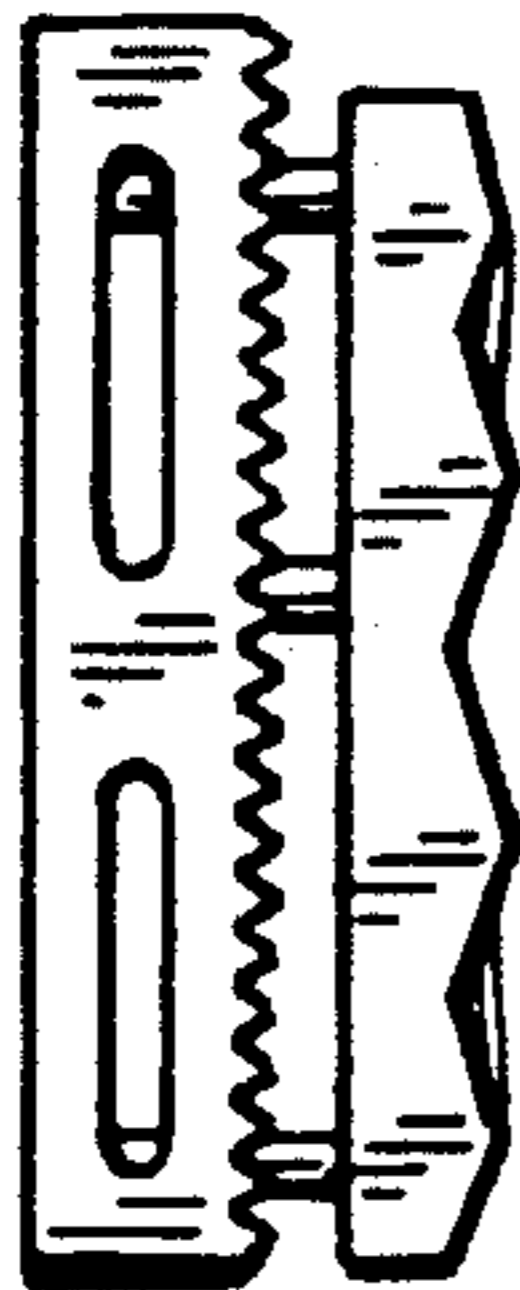

FIG. 38

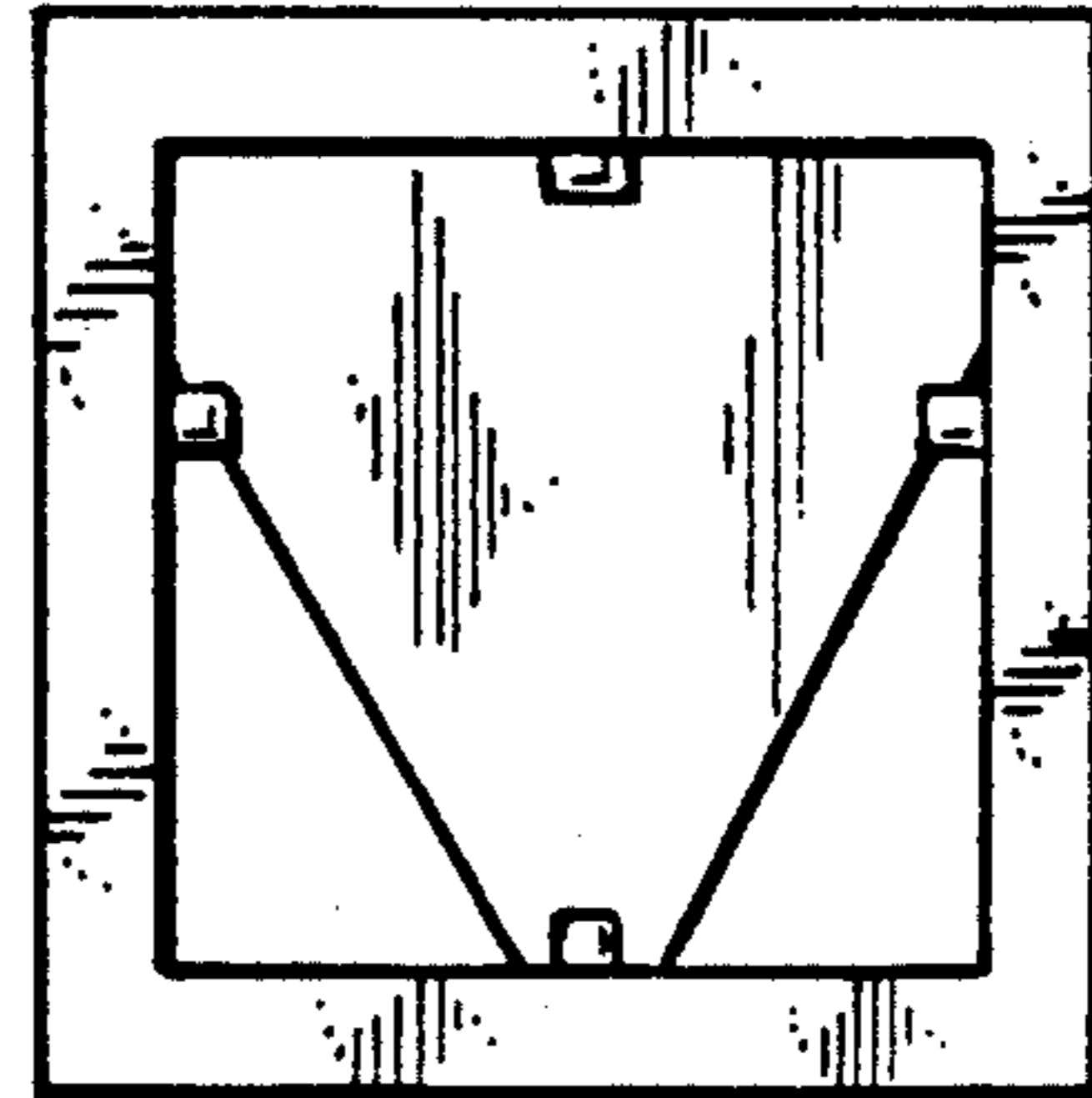

FIG. 39

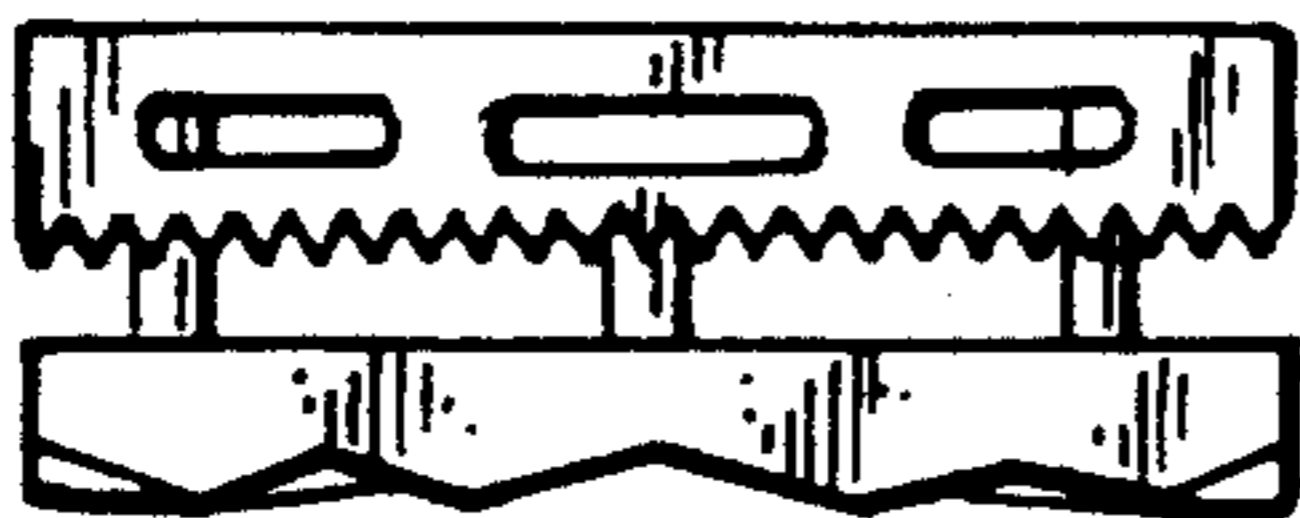

FIG. 40



FIG. 41