



US00D336007S

# United States Patent [19]

[11] Patent Number: **Des. 336,007**

King et al.

[45] Date of Patent: **\*\* Jun. 1, 1993**

[54] **LARGE CAPACITY PRESSURE COOKER**

[75] Inventors: **James D. King, Dayton; Stephen D. Werts, Eaton, both of Ohio**

[73] Assignee: **Henny Penny Corporation, Eaton, Ohio**

[\*\*] Term: **14 Years**

[21] Appl. No.: **475,479**

[22] Filed: **Feb. 5, 1990**

[52] U.S. Cl. .... **D7/347; D7/339**

[58] Field of Search ..... **D7/323, 339-341, D7/346-348; 99/330, 403-404, 407-411, 413-418, 336-337, 355, 359; 219/440-441, 386**

[56] **References Cited**

**U.S. PATENT DOCUMENTS**

D. 180,431	6/1957	Wagner	.....	D7/347
D. 186,345	10/1959	Pappas	.....	D7/339
D. 192,132	1/1962	Nelson	.....	D7/347
D. 205,633	8/1966	Payne	.....	D7/339
D. 215,383	9/1969	Moore et al.	.....	D7/339
D. 218,498	8/1970	Wilson et al.	.....	D7/347
D. 263,305	3/1982	Barnhill	.....	D7/347
3,187,664	6/1965	Jennings	.....	99/329
3,501,316	3/1970	Guthrie	.....	99/107
3,563,158	2/1971	Omer	.....	99/326
3,608,472	9/1971	Peister et al.	.....	99/327
3,635,722	1/1972	Moore	.....	99/1
3,690,246	9/1972	Guthrie	.....	99/336
3,821,925	7/1974	Moore	.....	99/327
4,930,408	6/1990	King et al.	.....	99/407
4,945,893	8/1990	Manchester	.....	99/403

**OTHER PUBLICATIONS**

KFC National Management Co., Mfg. Division 20--

Head Automatic Cooker Specification Sheet, Mar. 1990.

*Primary Examiner*—A. Hugo Word  
*Assistant Examiner*—Ruth McInroy  
*Attorney, Agent, or Firm*—Frost & Jacobs

[57] **CLAIM**

The ornamental design for a large capacity pressure cooker, as shown and described.

**DESCRIPTION**

FIG. 1 is a front elevational view of a large capacity pressure cooker showing our new design; FIG. 2 is a left side elevational view thereof; FIG. 3 is a right side elevational view thereof; FIG. 4 is a top plan view thereof; FIG. 5 is a rear elevational view thereof; FIG. 6 is a top, front and right side perspective view thereof; FIG. 7 is a front elevational view of a second embodiment thereof; FIG. 8 is a left side elevational view thereof; FIG. 9 is a right side elevational view thereof; FIG. 10 is a top plan view thereof; FIG. 11 is a front elevational view of a third embodiment thereof; FIG. 12 is a left side elevational view thereof; FIG. 13 is a right side elevational view thereof; FIG. 14 is a top plan view thereof; FIG. 15 is a front elevational view of a fourth embodiment thereof; FIG. 16 is a left side elevational view thereof; FIG. 17 is a right side elevational view thereof; and, FIG. 18 is a top plan view thereof.

The undisclosed rear view for the second, third and fourth embodiments is the same as FIG. 5.

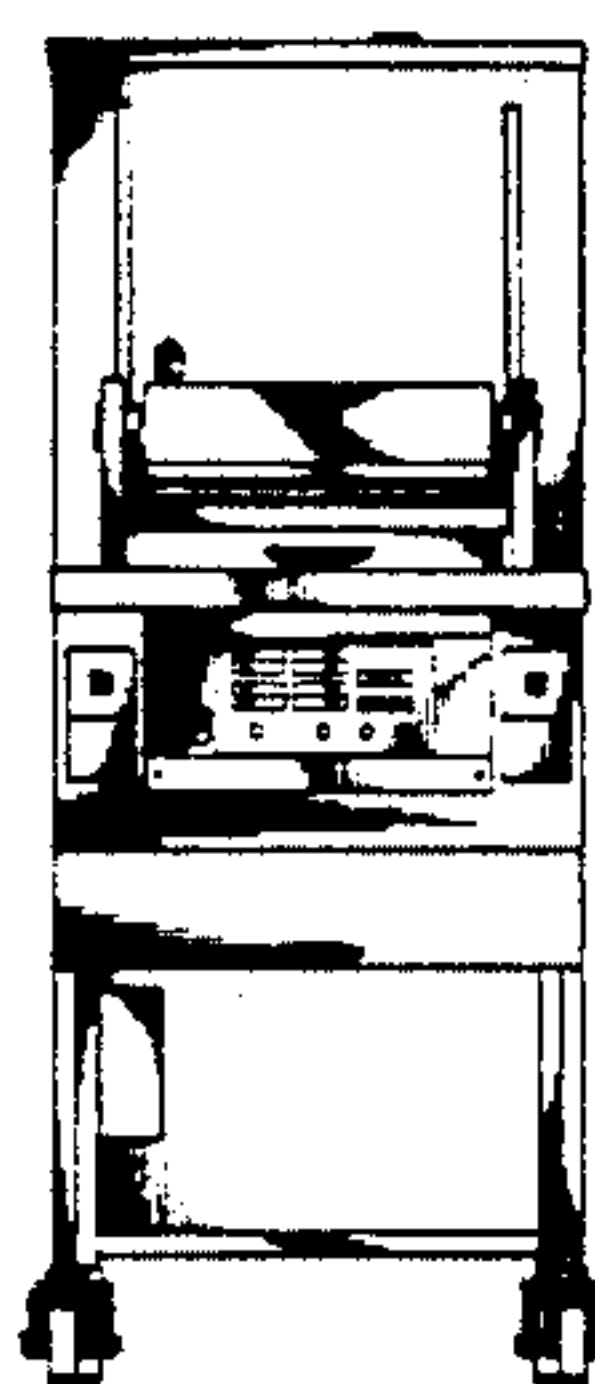
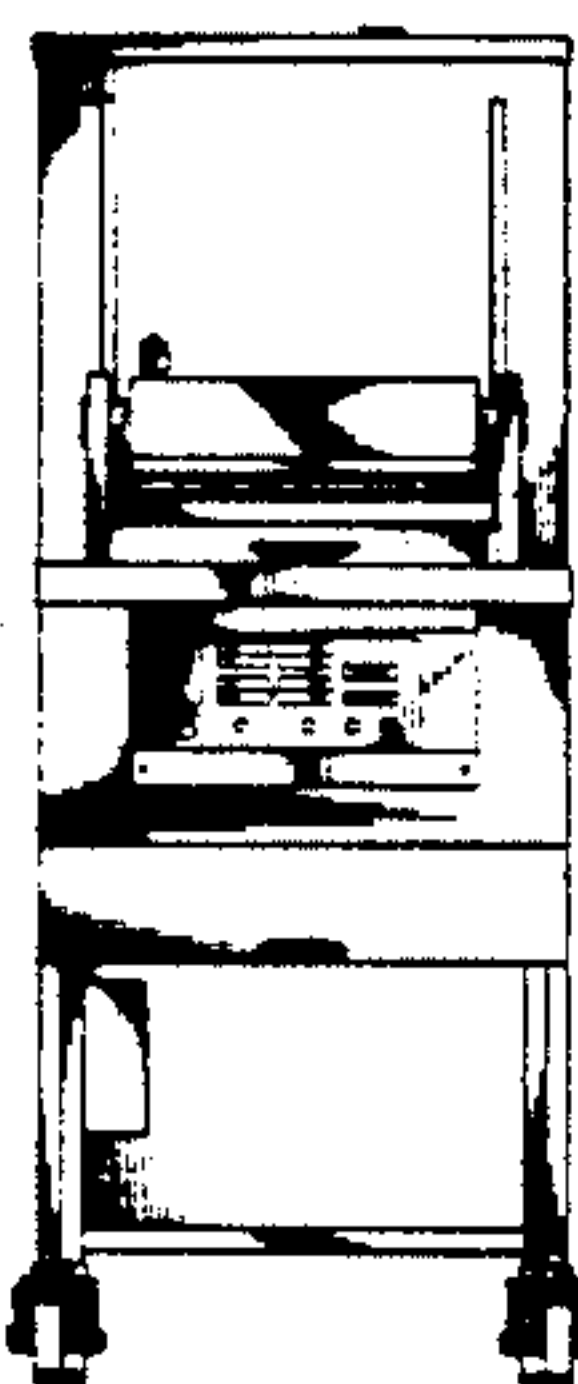
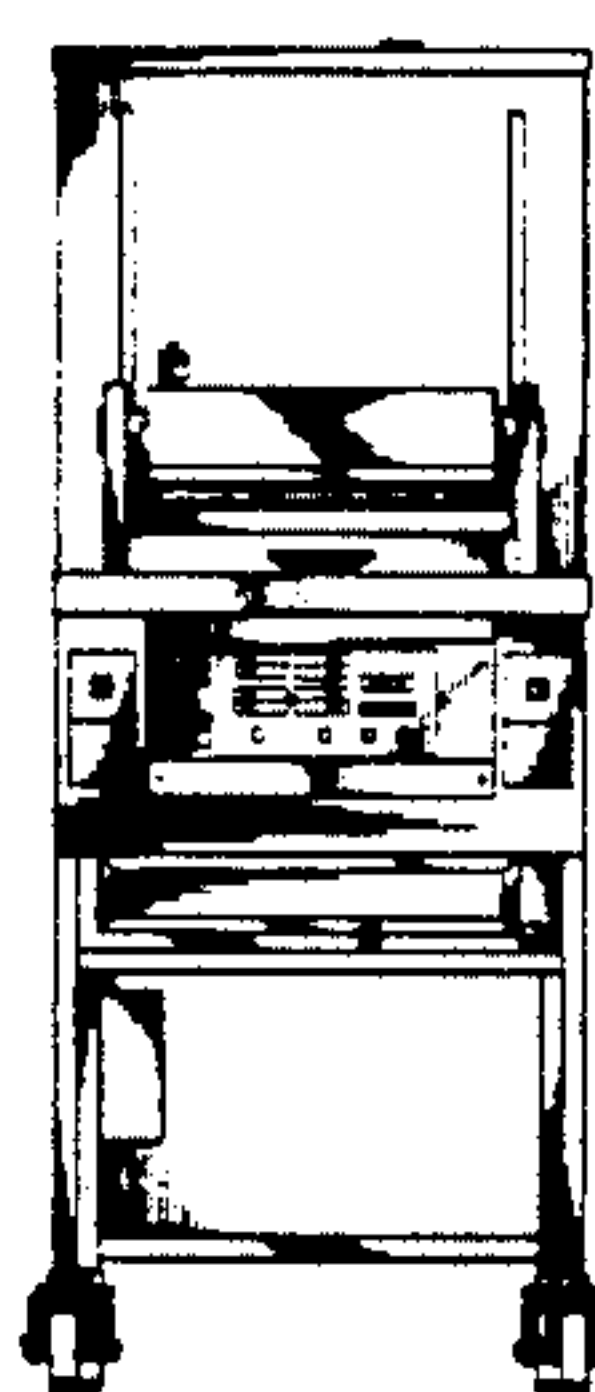
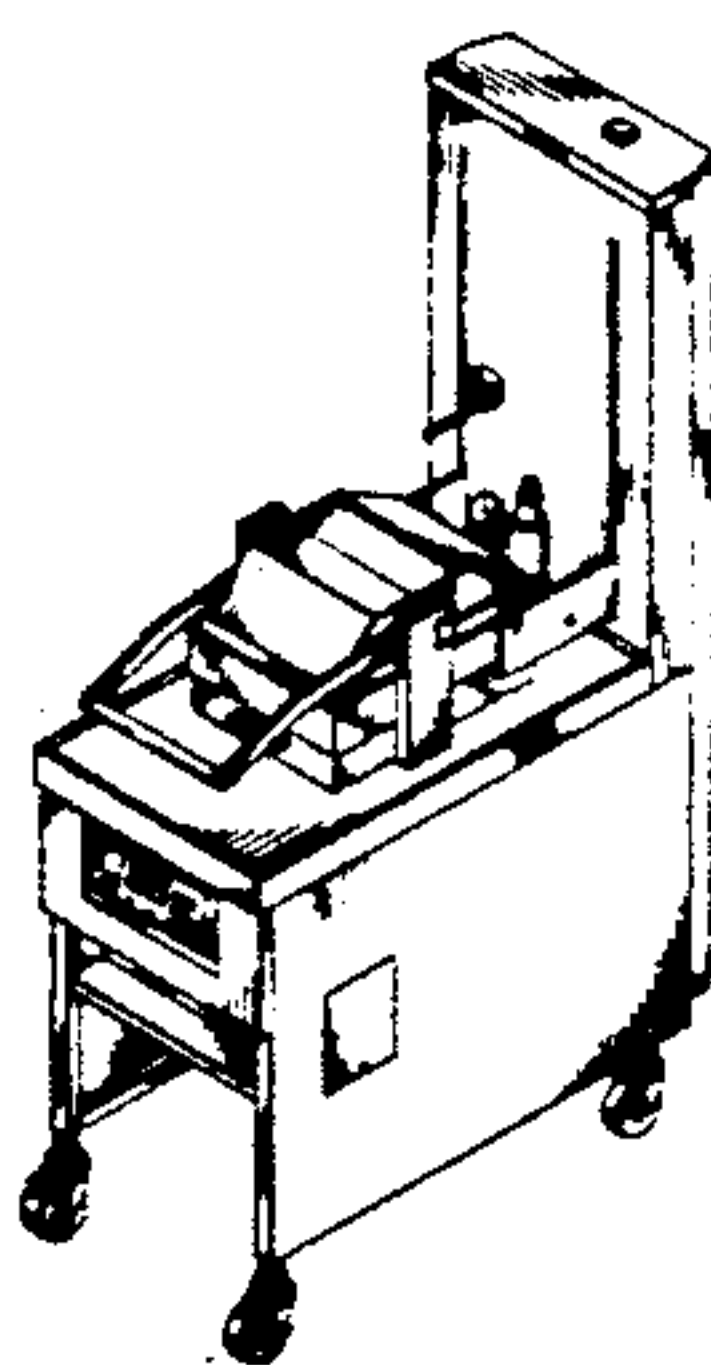

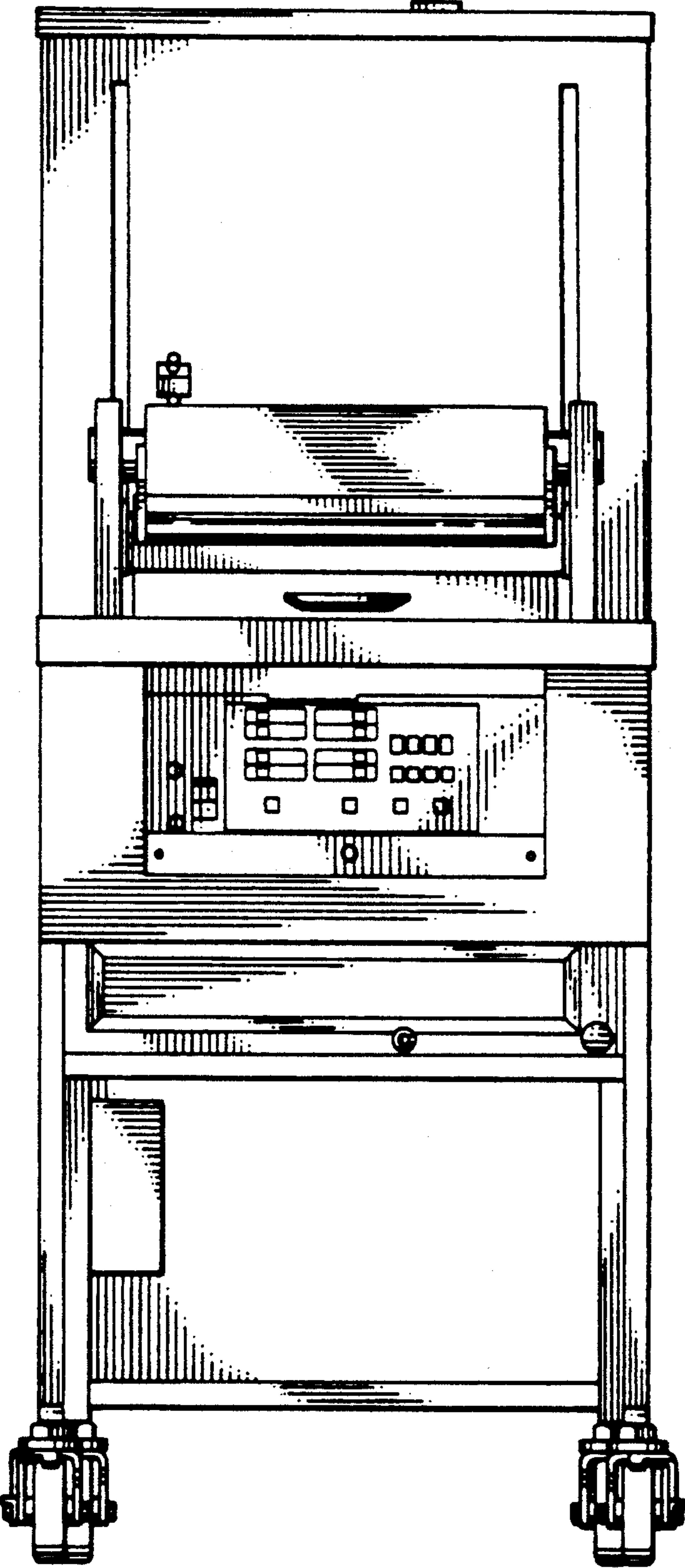

FIG. 1

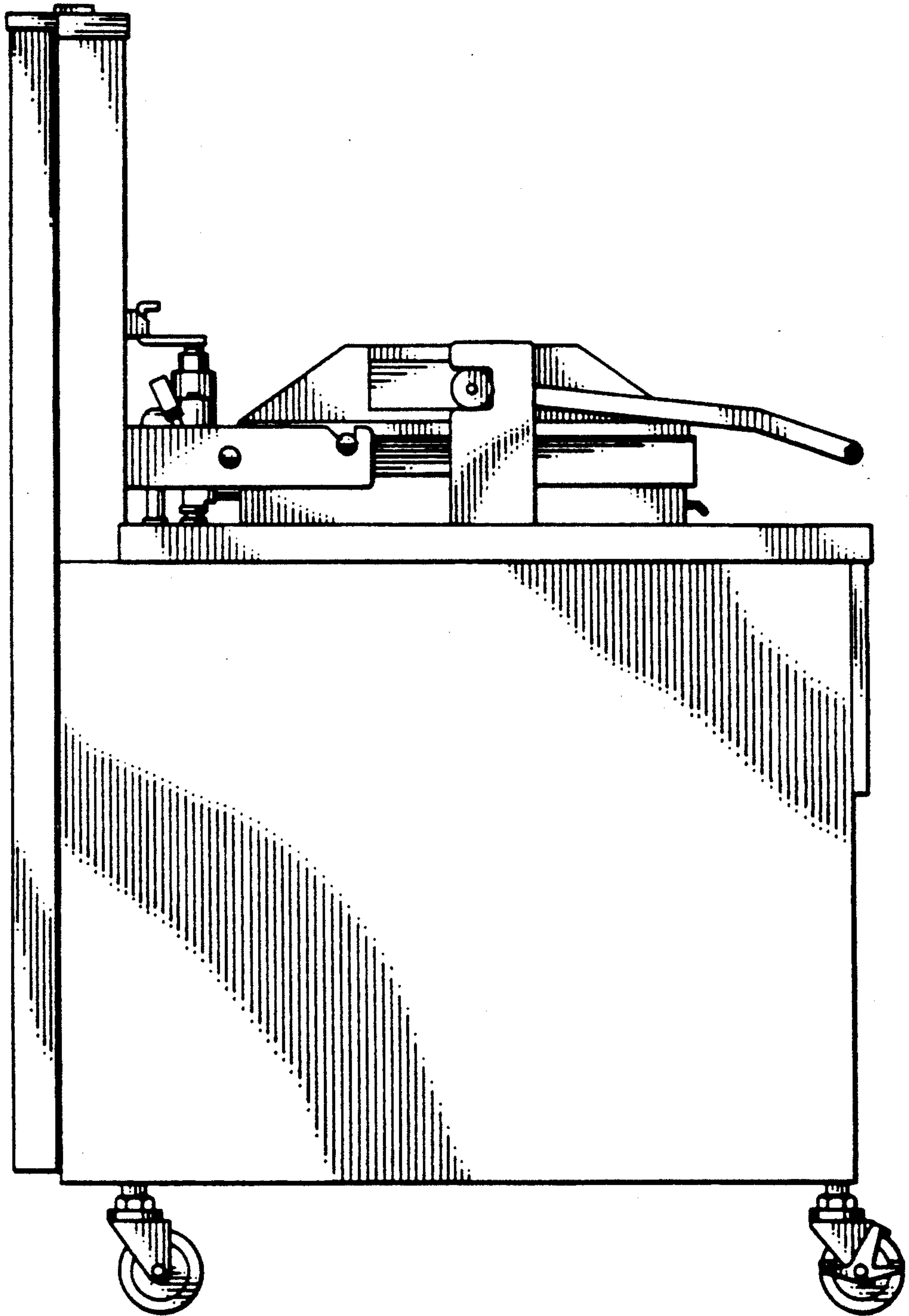

FIG. 2

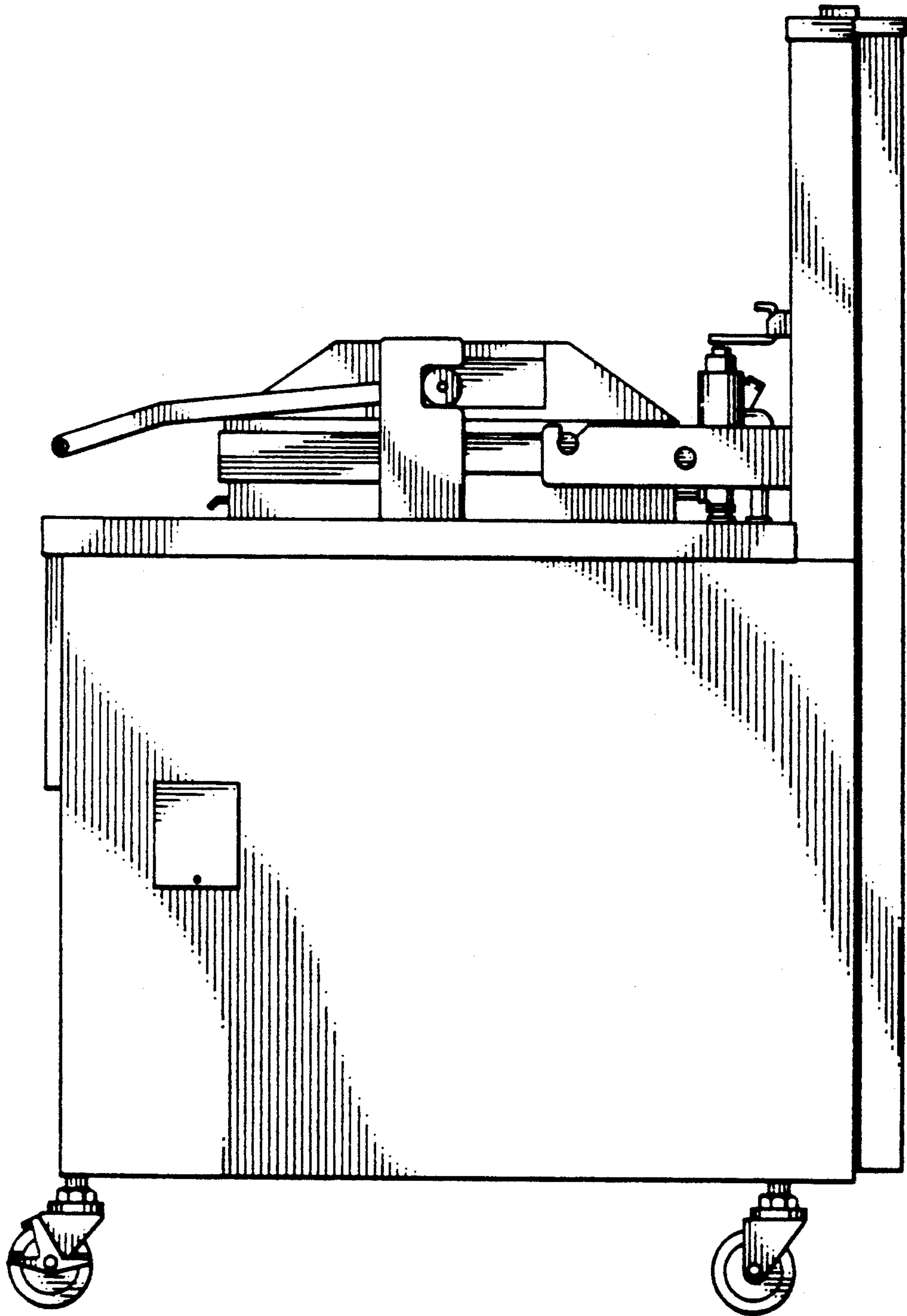

FIG. 3



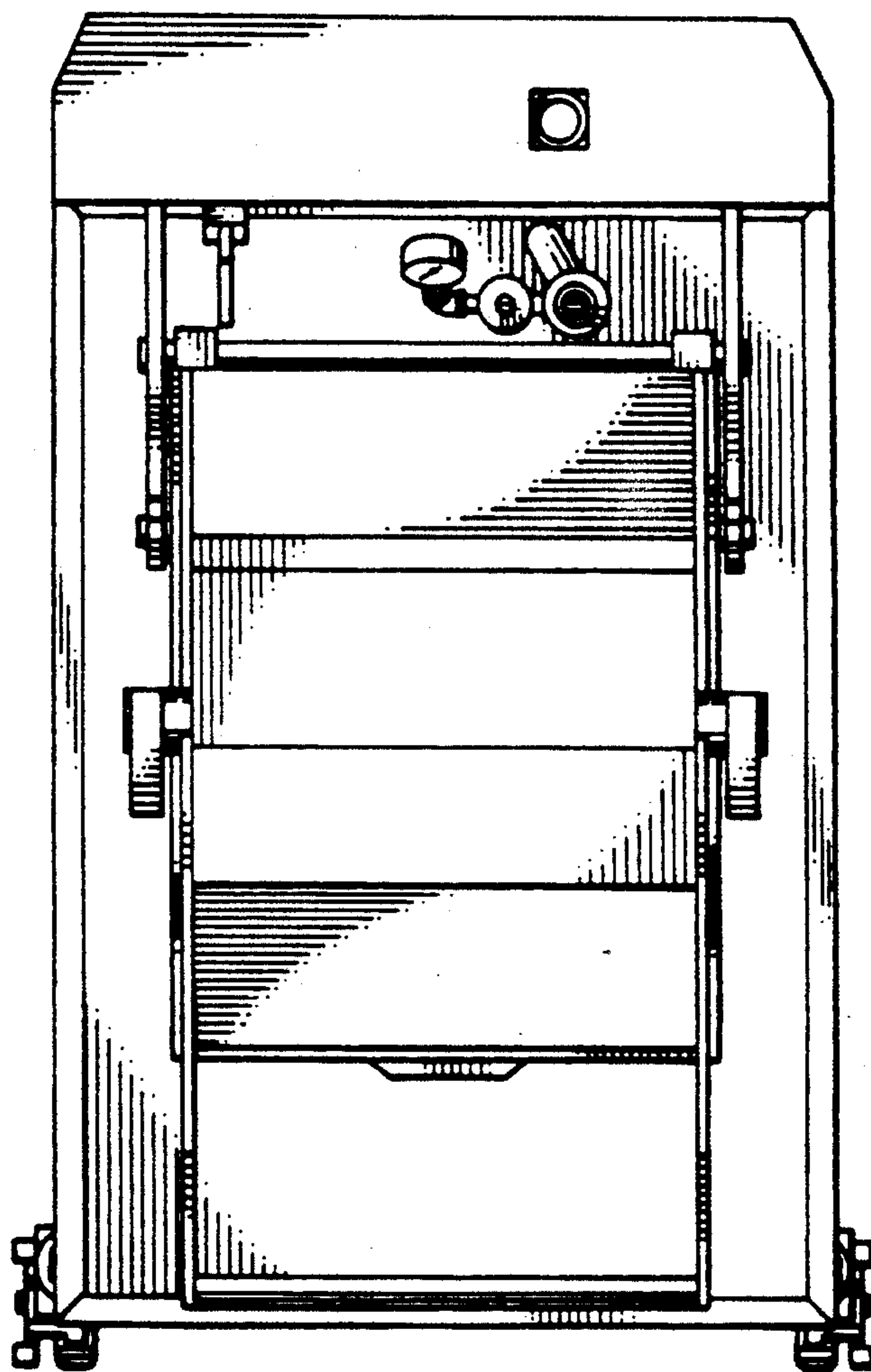

FIG. 4

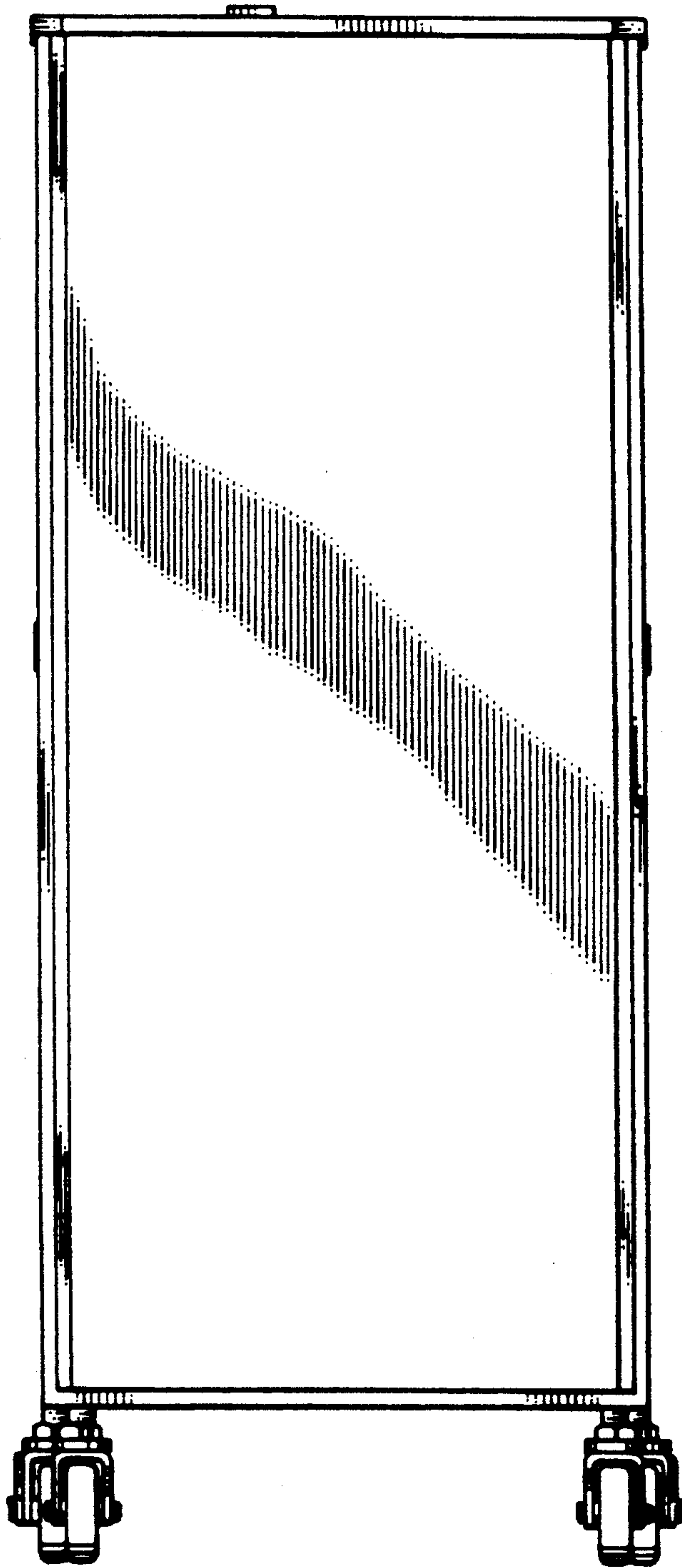

FIG. 5

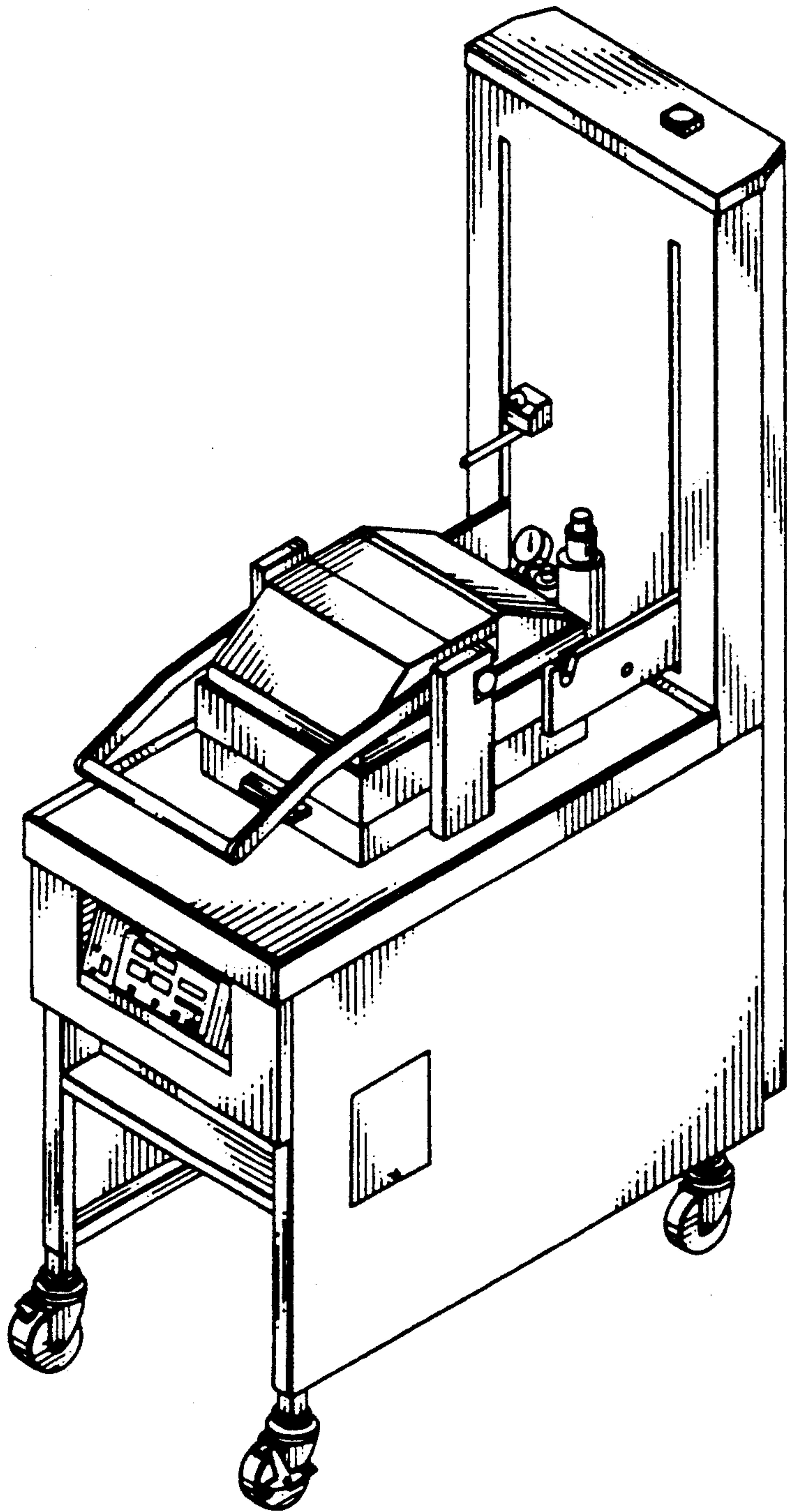

FIG. 6

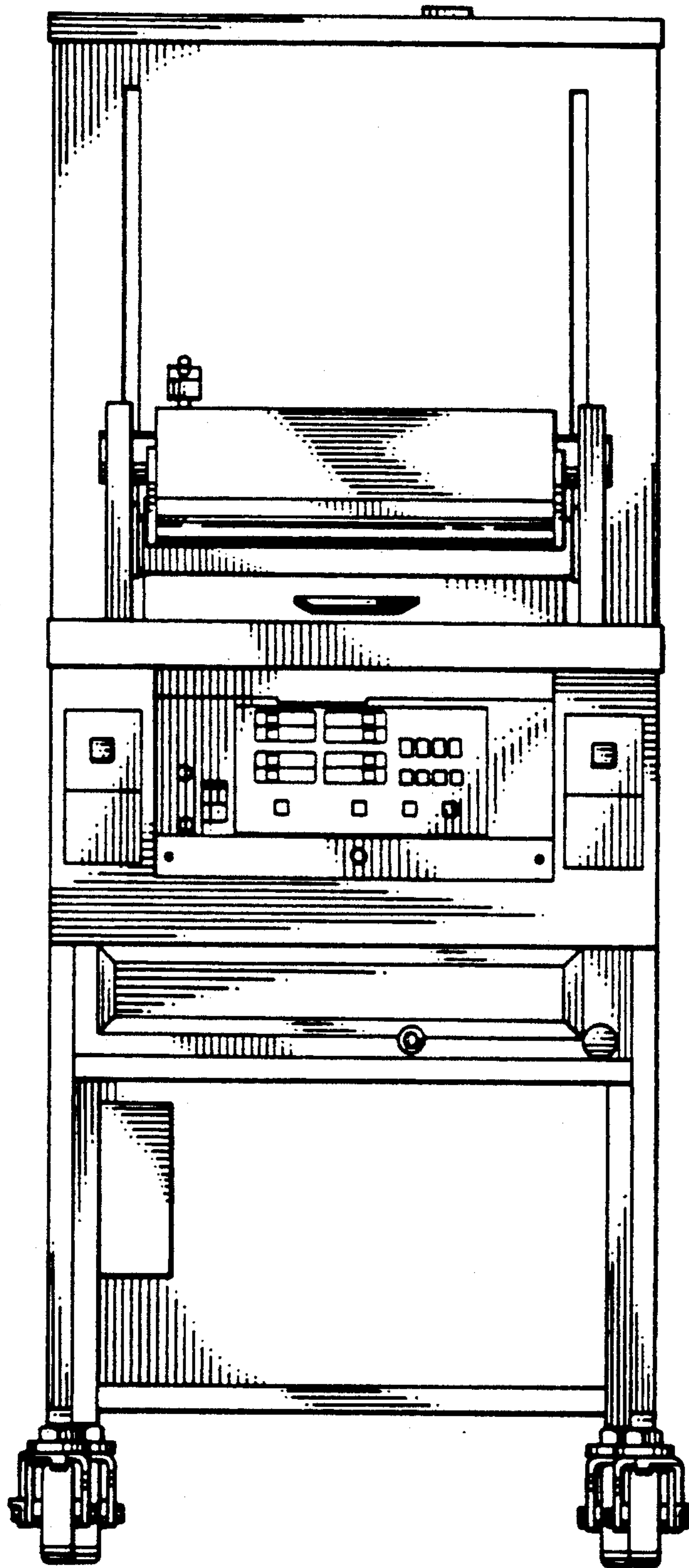

FIG. 7



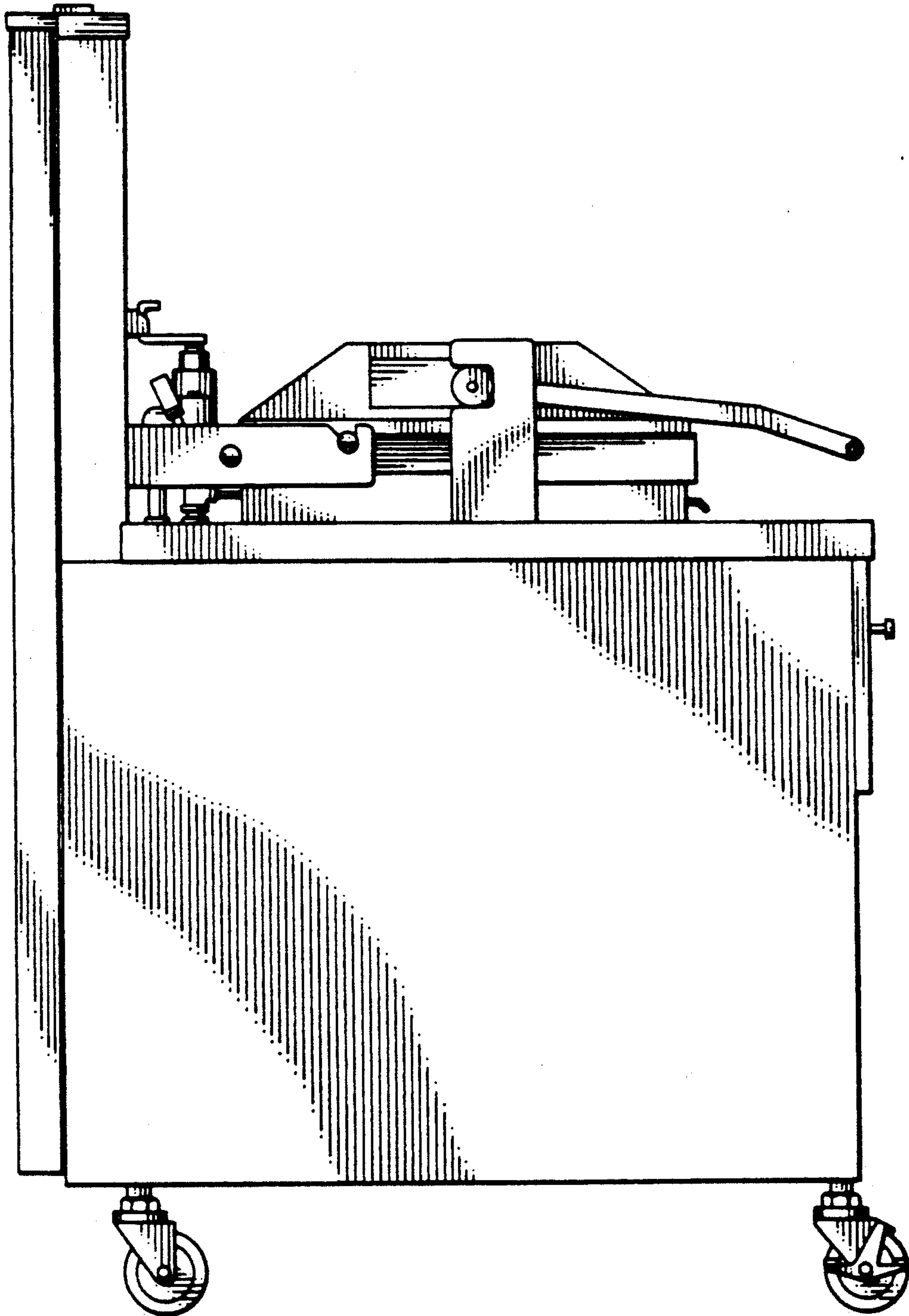

FIG. 8

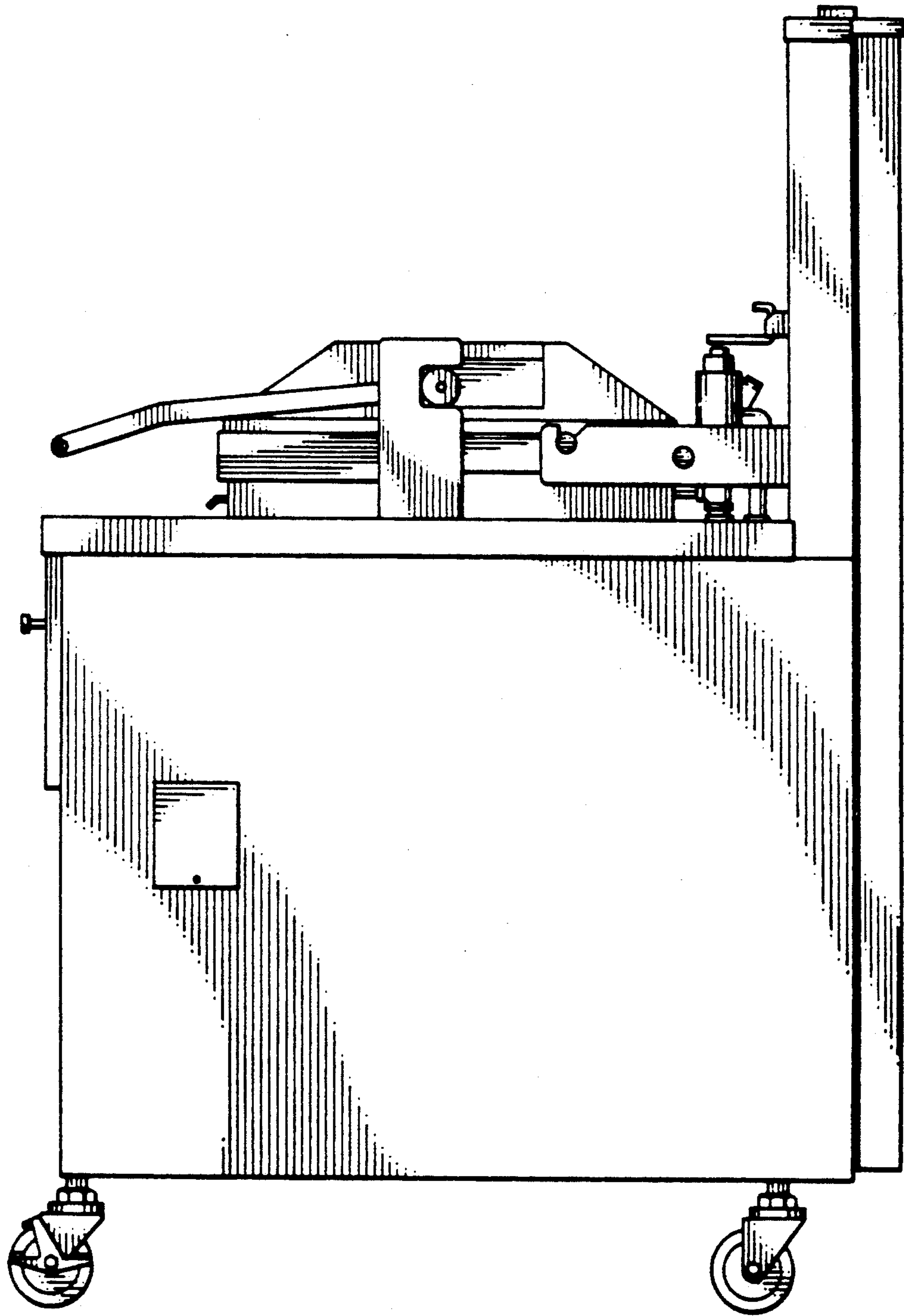

FIG. 9

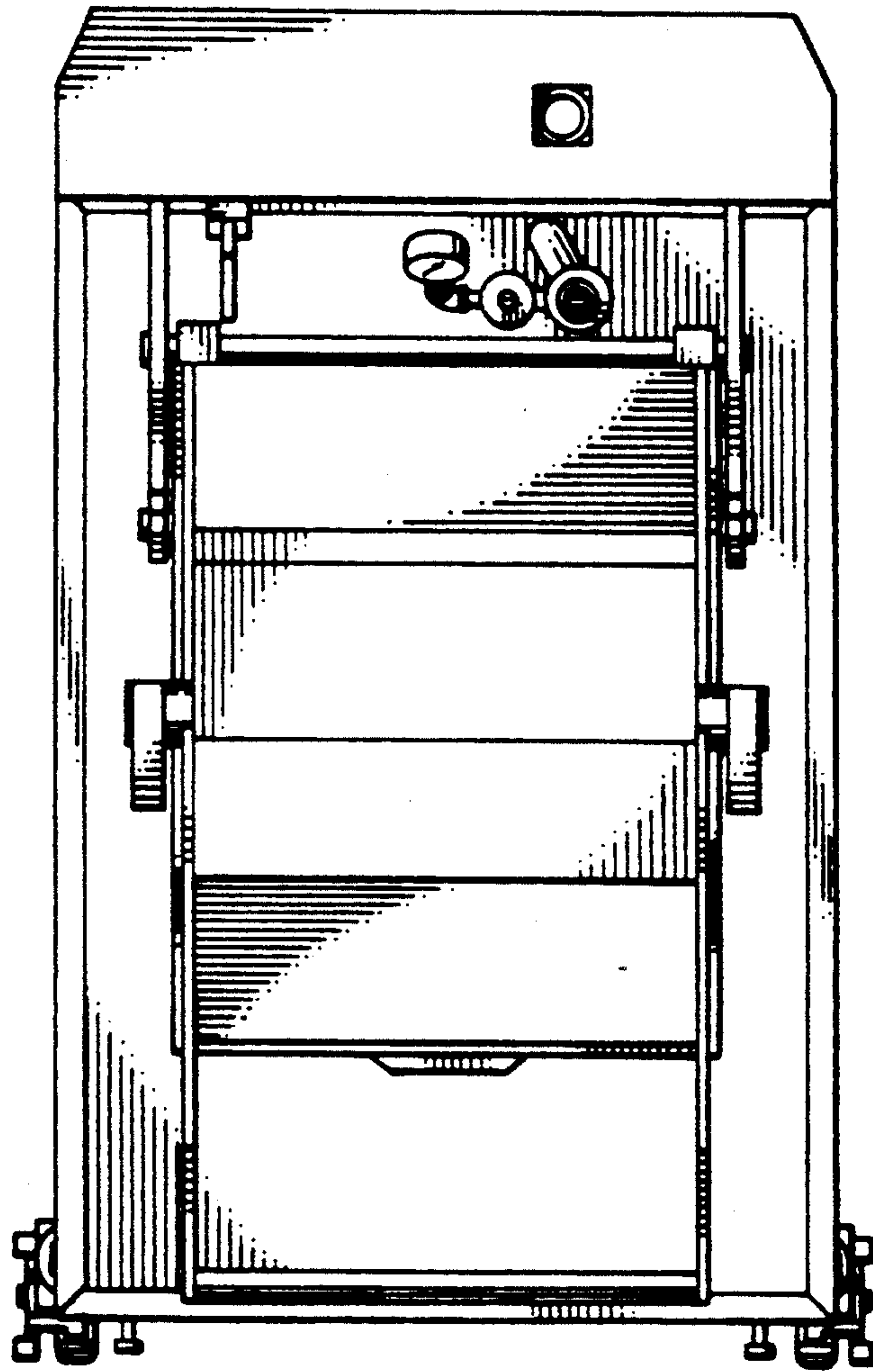

FIG. 10

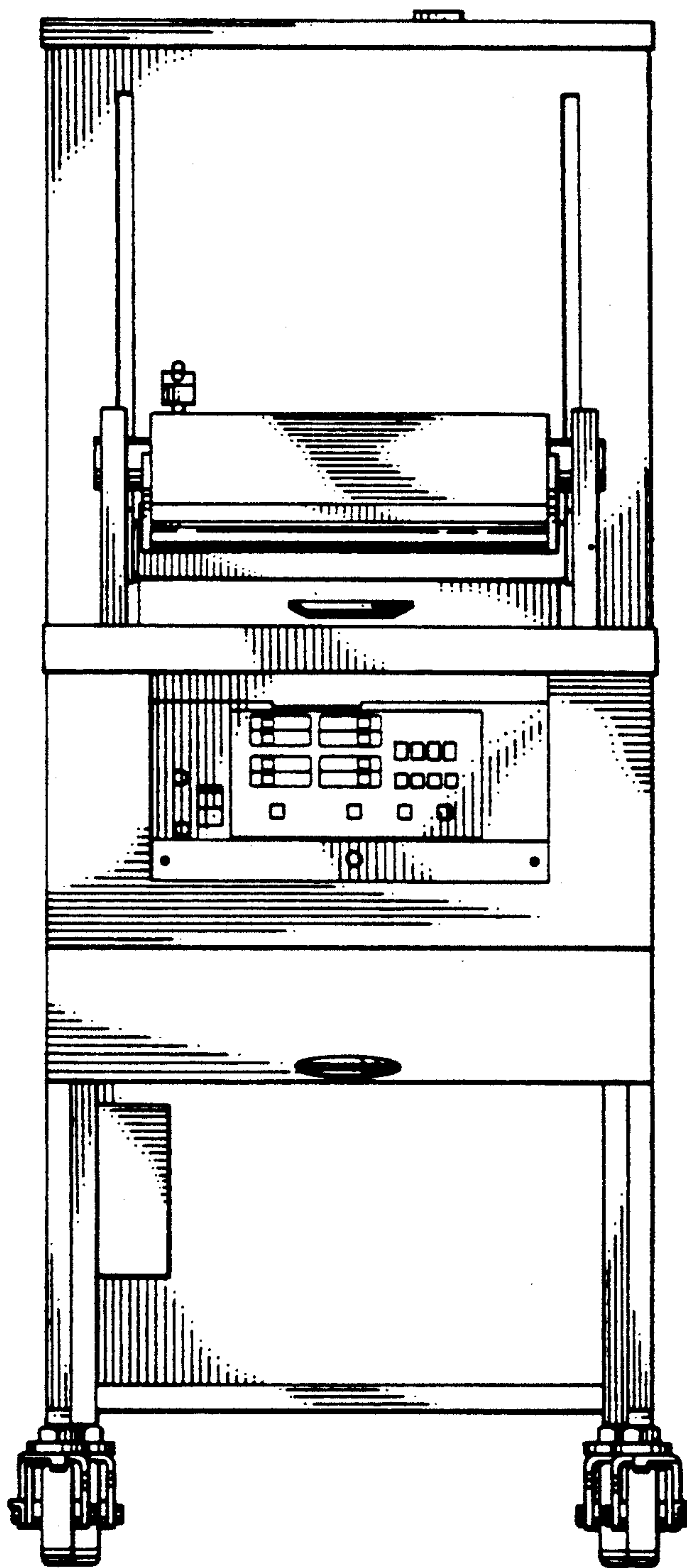

FIG. 11

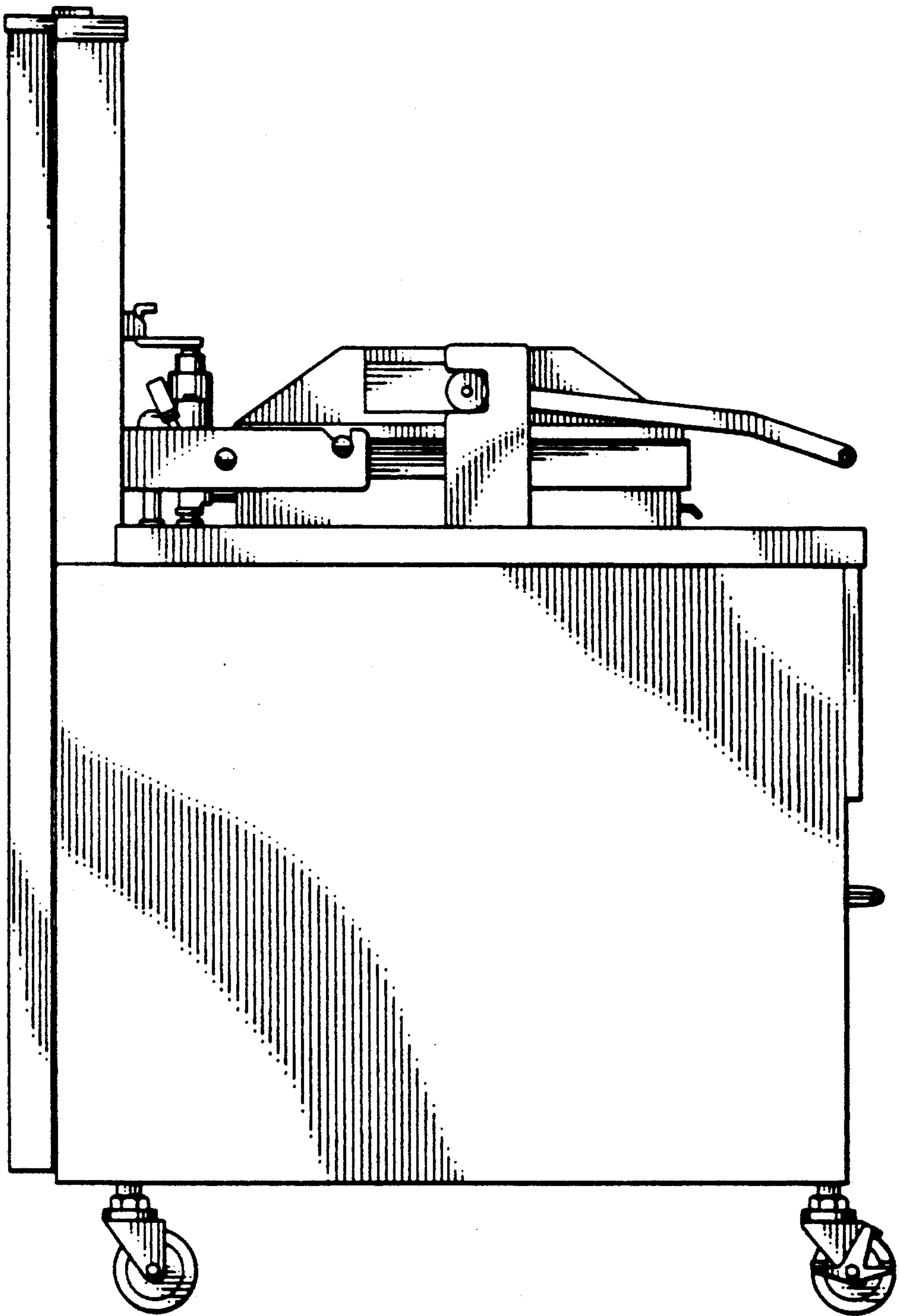

FIG. 12



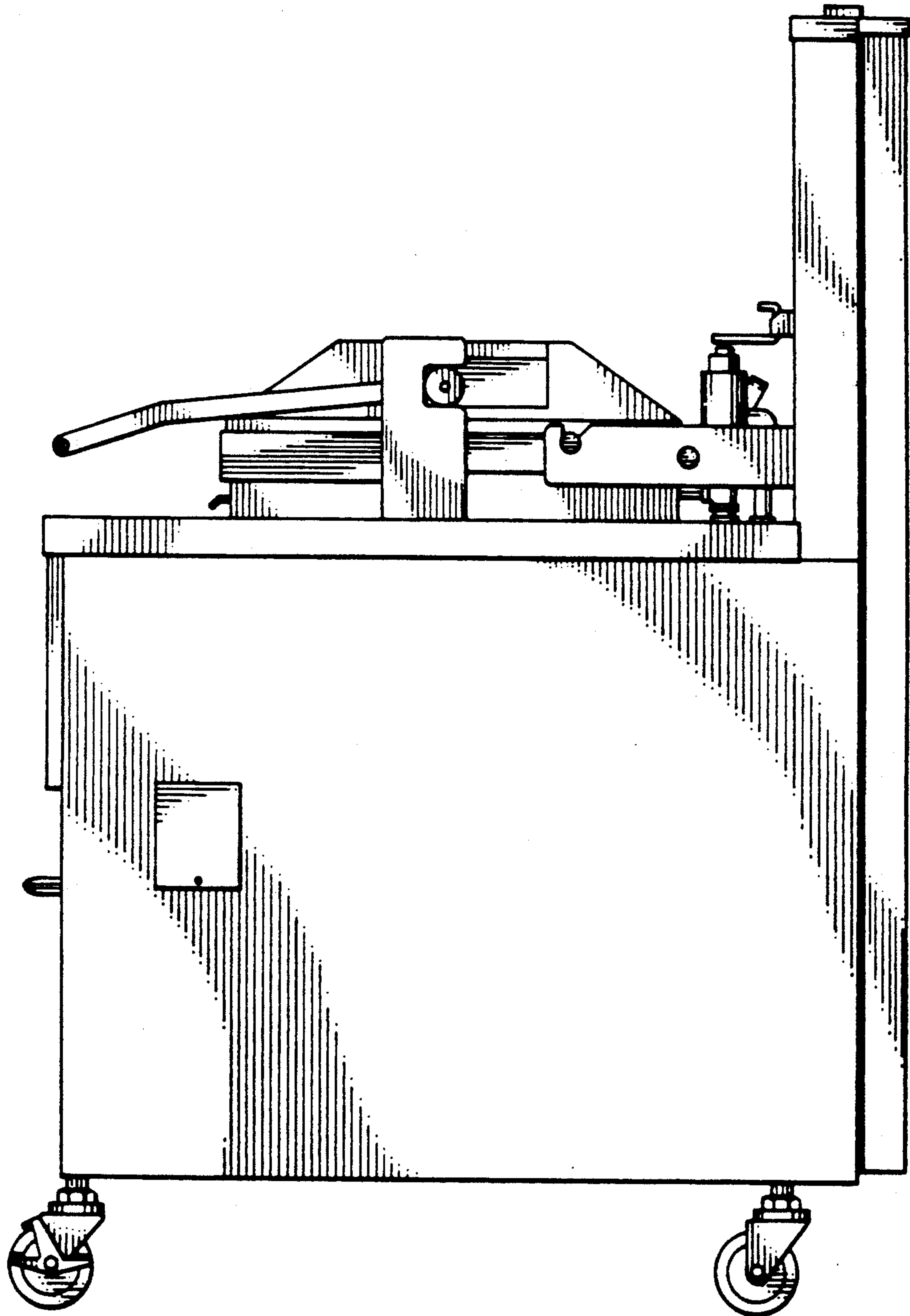

FIG. 13

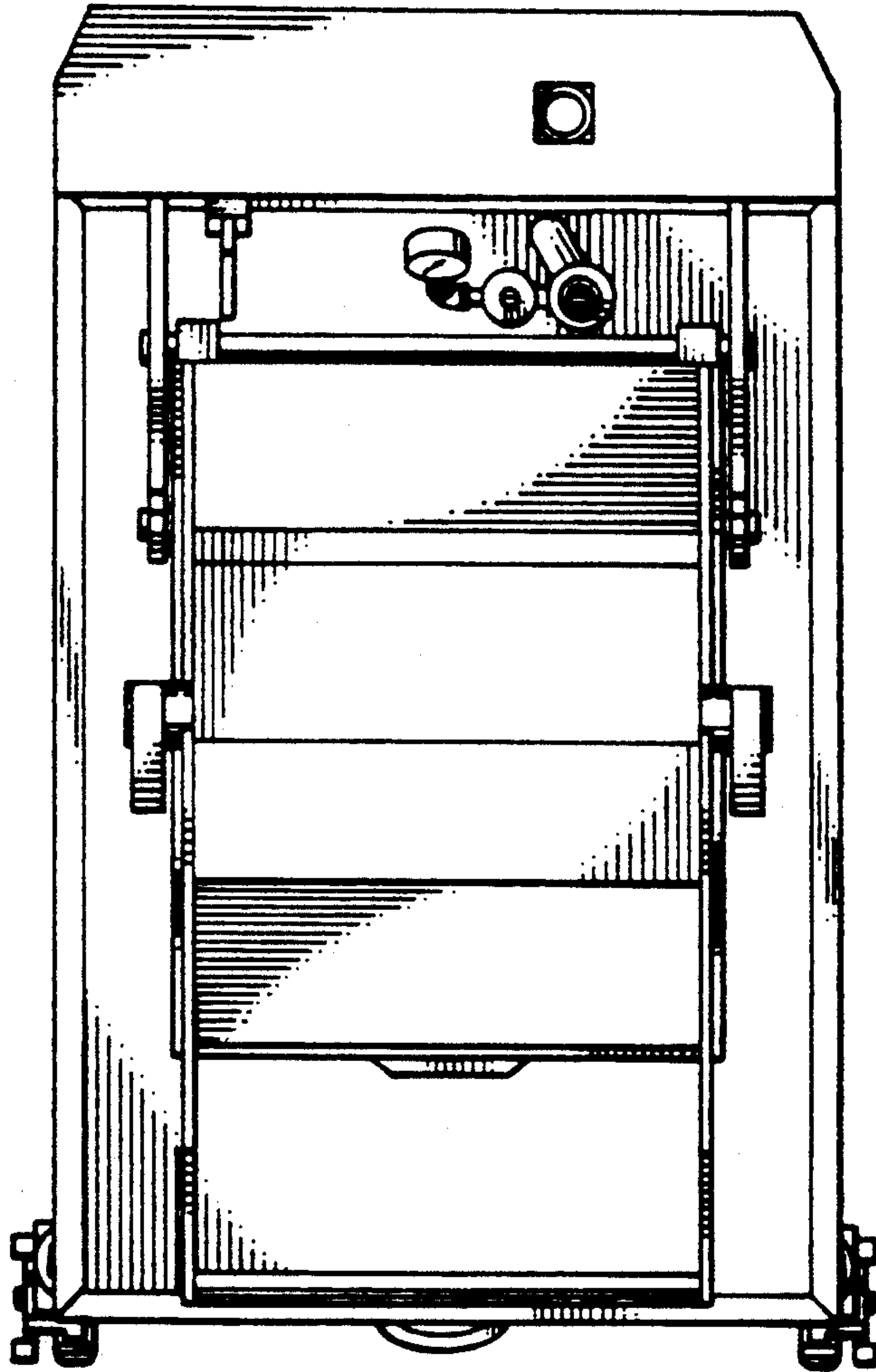

FIG. 14

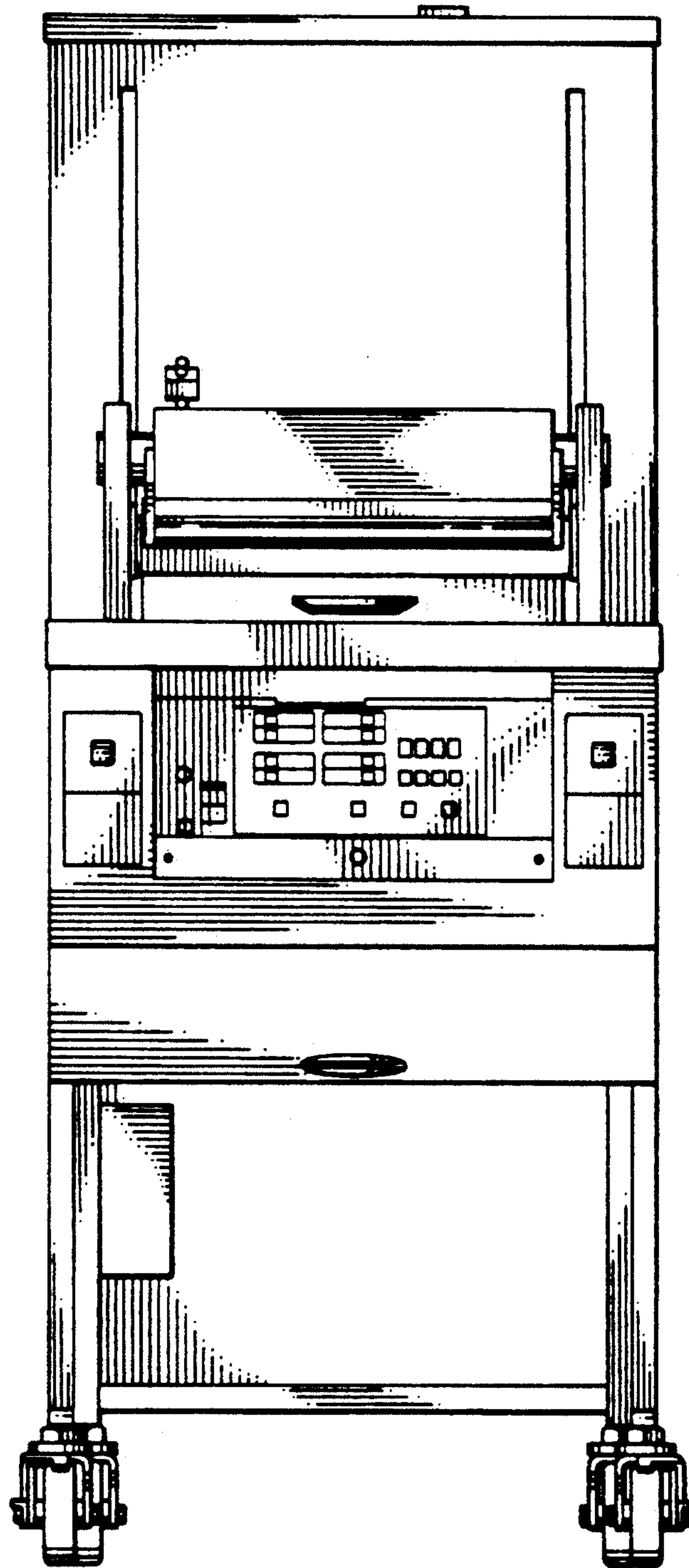

FIG. 15

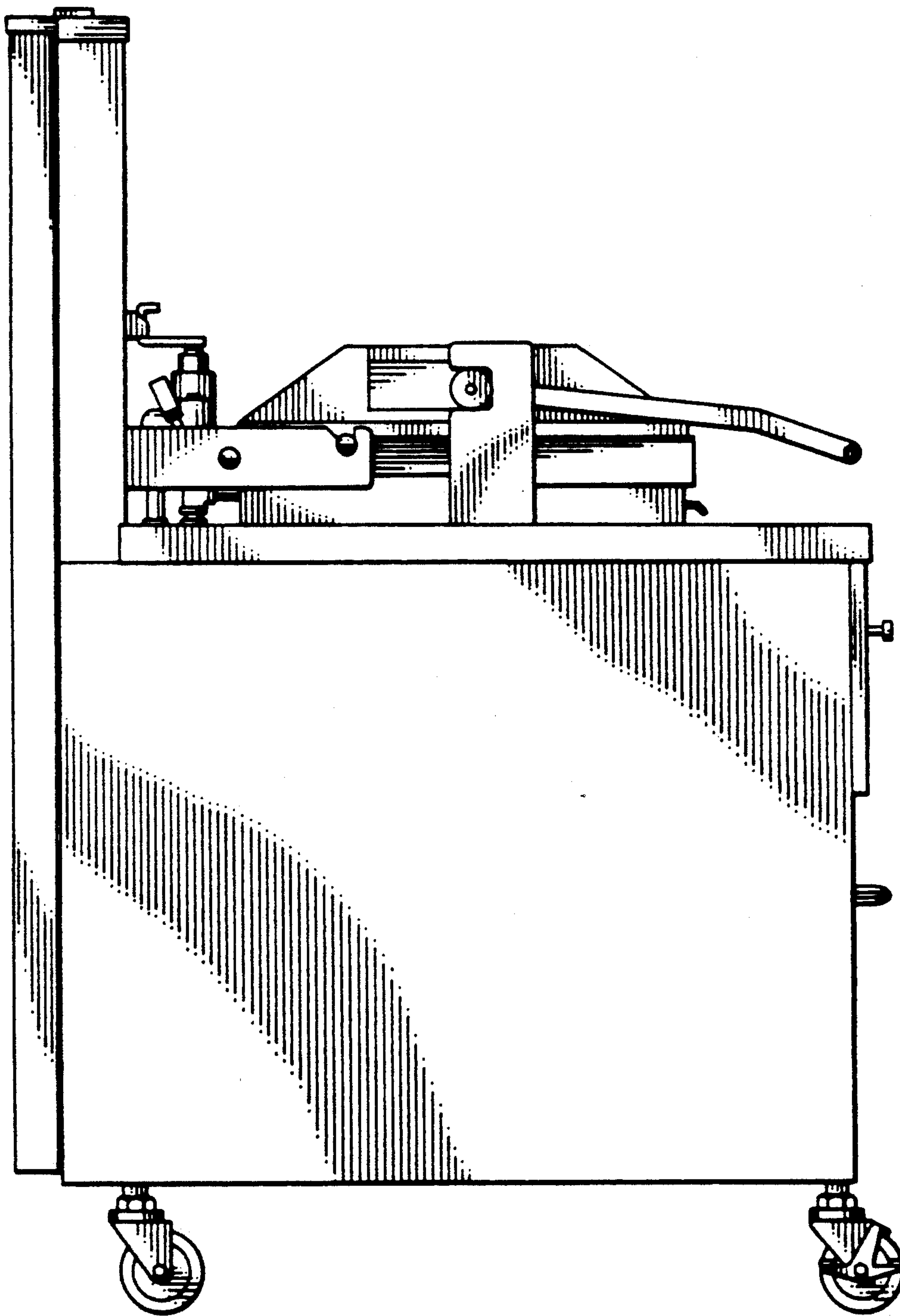

FIG. 16

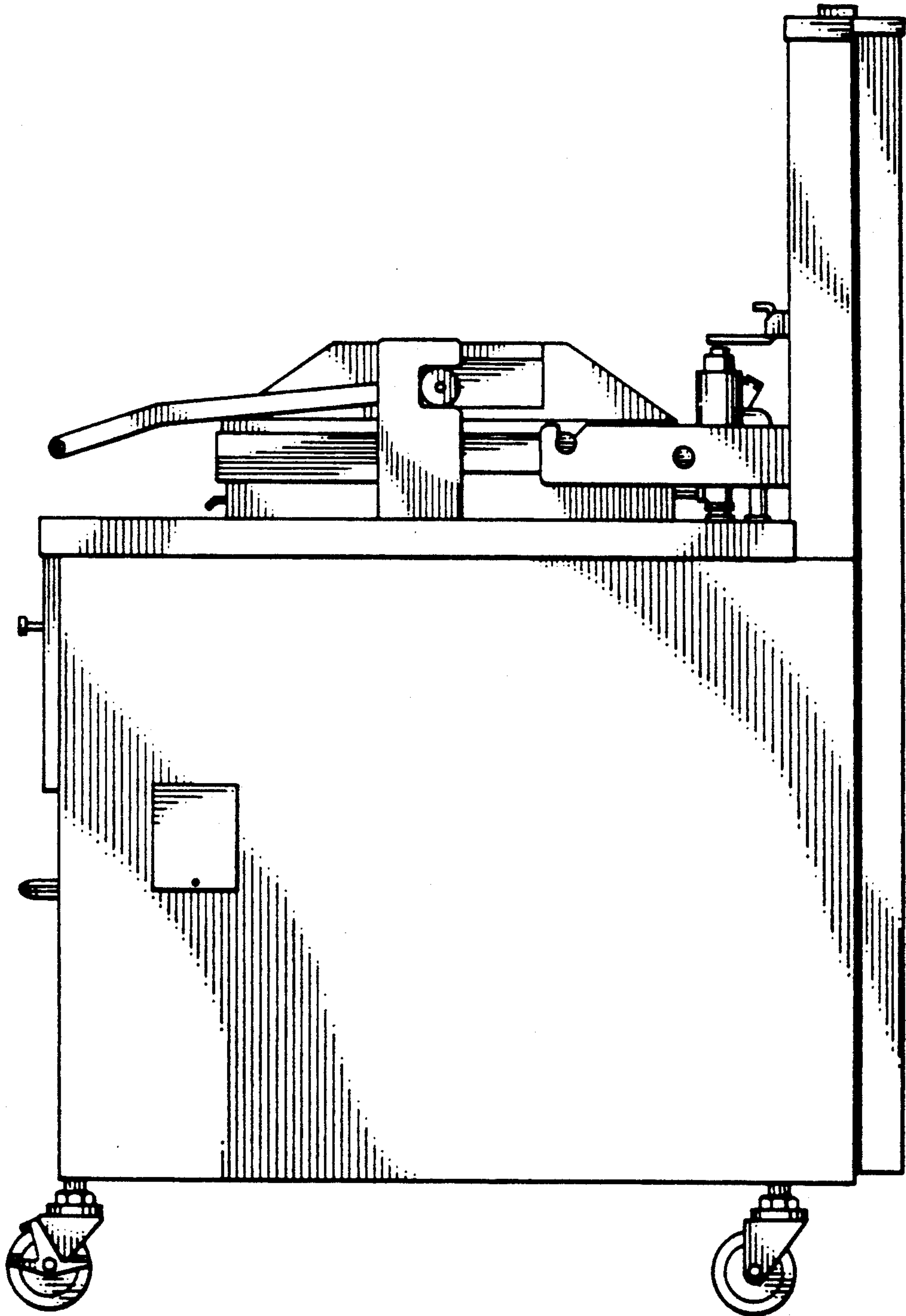

FIG. 17



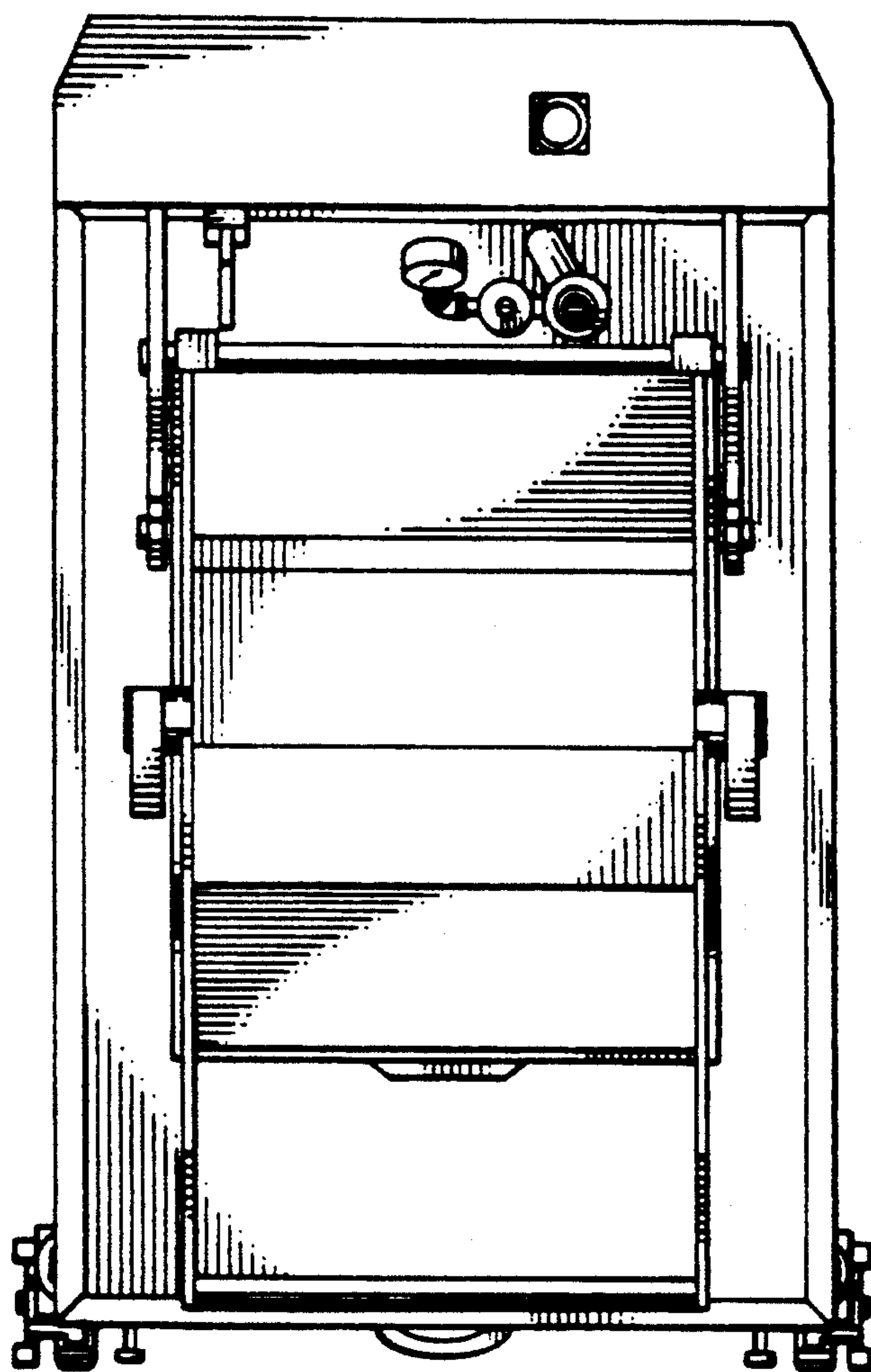

FIG. 18