



US00D336003S

United States Patent [19]

[11] Patent Number: **Des. 336,003**

Rocca et al.

[45] Date of Patent: **** Jun. 1, 1993**

[54] MACHINE FOR PREPARING BEVERAGES

[75] Inventors: **Enrico Rocca, Milan; Gianfranco Marsilli, Segrate, both of Italy**

[73] Assignee: **Luigi Lavazza SpA, Turin, Italy**

[**] Term: **14 Years**

[21] Appl. No.: **586,042**

[22] Filed: **Sep. 20, 1990**

[30] Foreign Application Priority Data

Mar. 20, 1990 [IT] Italy 52924-B/90

[52] U.S. Cl. **D7/309; D7/311**

[58] Field of Search **D7/300, 306, 309, 311; 99/279, 280, 288, 290, 292, 323.3, 307**

[56] References Cited

U.S. PATENT DOCUMENTS

D. 281,943 12/1985 Rosalino D7/309

D. 303,480 9/1989 Tsuji D7/309

4,579,050 4/1986 Niezen 99/307 X

OTHER PUBLICATIONS

Schoner Wohnen; Oct. 1984, p. 113; Girmi Coffeconcerto.

Primary Examiner—Alan P. Douglas
Assistant Examiner—Caron D. Veynar
Attorney, Agent, or Firm—Sughrue, Mion, Zinn, Macpeak & Seas

[57] CLAIM

The ornamental design for a machine for preparing beverages, as shown.

DESCRIPTION

FIG. 1 is a front elevational view of a machine for preparing beverages showing my new design;

FIG. 2 is a right side view;

FIG. 3 is a top plan view;

FIG. 4 is a rear view;

FIG. 5 is a left side view;

FIG. 6 is a bottom plan view; and,

FIG. 7 is a perspective view.

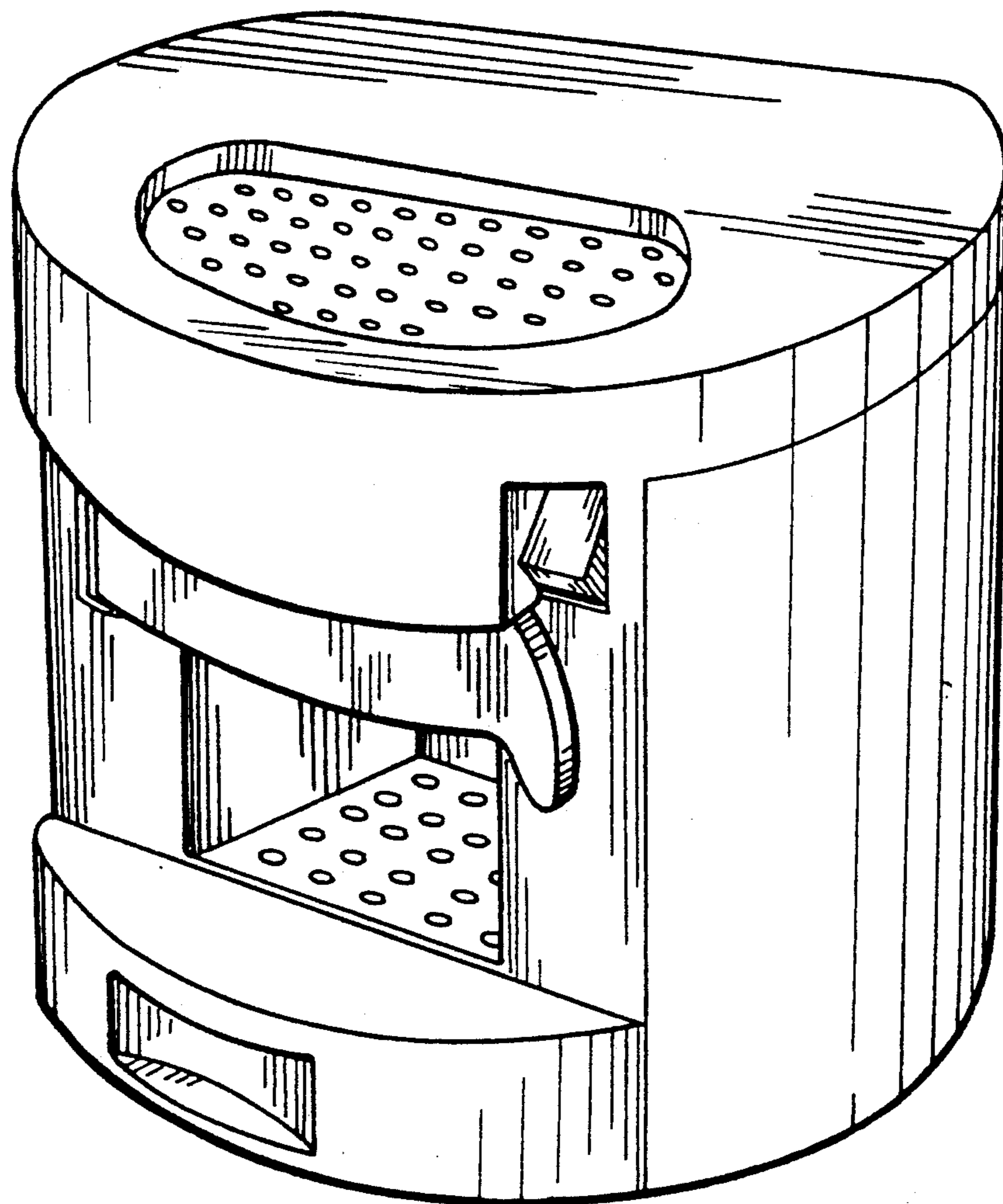

FIG. 3

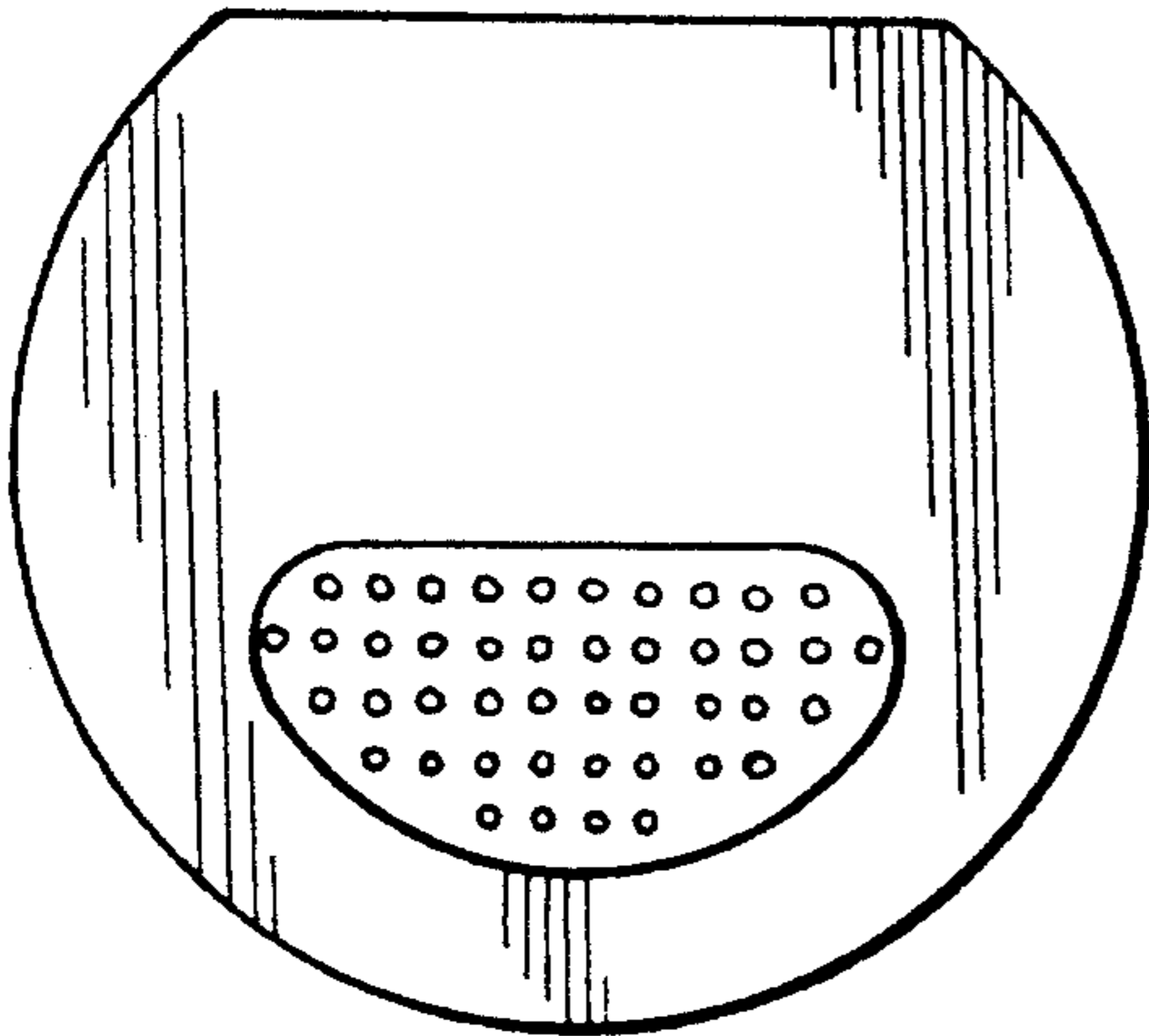

FIG. 1

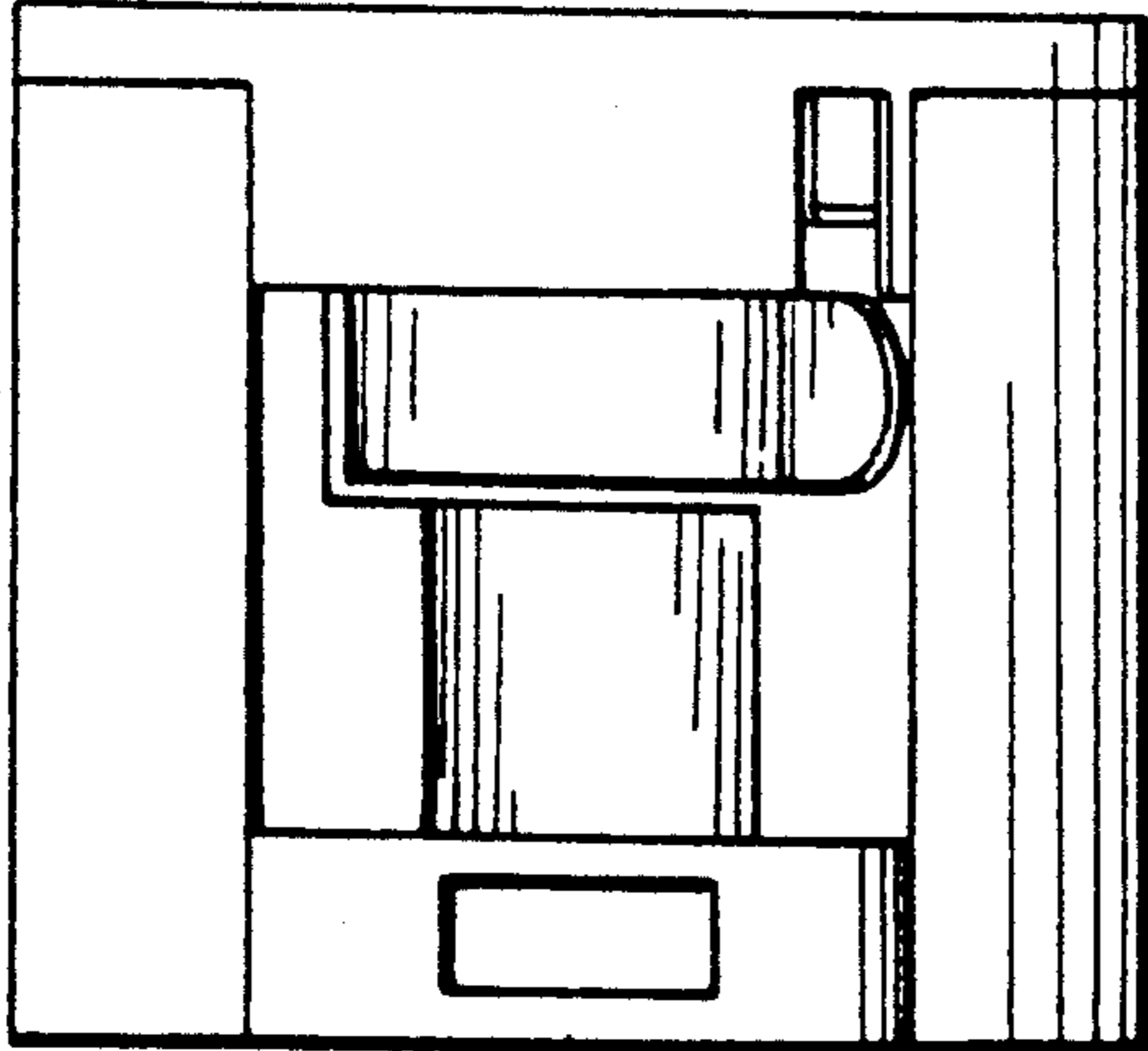

FIG. 2

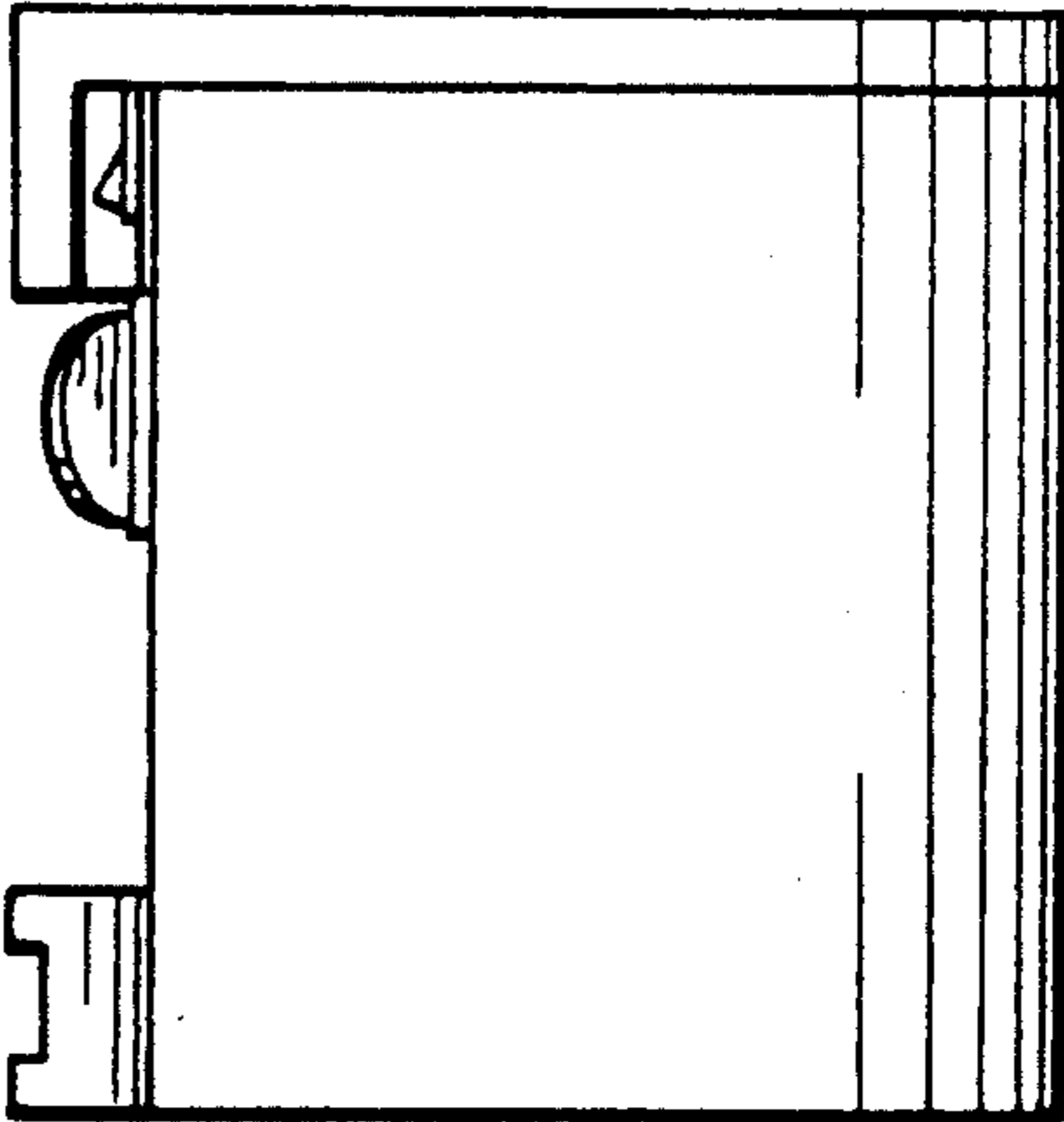

FIG. 4

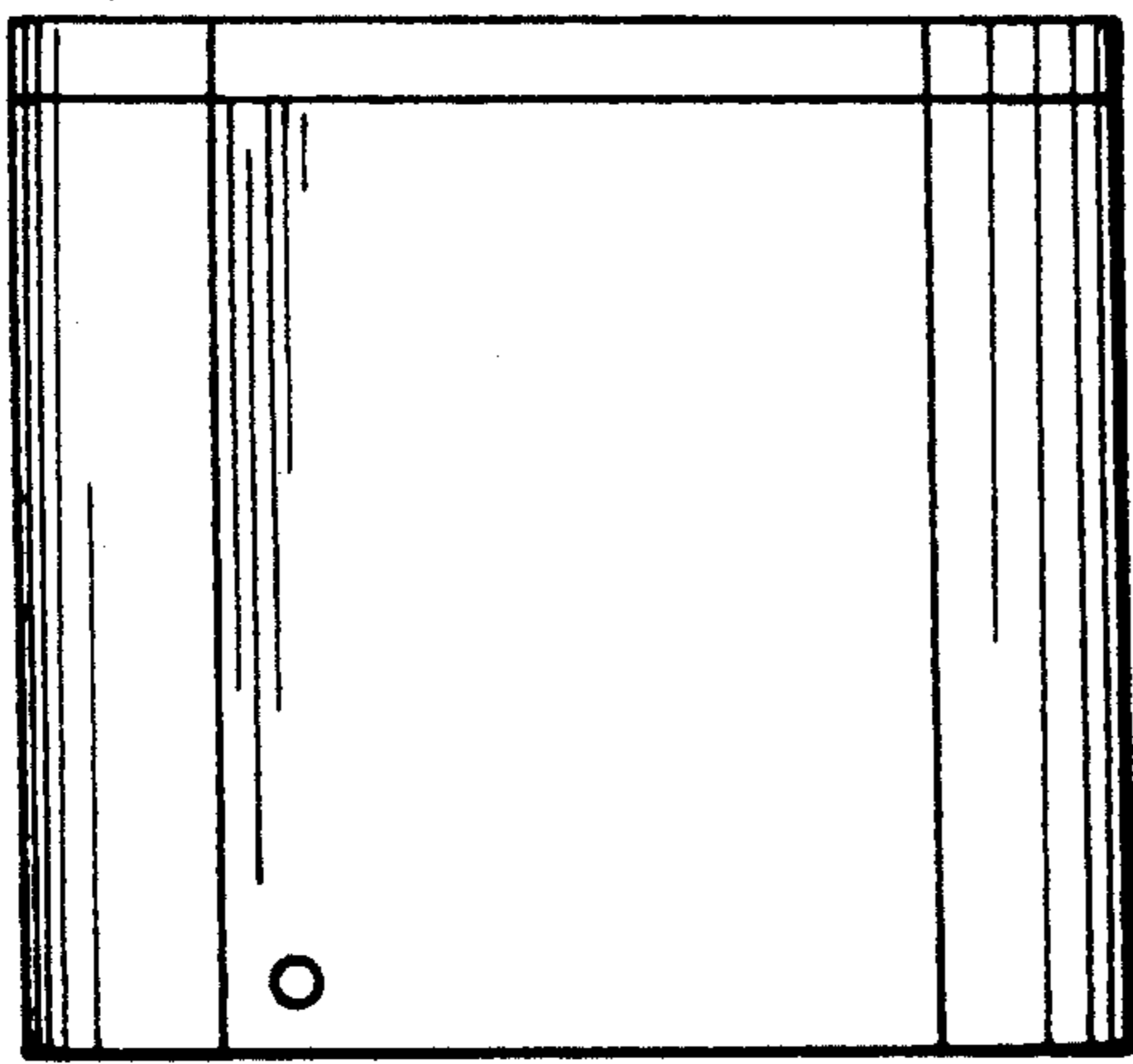

FIG. 5

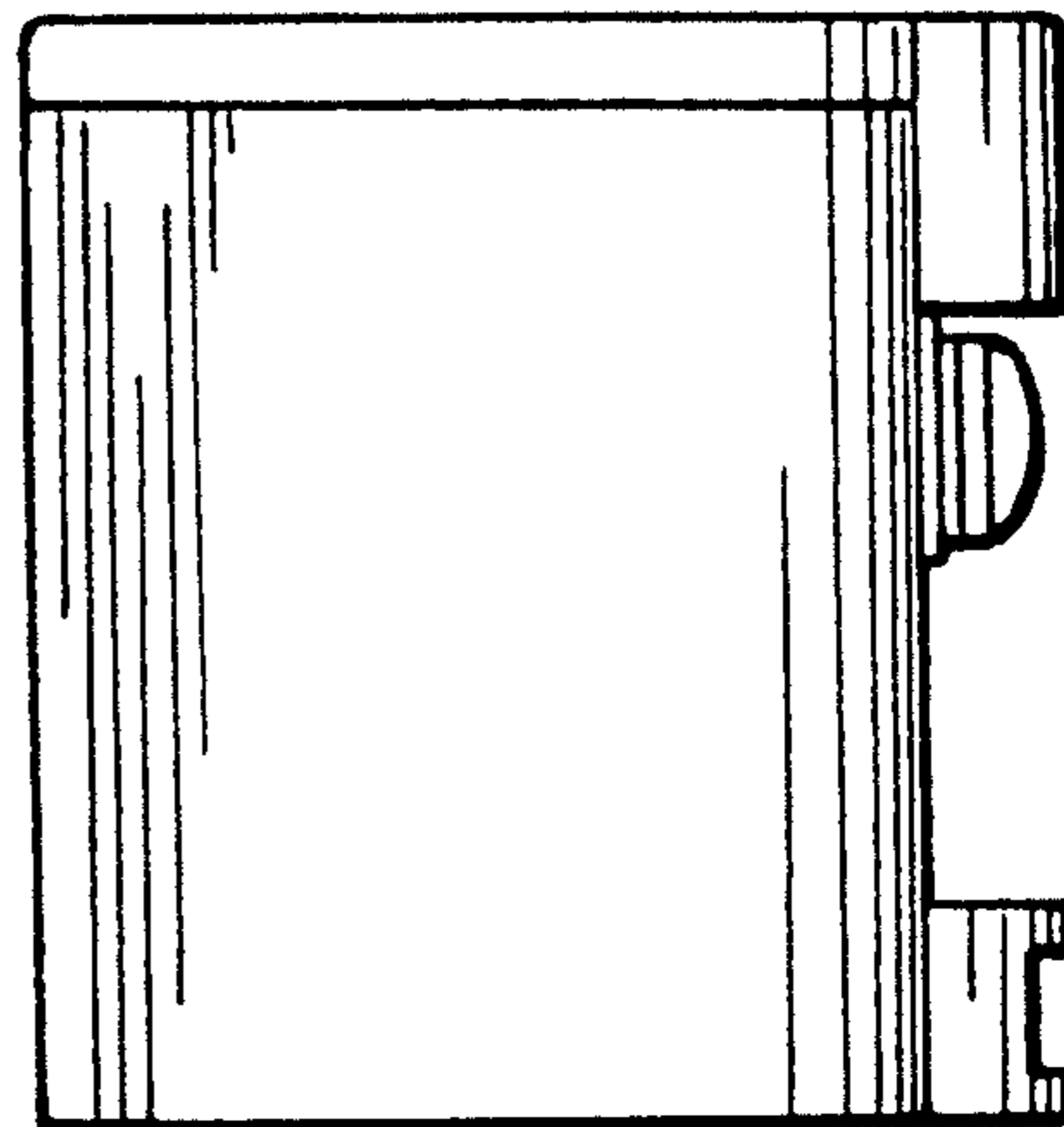

FIG. 6

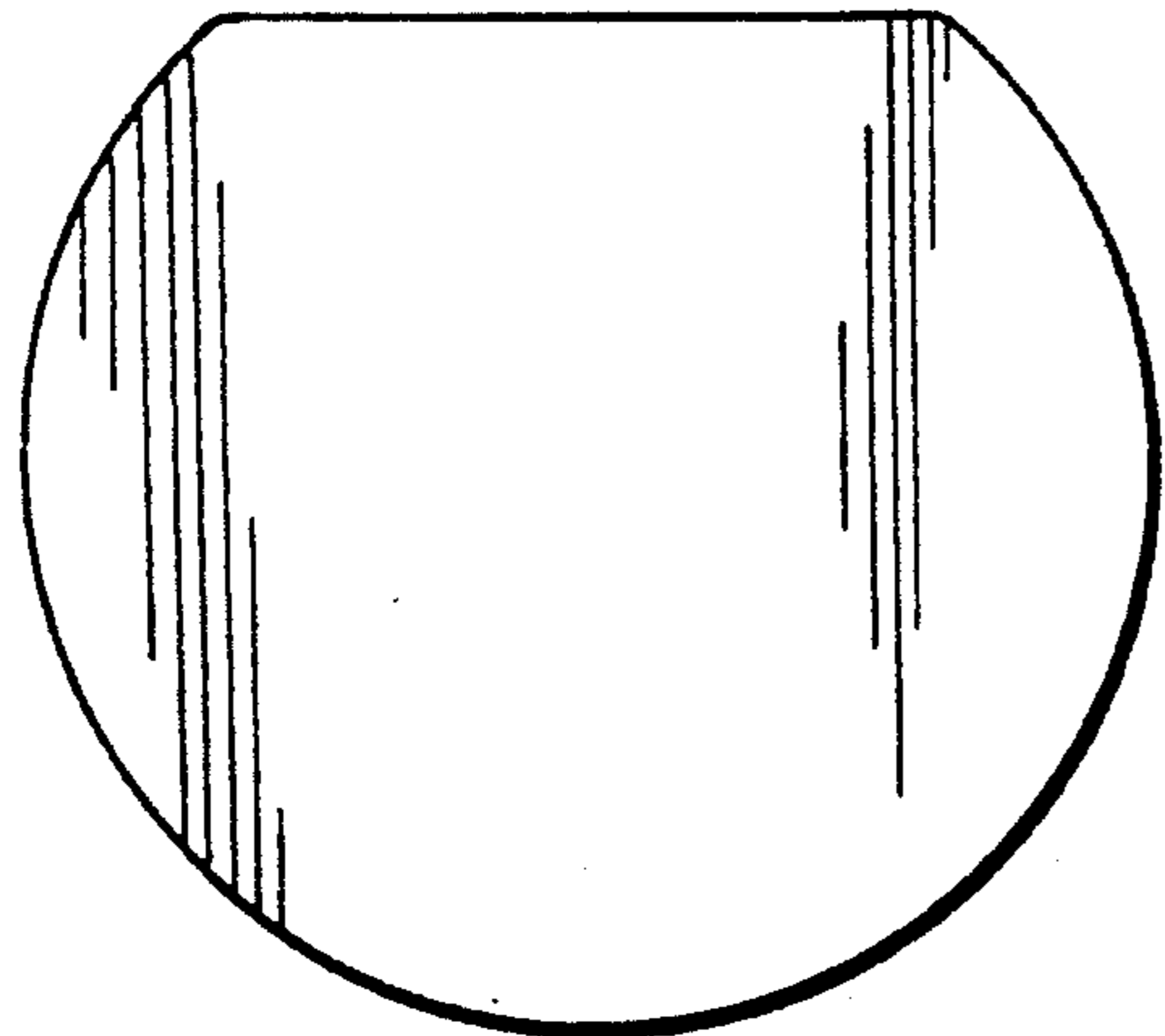

FIG. 7

