



US00D335941S

# United States Patent [19]

[11] Patent Number: **Des. 335,941**

Wright et al.

[45] Date of Patent: **\*\* May 25, 1993**

[54] **POWER NOZZLE FOR VACUUM CLEANER**

[75] Inventors: **Michael F. Wright, Cuyahoga Falls; Craig M. Saunders, Rocky River; Paul D. Stephens, Cleveland Heights; Mark E. Cipolla, Middlefield; Richard C. Farone, Wickliffe, all of Ohio**

[73] Assignee: **Royal Appliance Mfg. Co., Cleveland, Ohio**

[\*\*] Term: **14 Years**

[21] Appl. No.: **798,429**

[22] Filed: **Nov. 26, 1991**

[52] U.S. Cl. .... **D32/32**

[58] Field of Search ..... **D32/21, 22, 31-33, D32/38-39; 15/415.1, 418-419, 420, 422, 422.1, 354, 355, 358; 377/378, 323-326, 327.6, 335, 350-351, 361, 412**

[56] **References Cited**

**U.S. PATENT DOCUMENTS**

D. 262,708	1/1982	Essex	.....	D32/32
D. 263,236	3/1982	Ueda	.....	D32/32
D. 313,294	12/1990	Slany et al.	.....	D32/33
D. 314,264	1/1991	Kim	.....	D32/33

D. 314,265	1/1991	Hong	.....	D32/33
3,815,170	6/1974	Brooks et al.	.....	15/359
4,014,068	3/1977	Payne et al.	.....	15/355
4,397,058	8/1983	Koland	.....	15/325
4,706,327	11/1987	Getz et al.	.....	15/319
4,977,640	12/1990	Hirano et al.	.....	15/339
4,980,945	1/1991	Bewley	.....	15/339

*Primary Examiner*—A. Hugo Word  
*Assistant Examiner*—Ruth McInroy  
*Attorney, Agent, or Firm*—Fay, Sharpe, Beall, Fagan, Minnich & McKee

[57] **CLAIM**

The ornamental design for a power nozzle for vacuum cleaner, as shown and described.

**DESCRIPTION**

FIG. 1 is a perspective view of the power nozzle showing our new design;  
FIG. 2 is a top plan view of the power nozzle of FIG. 1;  
FIG. 3 is a front elevational view thereof;  
FIG. 4 is a rear elevational view thereof;  
FIG. 5 is a bottom plan view thereof;  
FIG. 6 is a side elevational view taken from the left side of the power nozzle of FIG. 1; and,  
FIG. 7 is a side elevational view taken from the right side of the power nozzle of FIG. 1.

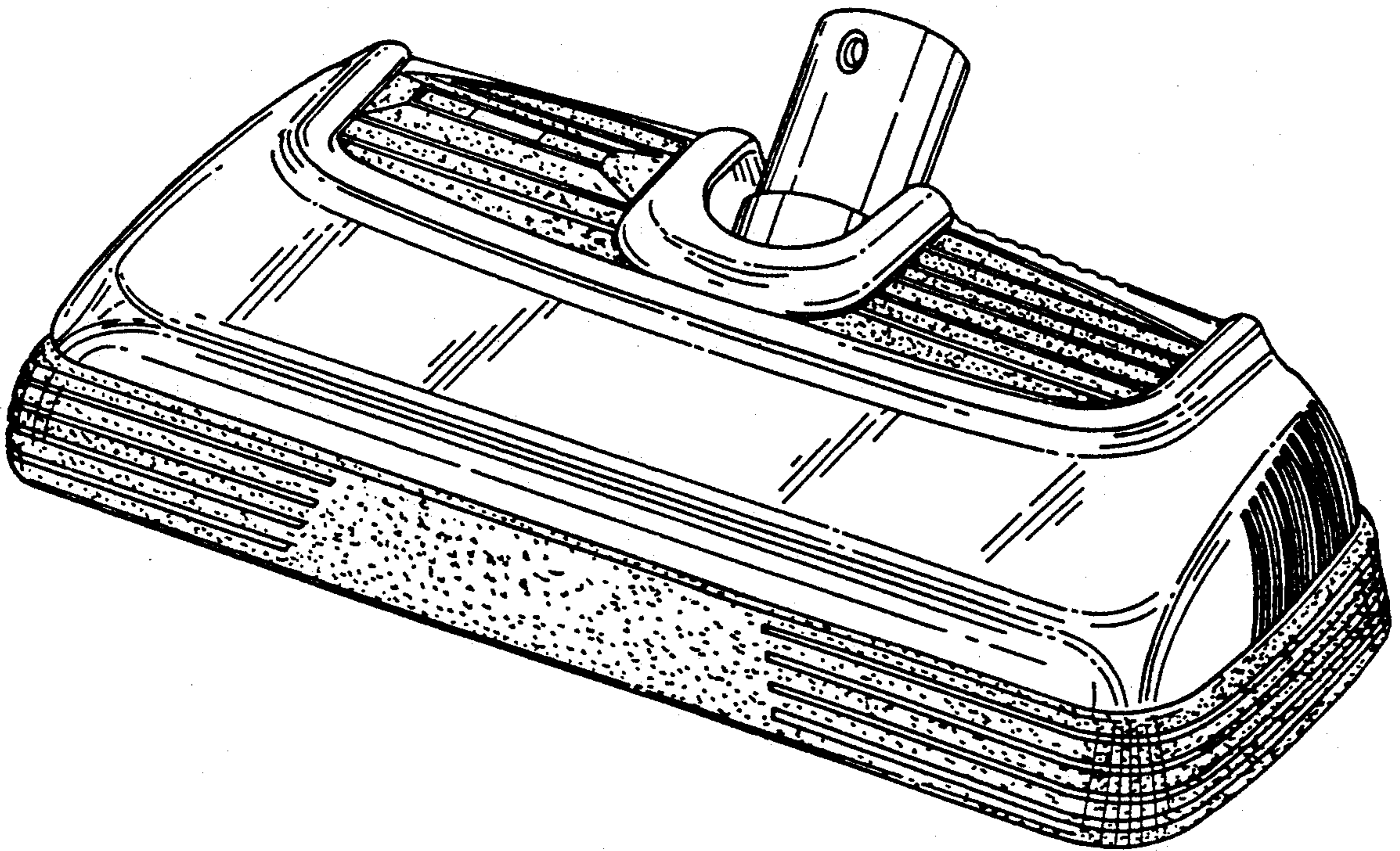

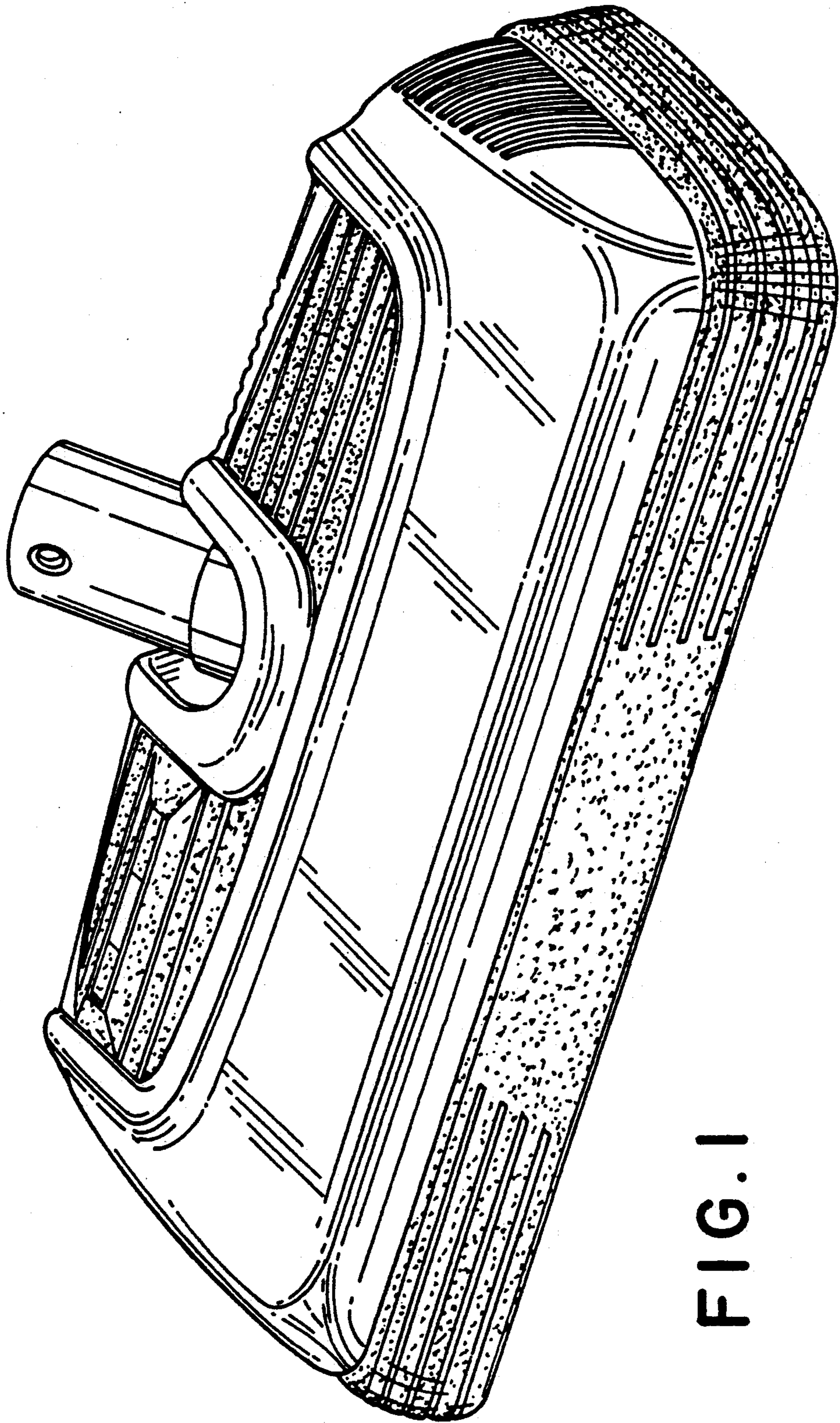

FIG. 1

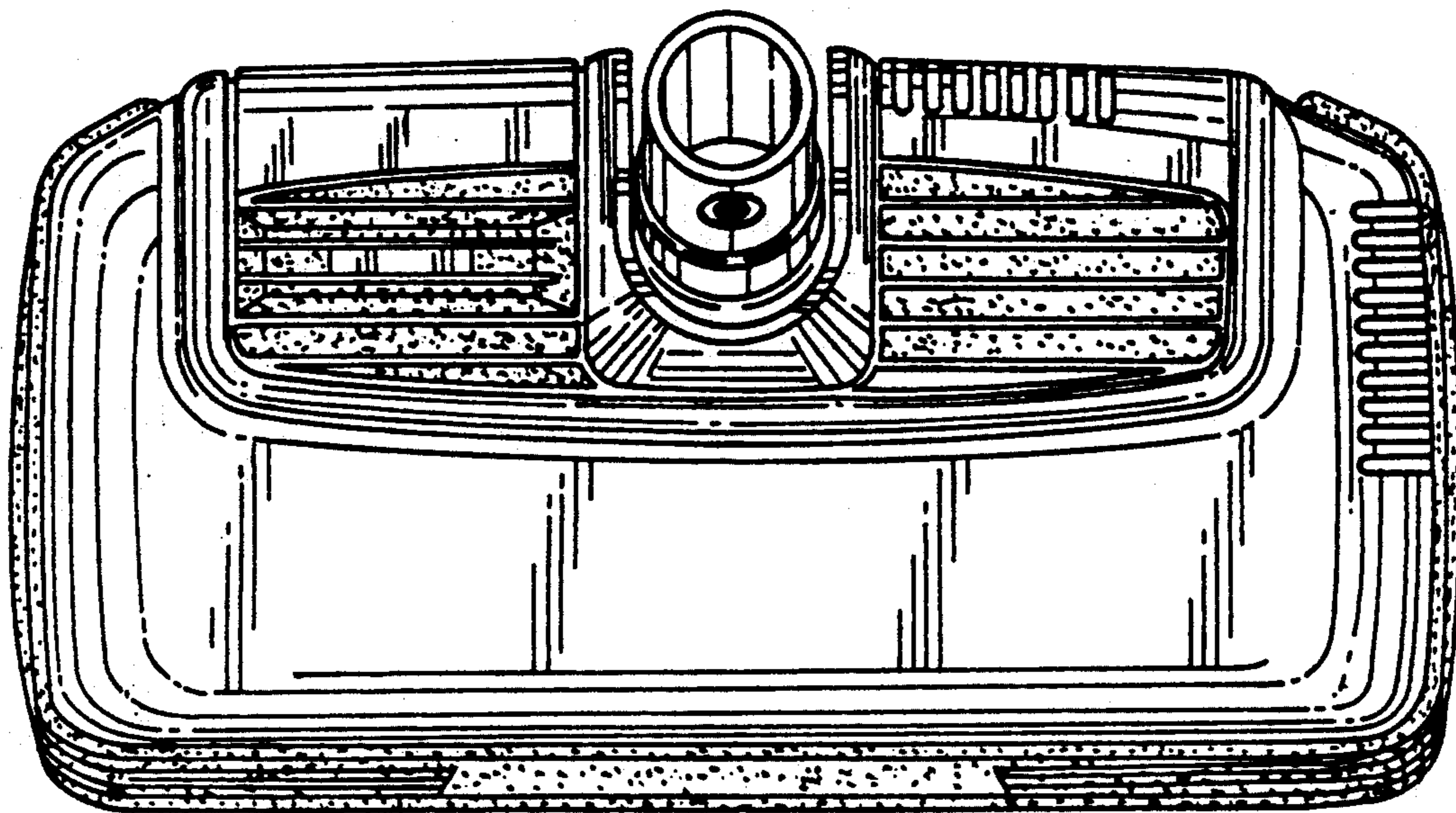

FIG. 2

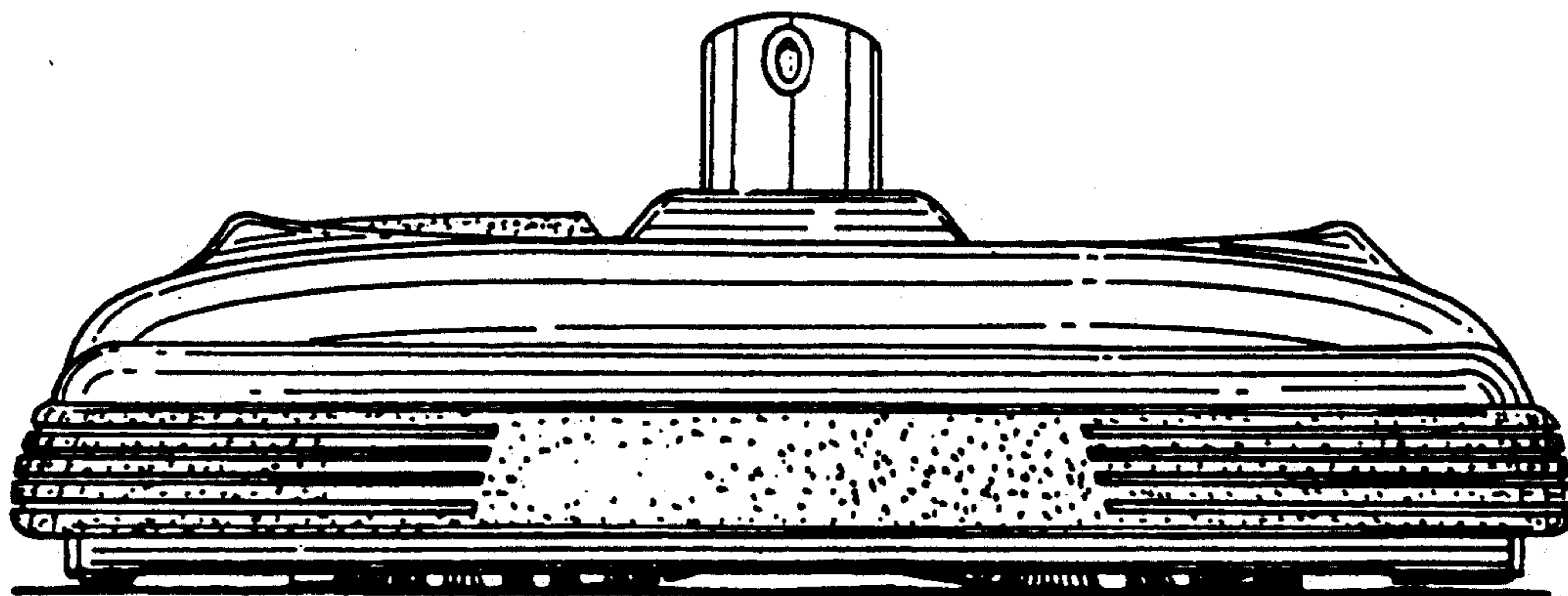

FIG. 3

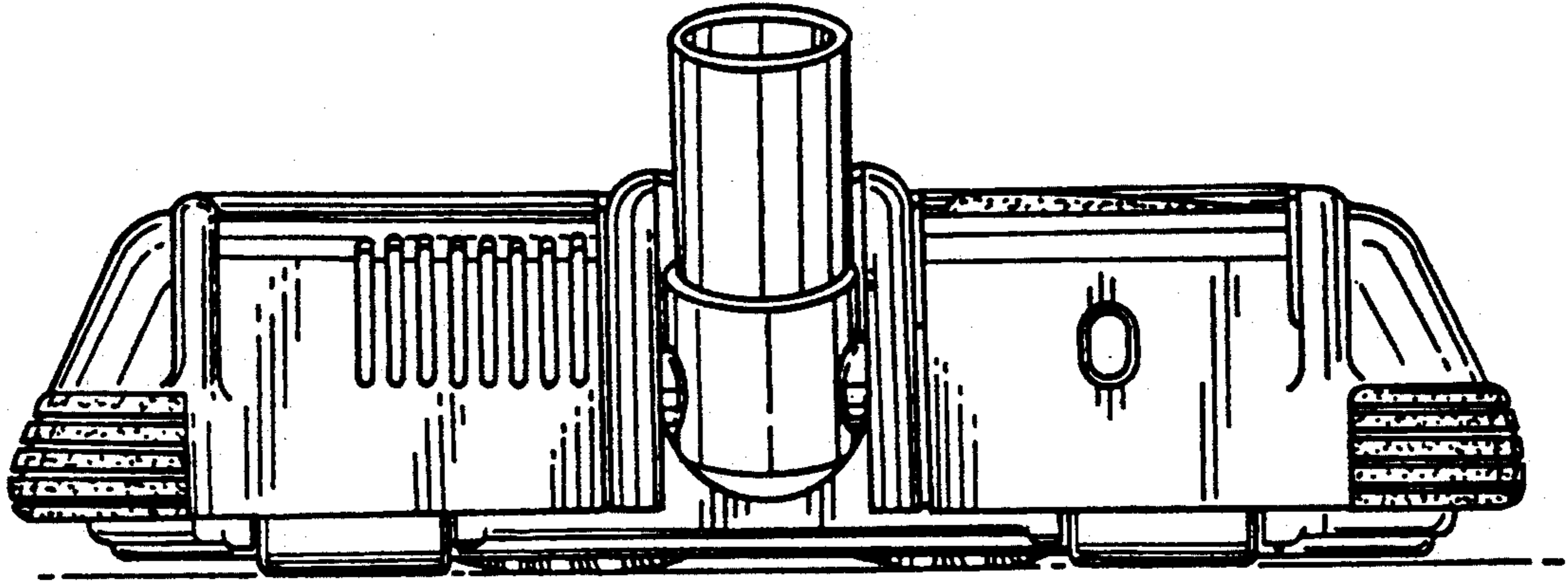

FIG. 4

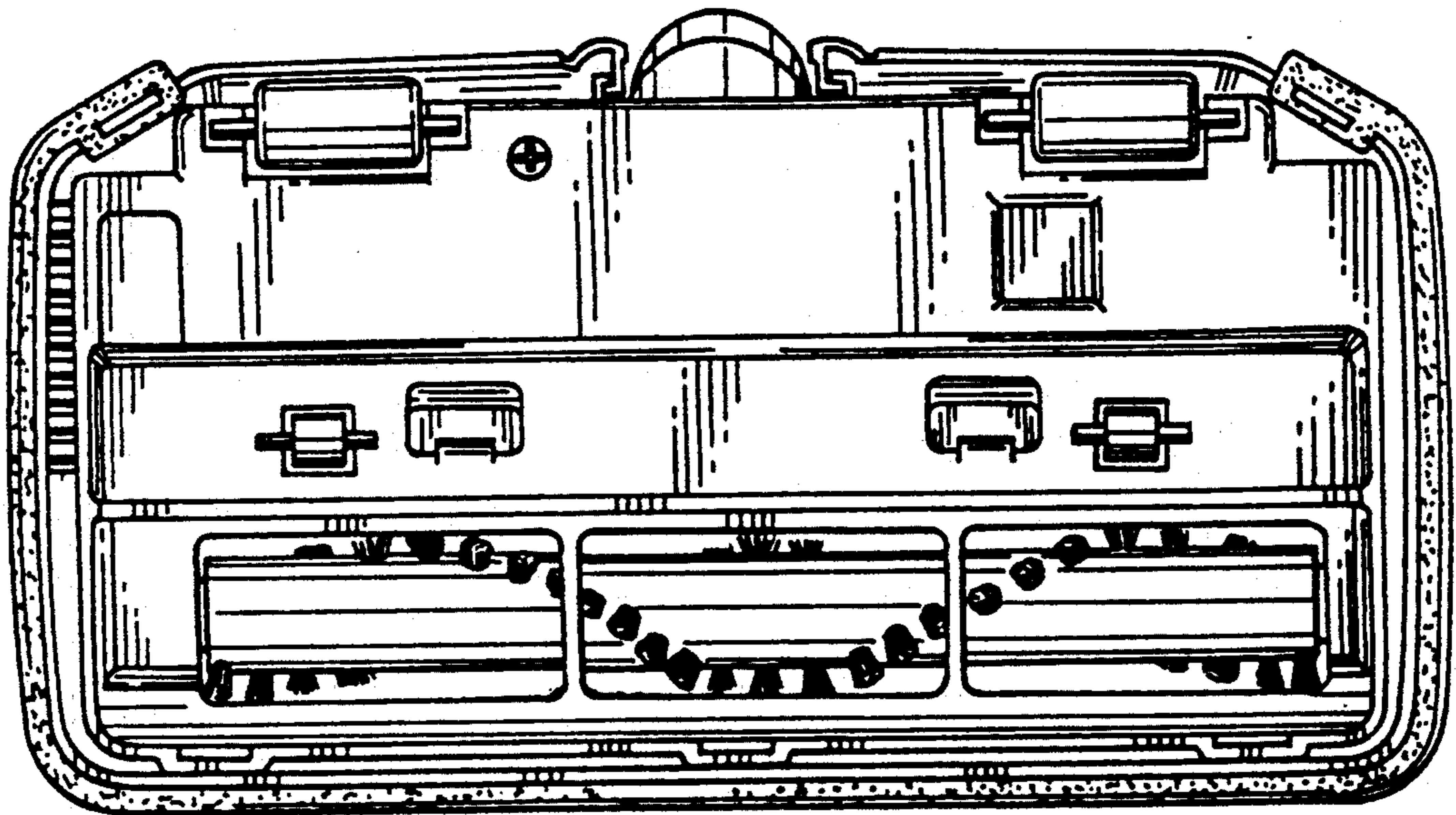

FIG. 5

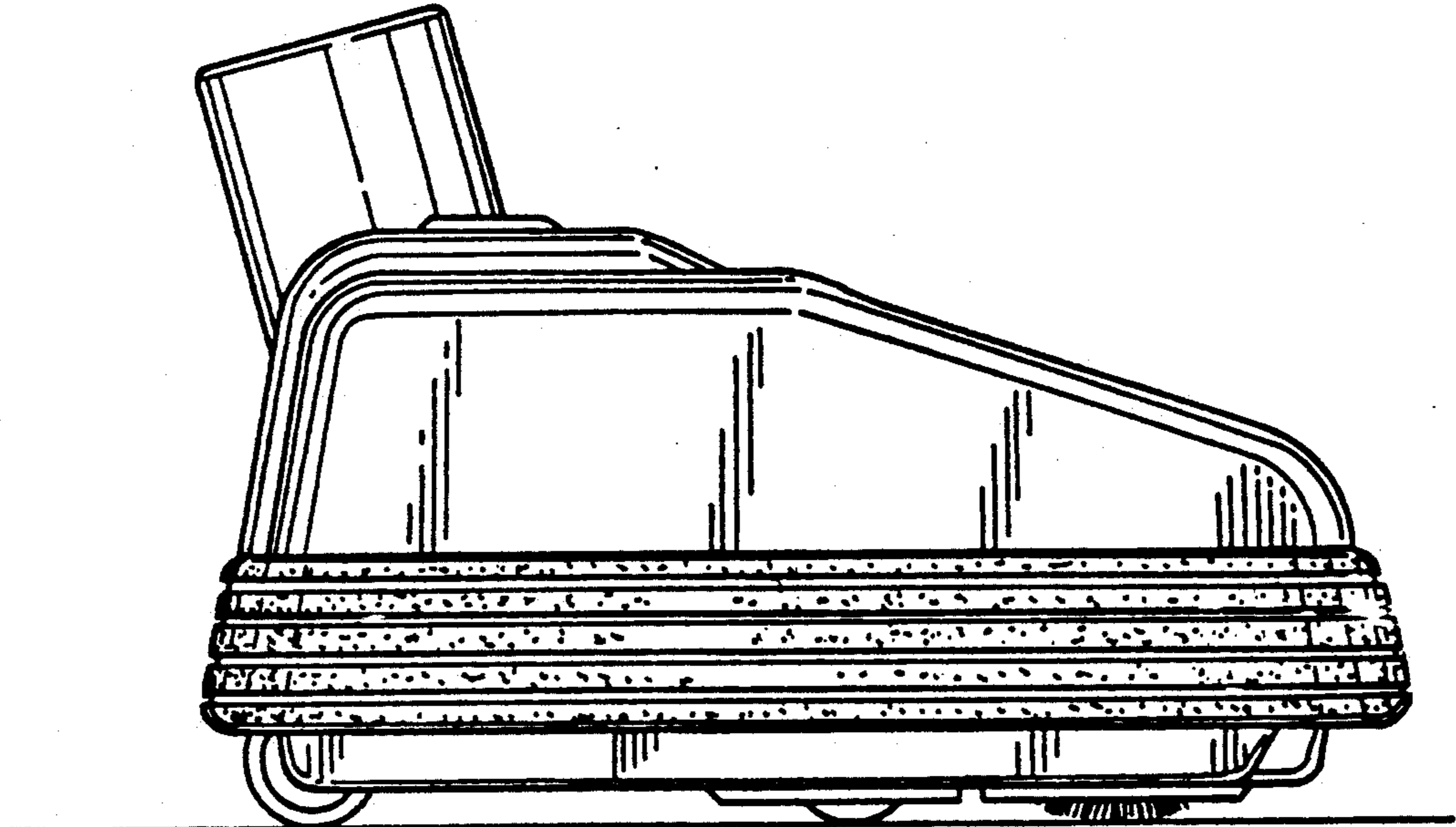

FIG. 6

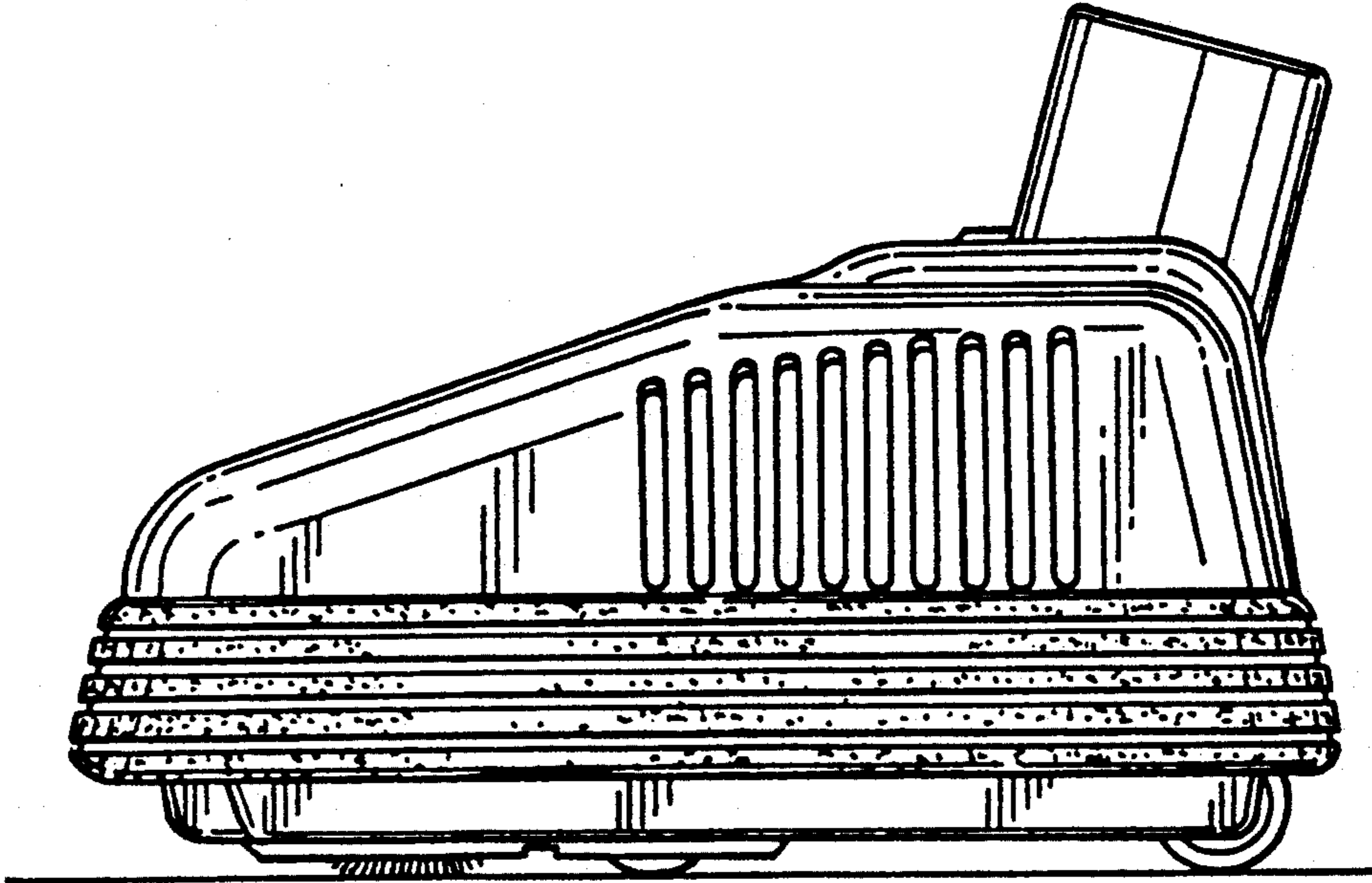

FIG. 7