



US00D335911S

United States Patent [19] Militello

[11] Patent Number: **Des. 335,911**

[45] Date of Patent: **** May 25, 1993**

[54] **REVOLVER CYLINDER RELEASE LEVER**

4,769,936 9/1988 Miller 42/66
4,894,939 1/1990 Perry 42/66

[76] Inventor: **Donald L. Militello, 4711 E. Angela Dr., Phoenix, Ariz. 85032**

Primary Examiner—A. Hugo Word
Assistant Examiner—Doris V. Coles
Attorney, Agent, or Firm—Leon Gilden

[**] Term: **14 Years**

[21] Appl. No.: **655,957**

[57] **CLAIM**

[22] Filed: **Feb. 15, 1991**

The practical design for a revolver cylinder release lever, as shown and described.

[52] U.S. Cl. **D22/108; D22/104**

[58] Field of Search **D22/108, 109; 42/62, 42/65, 66, 67**

DESCRIPTION

[56] **References Cited**

U.S. PATENT DOCUMENTS

1,518,027	12/1924	Vosmek	42/62
2,863,249	12/1958	Koucky et al.	42/66
2,927,390	3/1960	Lewis	42/67 X
3,221,433	12/1965	Lewis	42/65 X
3,387,399	6/1968	McClenahan	42/62
3,628,278	12/1971	Ruger	42/62
3,978,603	9/1976	Murabito	42/66
4,173,090	11/1979	Baker	42/67

FIG. 1 is a front elevational view of the revolver cylinder release lever showing my new design; FIG. 2 is a rear elevational view thereof; FIG. 3 is a left side elevational view thereof; FIG. 4 is a right side elevational view thereof; FIG. 5 is a top plan view thereof; FIG. 6 is a bottom plan view thereof; and, FIG. 7 is a perspective view thereof. The broken line showing of part of a revolver and a screw in FIG. 7 is for illustrative purposes only and forms no part of the claimed design.

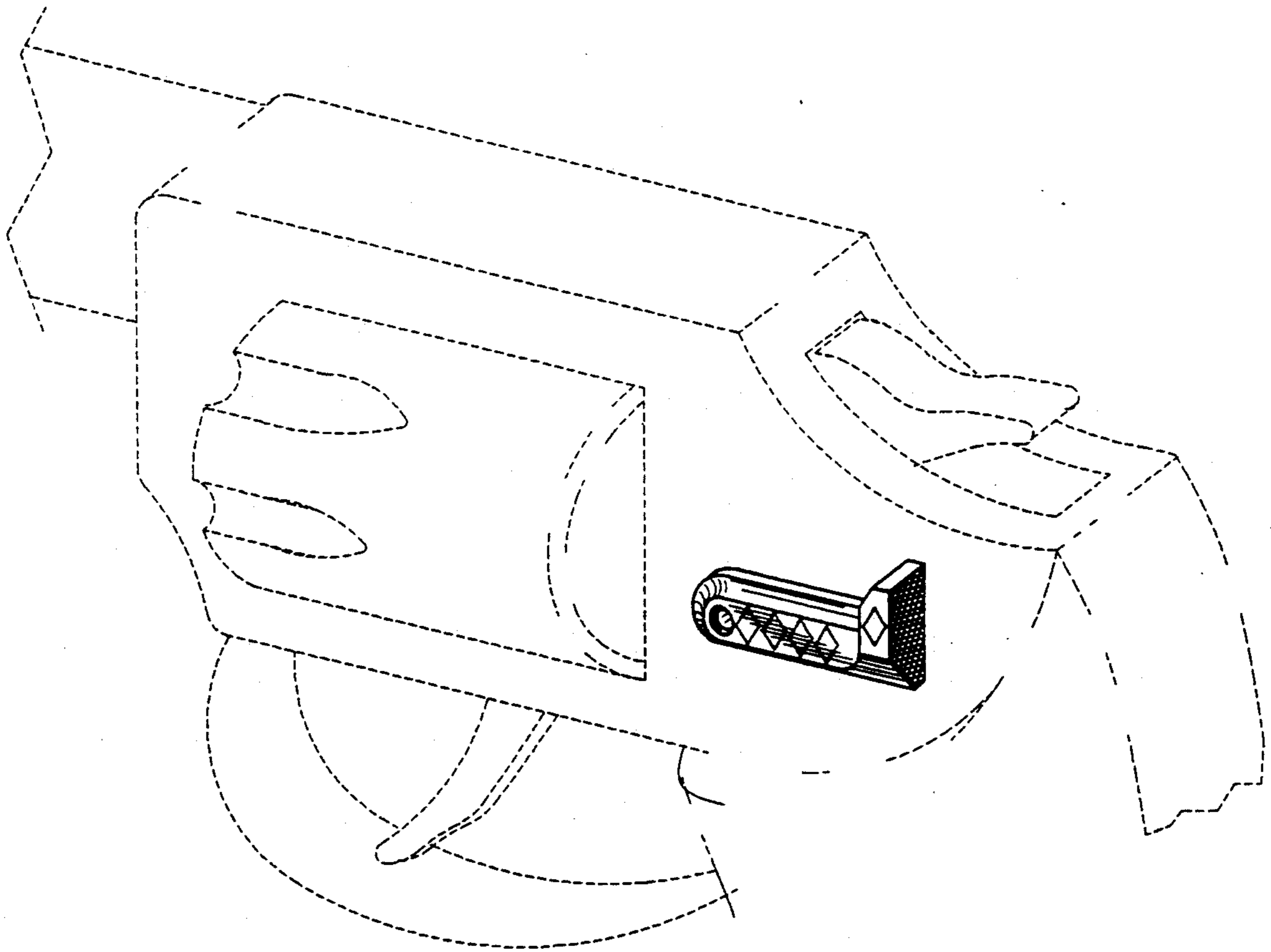

FIG. 1

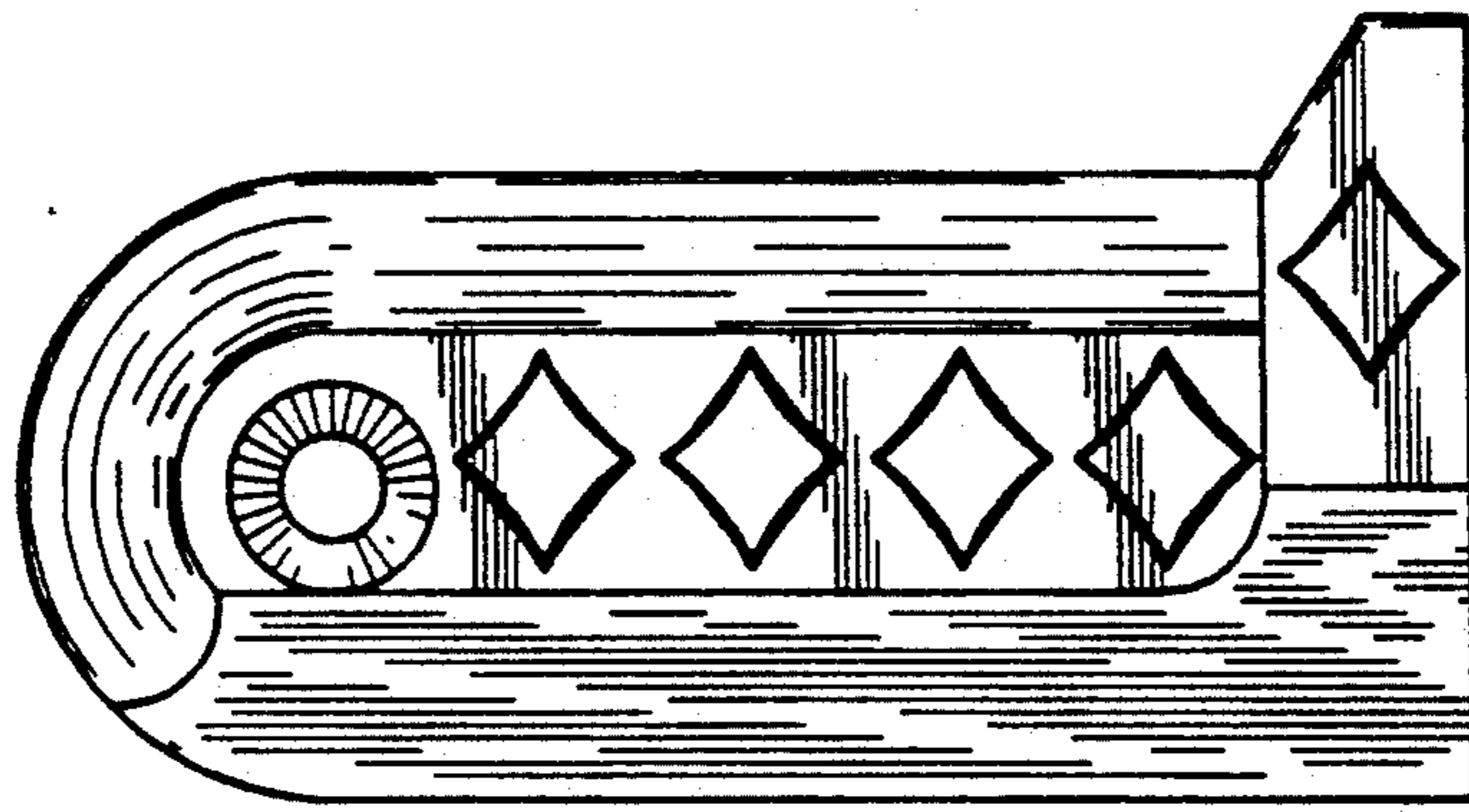

FIG. 2

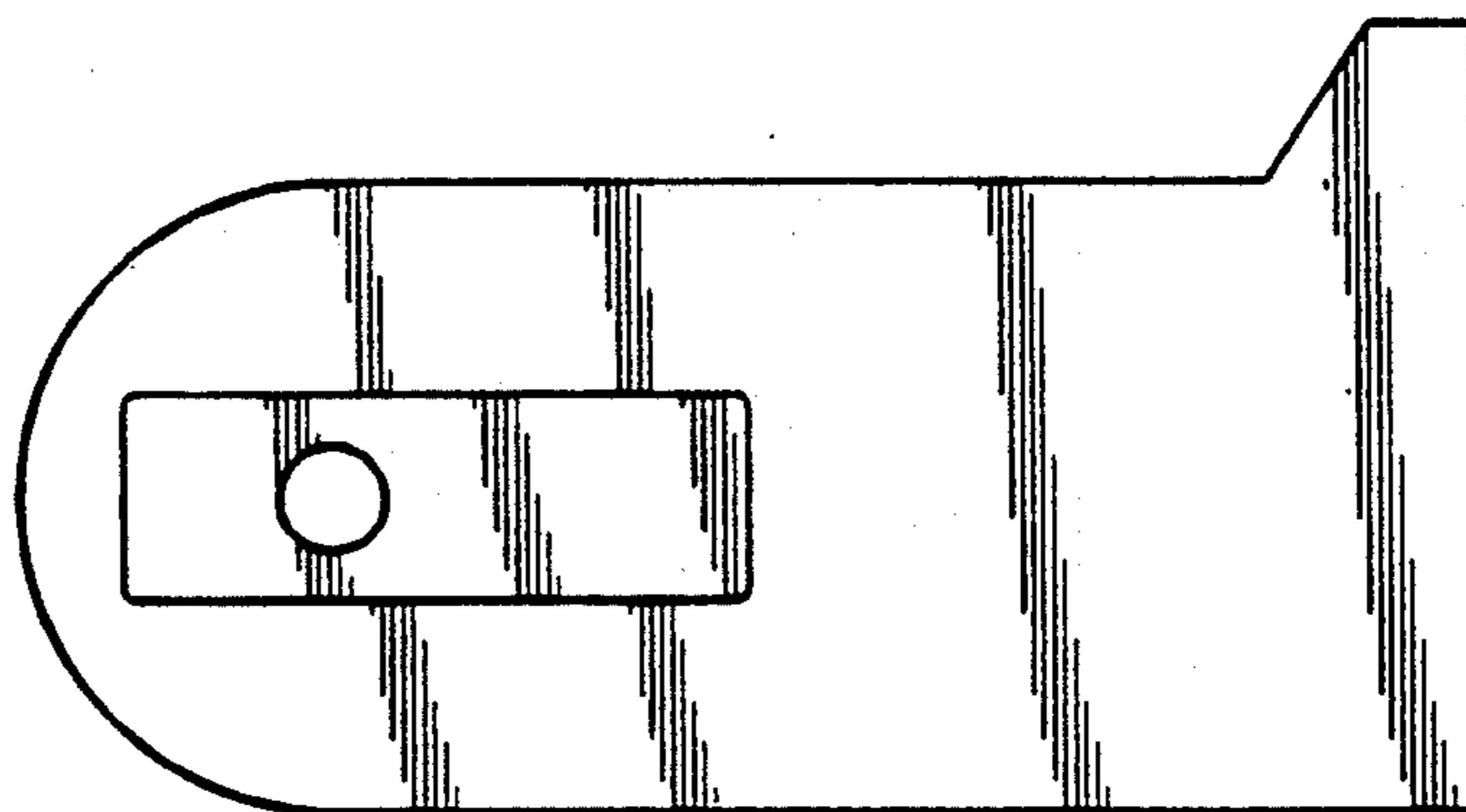

FIG. 3

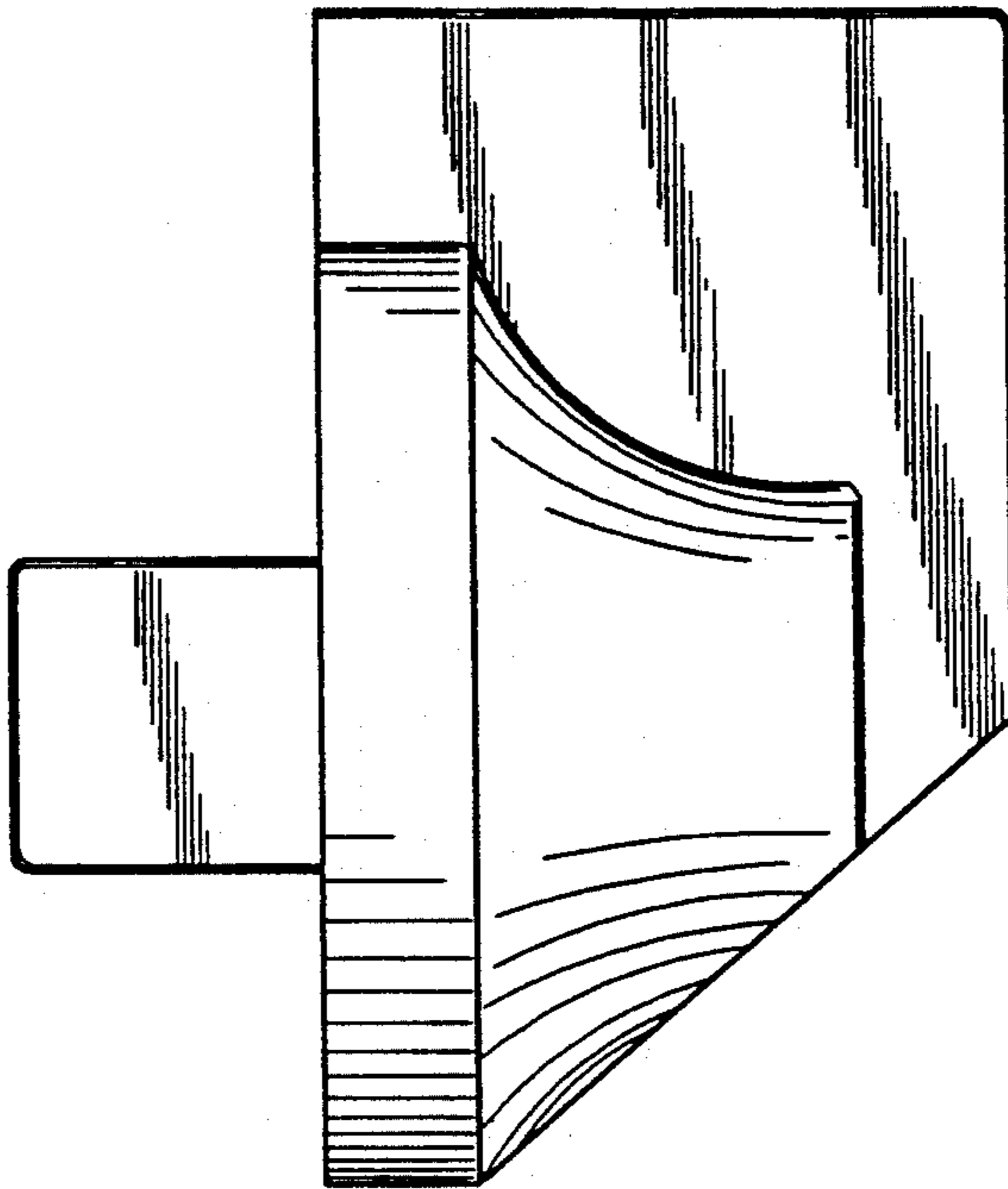

FIG. 4

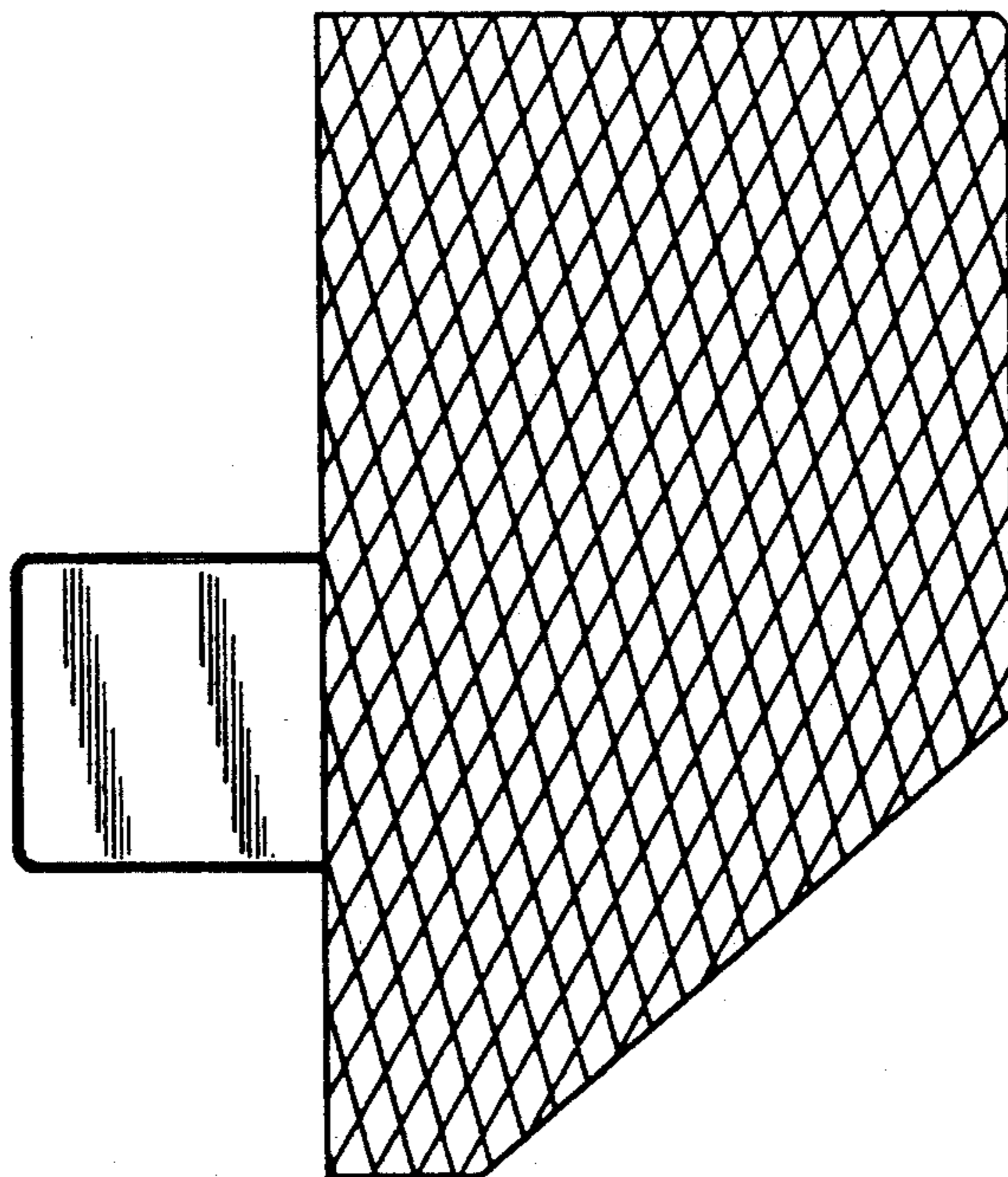

FIG. 5

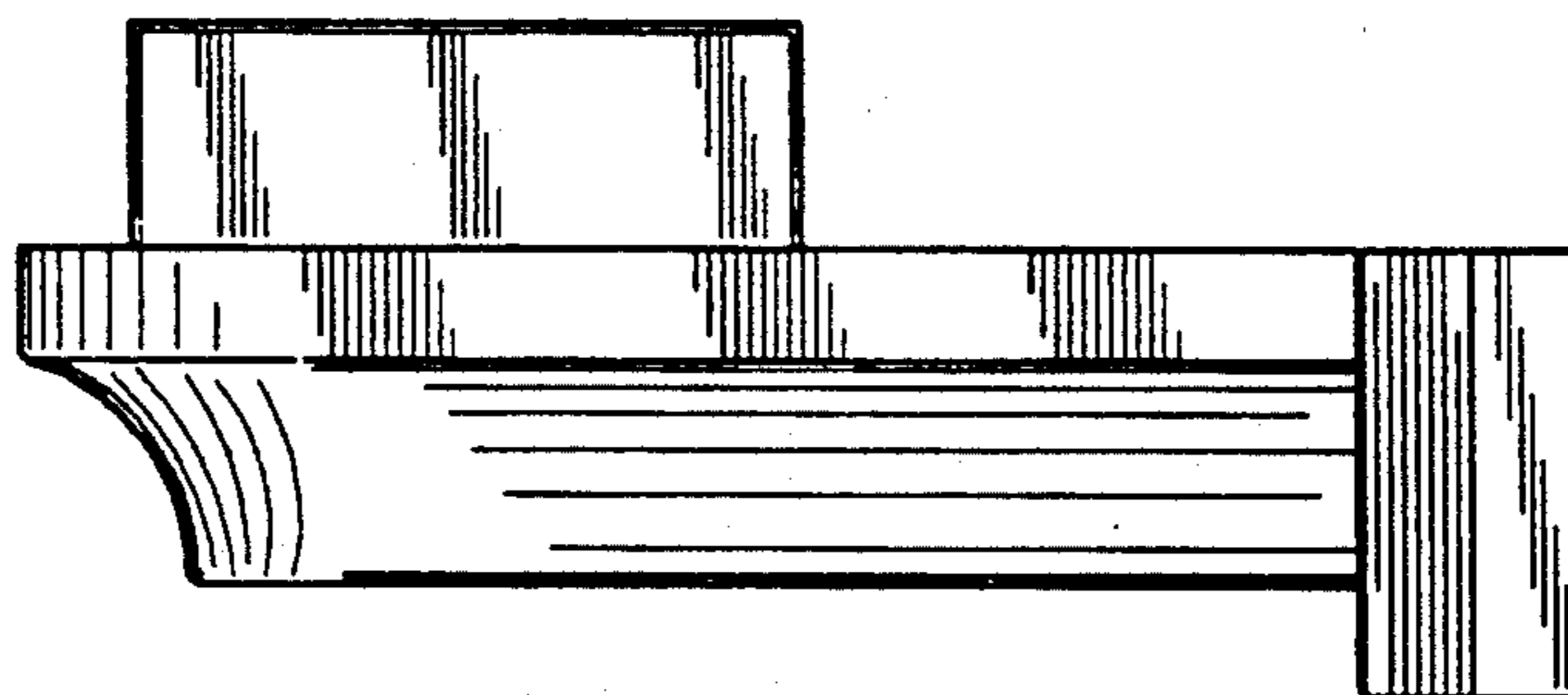

FIG. 6

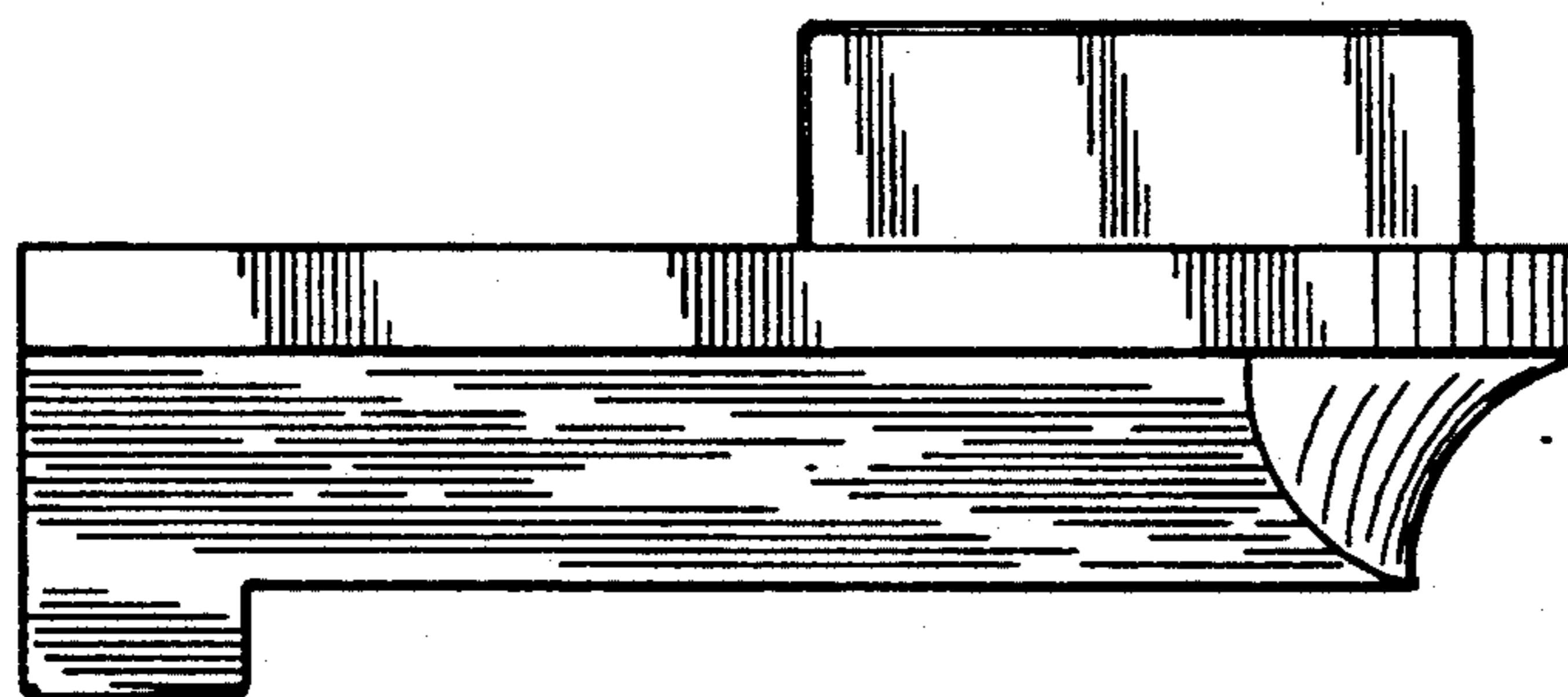

FIG. 7

