



US00D335795S

# United States Patent [19]

[11] Patent Number: Des. 335,795

Conti

[45] Date of Patent: \*\* May 25, 1993

[54] SLOTTED DISH

[75] Inventor: Rino Conti, Stoughton, Mass.

[73] Assignee: Dart Industries, Inc., Deerfield, Ill.

[\*\*] Term: 14 Years

[21] Appl. No.: 561,533

[22] Filed: Aug. 1, 1990

[52] U.S. Cl. .... D7/545; D7/550;  
D7/359

[58] Field of Search ..... D7/392.1, 359, 355,  
D7/362, 397, 363, 391, 550, 552, 557, 538, 570,  
545, 543, 549, 553, 554, 555, 500; 220/574, 575

[56] References Cited

U.S. PATENT DOCUMENTS

D. 223,854	6/1972	Swett .....	D7/392.1
D. 230,381	2/1974	Reiss .....	D7/359 X
D. 230,574	3/1974	Comisso .....	D7/392.1 X
D. 251,654	4/1979	Mason, Jr. et al. ....	D7/543 X
D. 257,463	10/1980	Campbell et al. .	
D. 264,036	4/1982	Pomroy et al. ....	D7/359
D. 269,586	7/1983	Allgeyer et al. ....	D7/543 X
D. 269,586	7/1983	Allgeyer et al. ....	D7/543 X
D. 269,593	7/1983	Gruodis et al. .	
D. 281,480	11/1985	McClelland .	
D. 287,208	12/1986	Daenen et al. .	
D. 288,649	3/1987	Daenen et al. .	

D. 298,199	10/1988	Finsilver et al. ....	D7/545 X
D. 312,941	10/1970	Zivin .....	D7/545
D. 325,684	4/1992	Deare .....	D7/500 X
229,467	6/1880	Remhof .....	D7/552 X
506,120	10/1893	Kiel .....	D7/552 X
1,413,063	4/1922	Sailer .....	D7/545 X
2,822,952	2/1958	Scott .	
5,065,889	11/1991	Conti .	

Primary Examiner—Alan P. Douglas  
Assistant Examiner—M. N. Pandozzi  
Attorney, Agent, or Firm—John A. Doninger

[57] CLAIM

The ornamental design for a slotted dish, as shown and described.

DESCRIPTION

FIG. 1 is a top perspective view of a slotted dish showing my new design;  
FIG. 2 is a top plan view thereof;  
FIG. 3 is a bottom plan view thereof;  
FIG. 4 is a left side elevational view, the right side elevational view being a mirror image thereof;  
FIG. 5 is a front elevational view, the rear elevational view being a mirror image thereof;  
FIG. 6 is a cross-sectional view thereof taken along line 6—6 of FIG. 2; and,  
FIG. 7 is a cross-sectional view thereof taken along line 7—7 of FIG. 2.

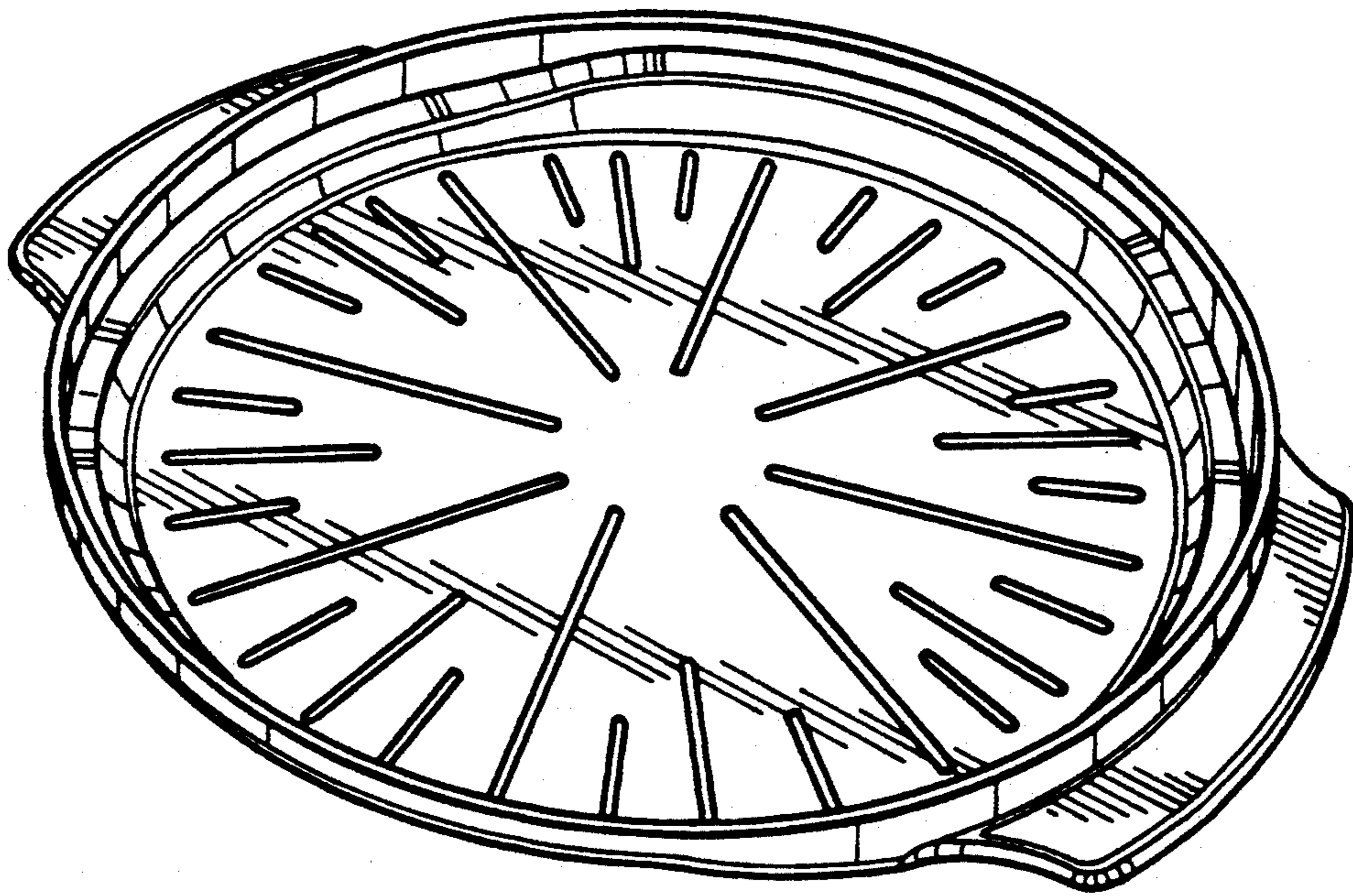

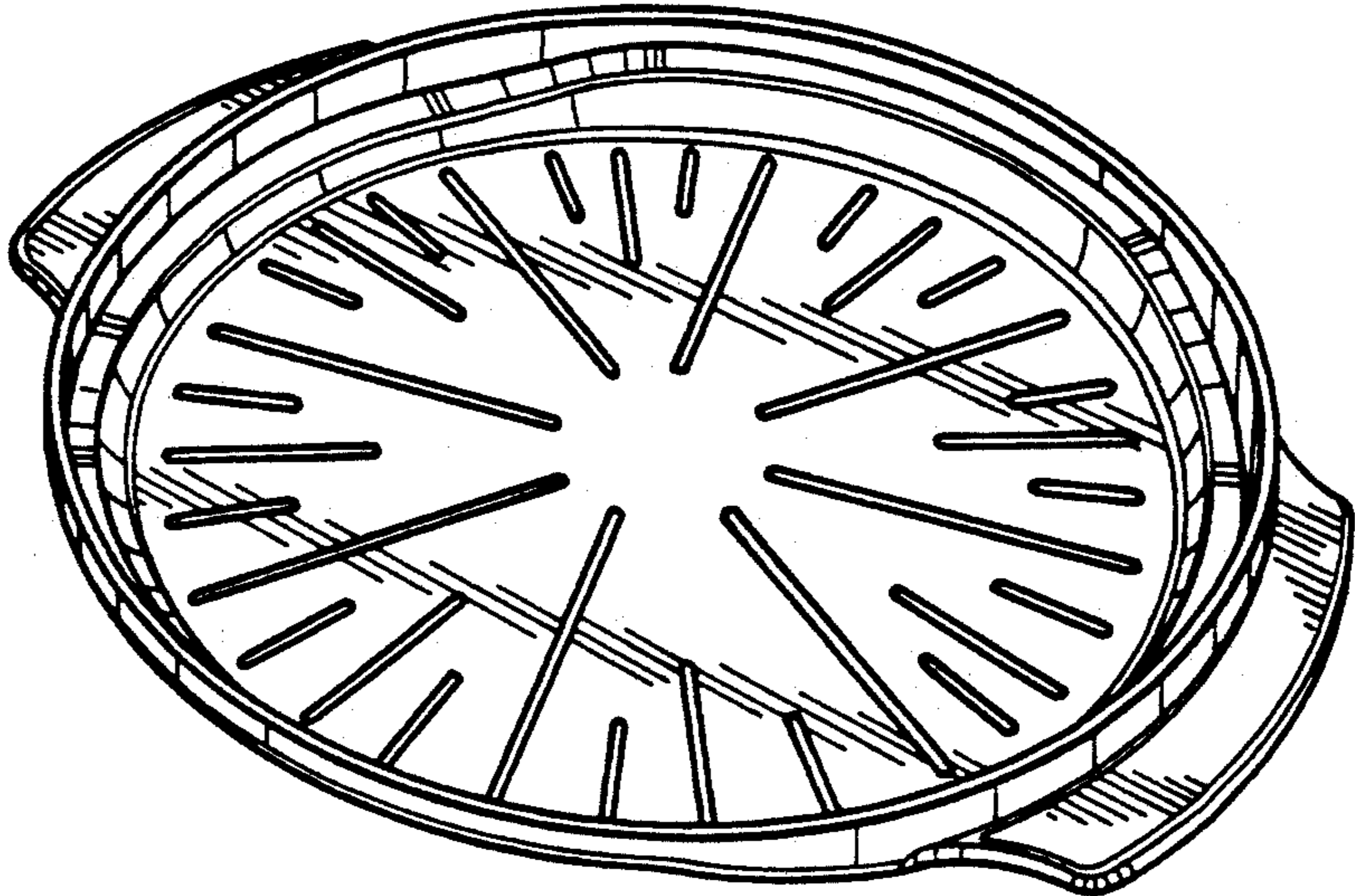

FIG. 1

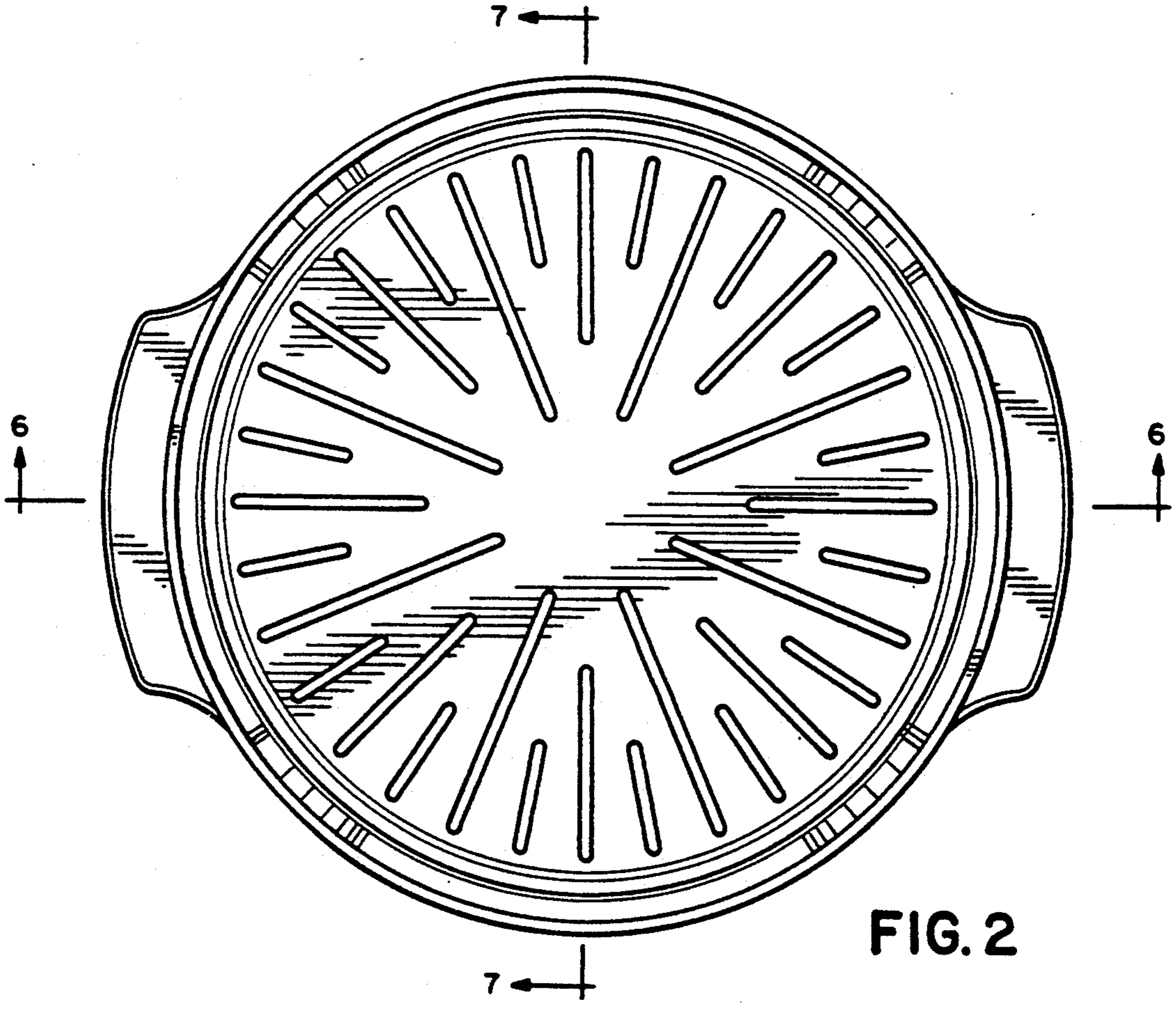

FIG. 2

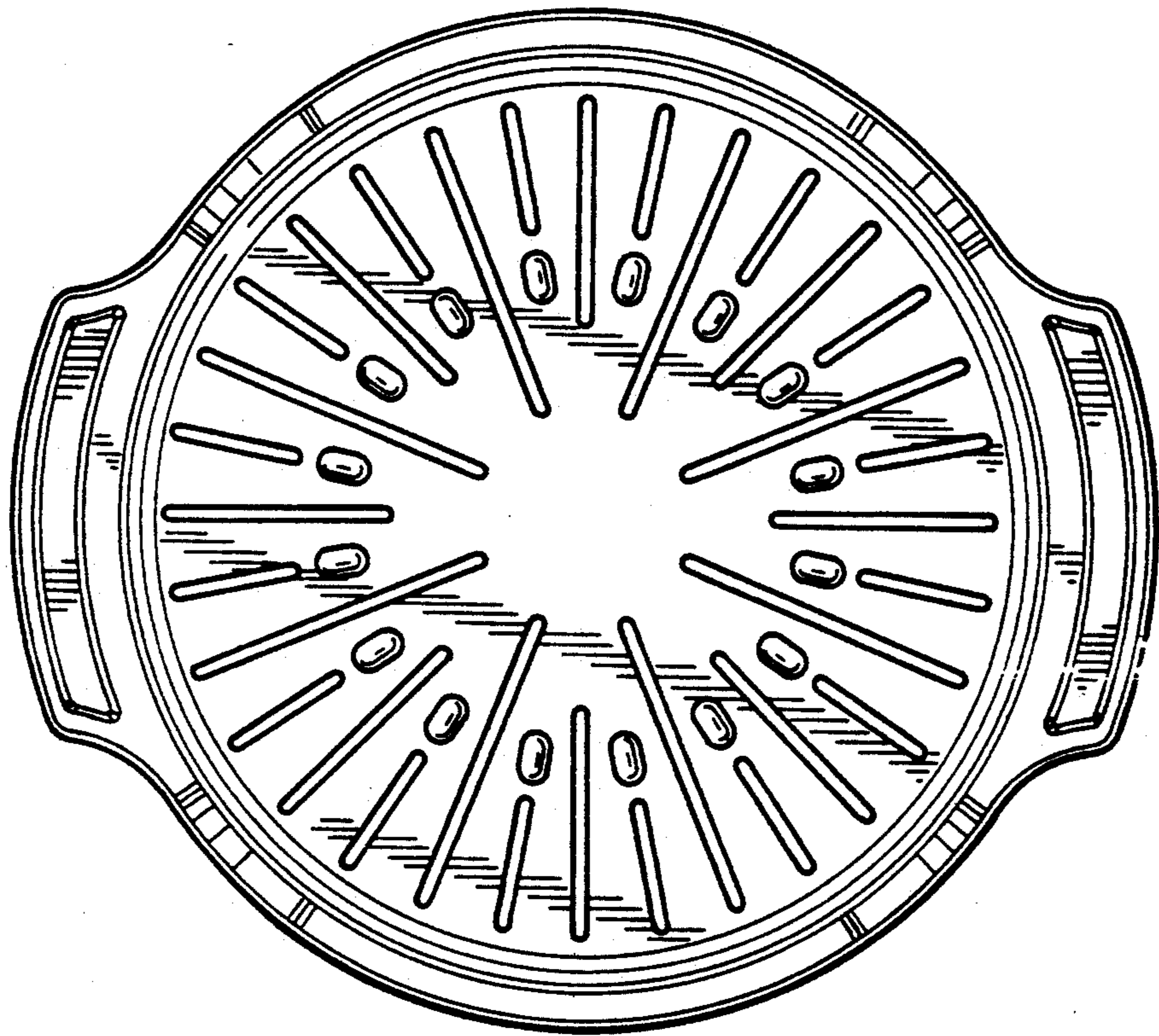

FIG. 3

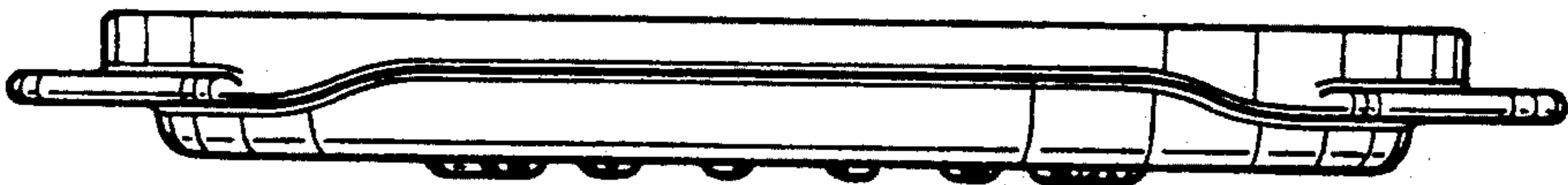

FIG. 4

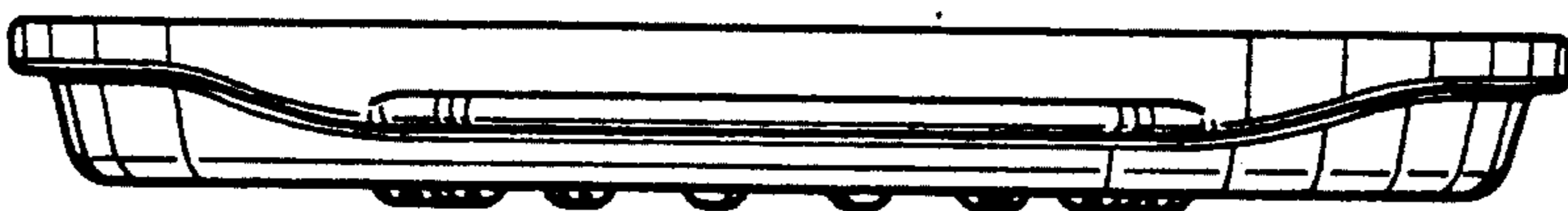

FIG. 5

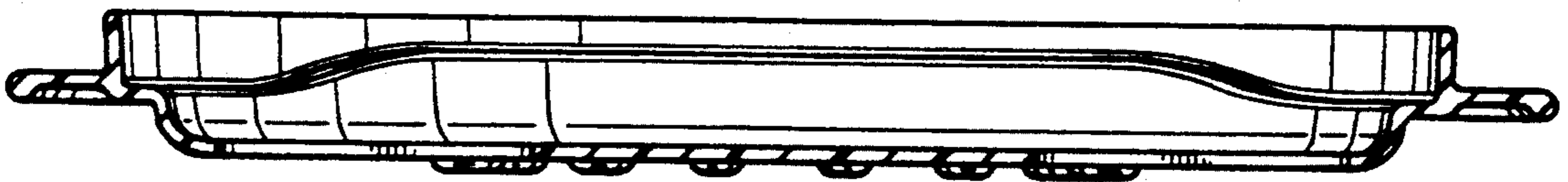

FIG. 6



FIG. 7