



US00D335775S

United States Patent [19]

[11] Patent Number: Des. 335,775

Lamalle

[45] Date of Patent: ** May 25, 1993

[54] CHAISE LOUNGE

D. 326,584 6/1992 van de Ven D6/361
D. 329,557 9/1992 Hubert D6/502

[75] Inventor: Christian Lamalle, Saint Ismier, France

OTHER PUBLICATIONS

[73] Assignee: Allibert, S.A., Grenoble, France

Brown Jordan, ©1986, p. 50, Lounge #1720-7100 at top left.

[**] Term: 14 Years

Primary Examiner—Alan P. Douglas
Assistant Examiner—Gary D. Watson
Attorney, Agent, or Firm—Foley & Lardner

[21] Appl. No.: 626,859

[22] Filed: Dec. 13, 1990

[57] CLAIM

[30] Foreign Application Priority Data

The ornamental design for a chaise lounge, as shown and described.

Jun. 14, 1990 [WO] World Int. Prop. O. DM/016919

[52] U.S. Cl. D6/361; D6/369

[58] Field of Search D6/334, 360, 361, 367, D6/368, 369, 370, 374, 375, 376, 379, 500, 501, 502; 297/16, 17, 31, 418, 419

DESCRIPTION

[56] References Cited

U.S. PATENT DOCUMENTS

D. 294,890 3/1988 Hubert D6/361
D. 296,849 7/1988 Cronk D6/361

FIG. 1 is a front perspective view of a chaise lounge showing my new design;
FIG. 2 is a front view thereof;
FIG. 3 is a top view thereof;
FIG. 4 is a bottom view thereof;
FIG. 5 is a side view thereof; and,
FIG. 6 is a rear view thereof.

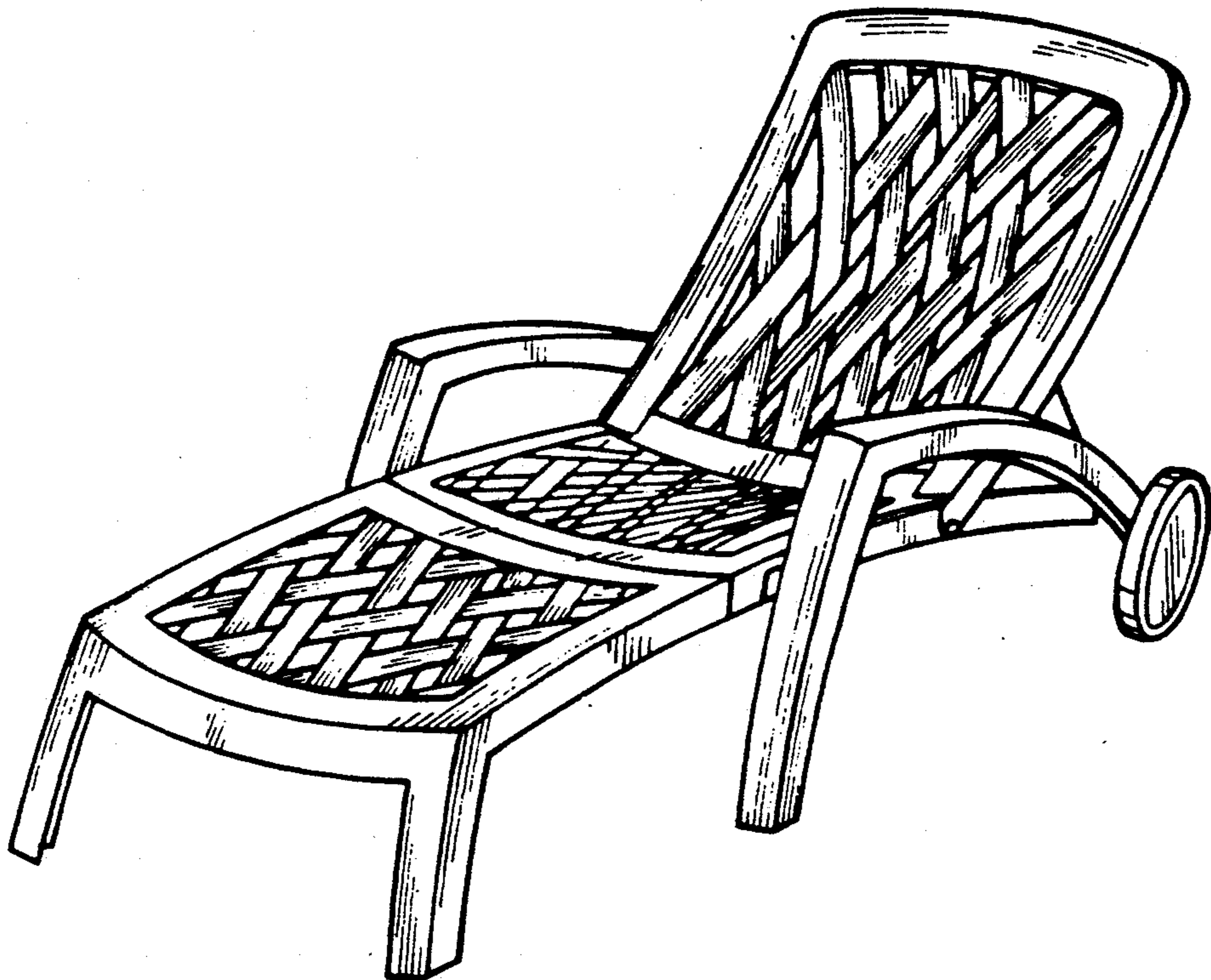

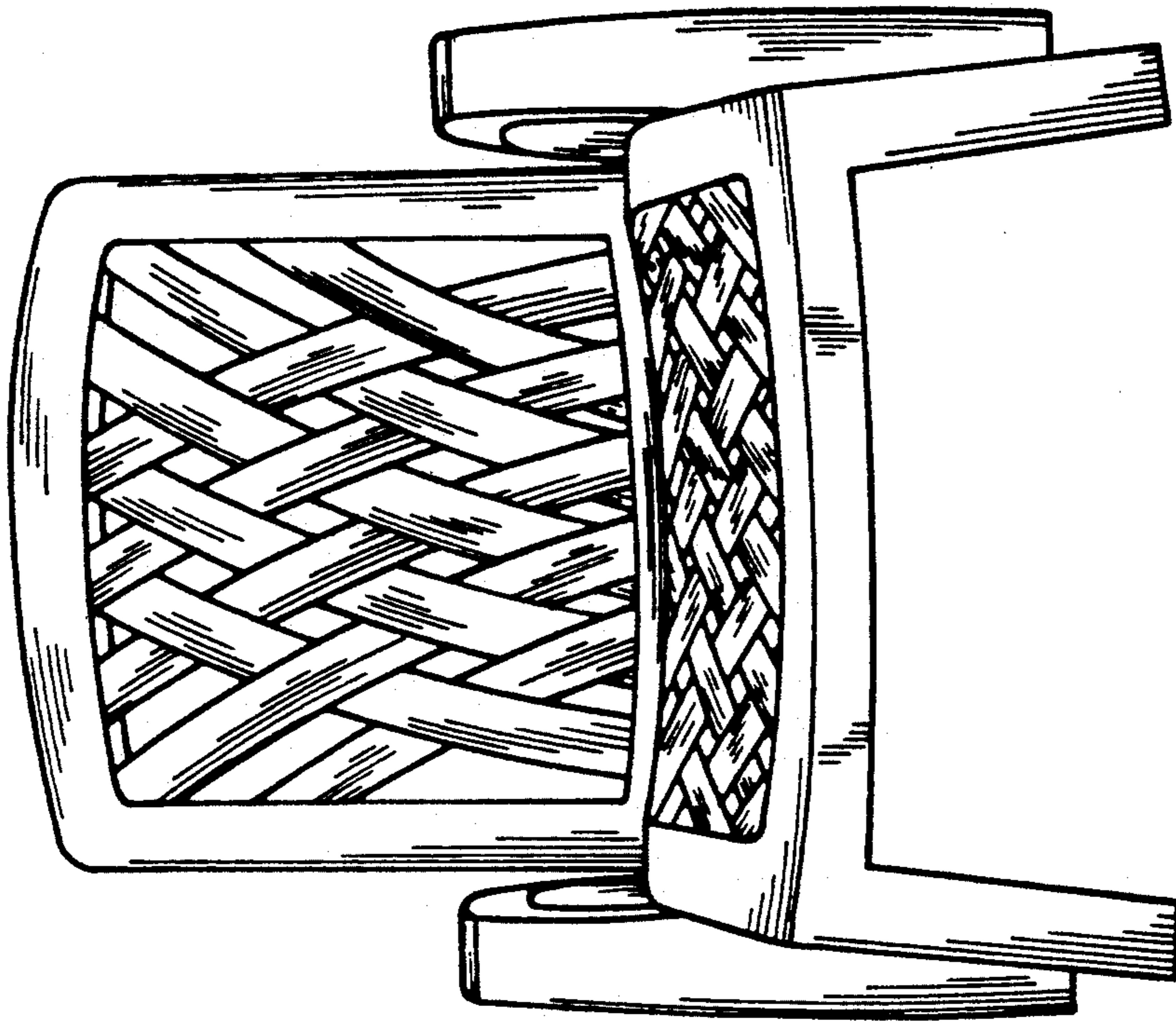

FIG. 2

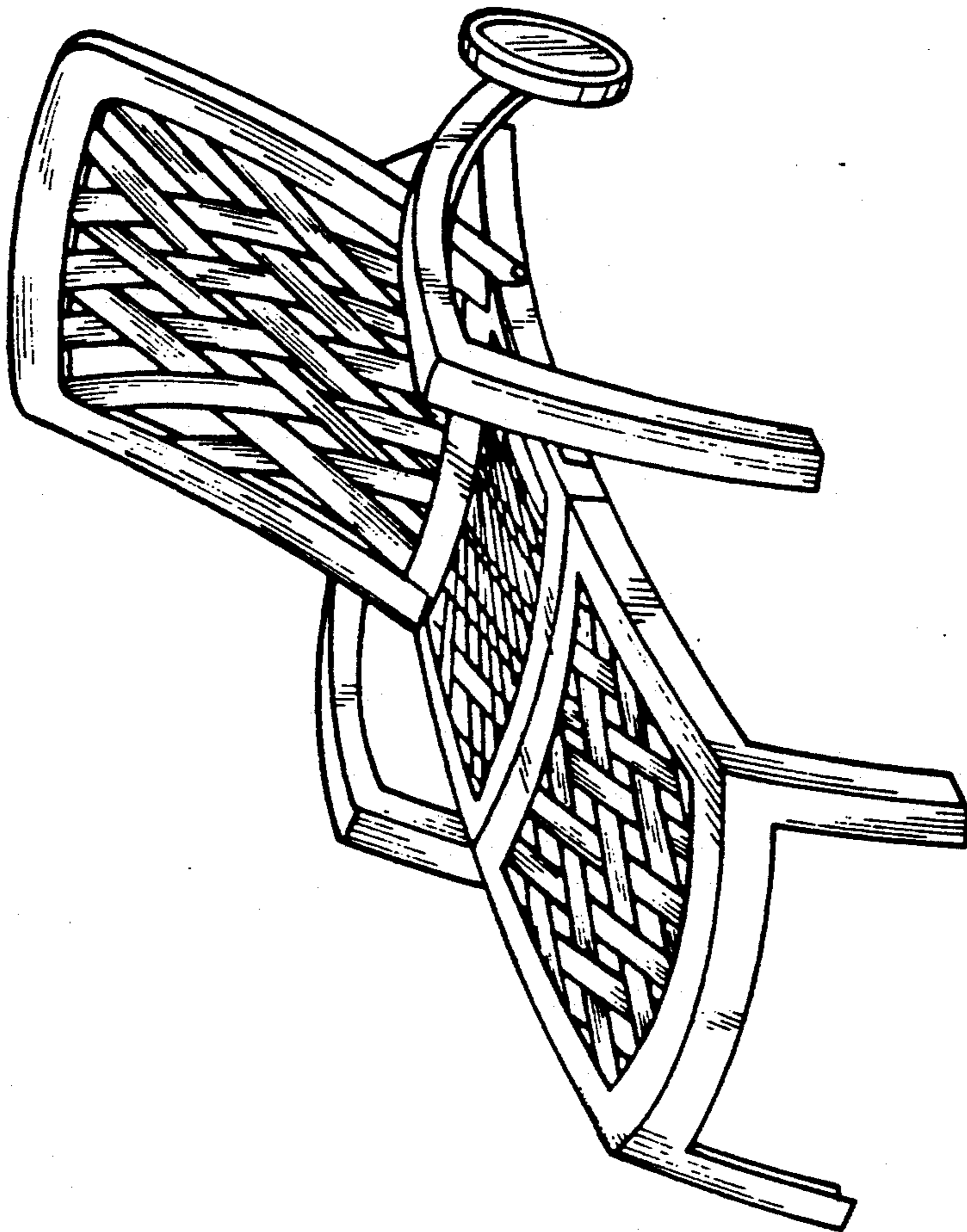

FIG. 1

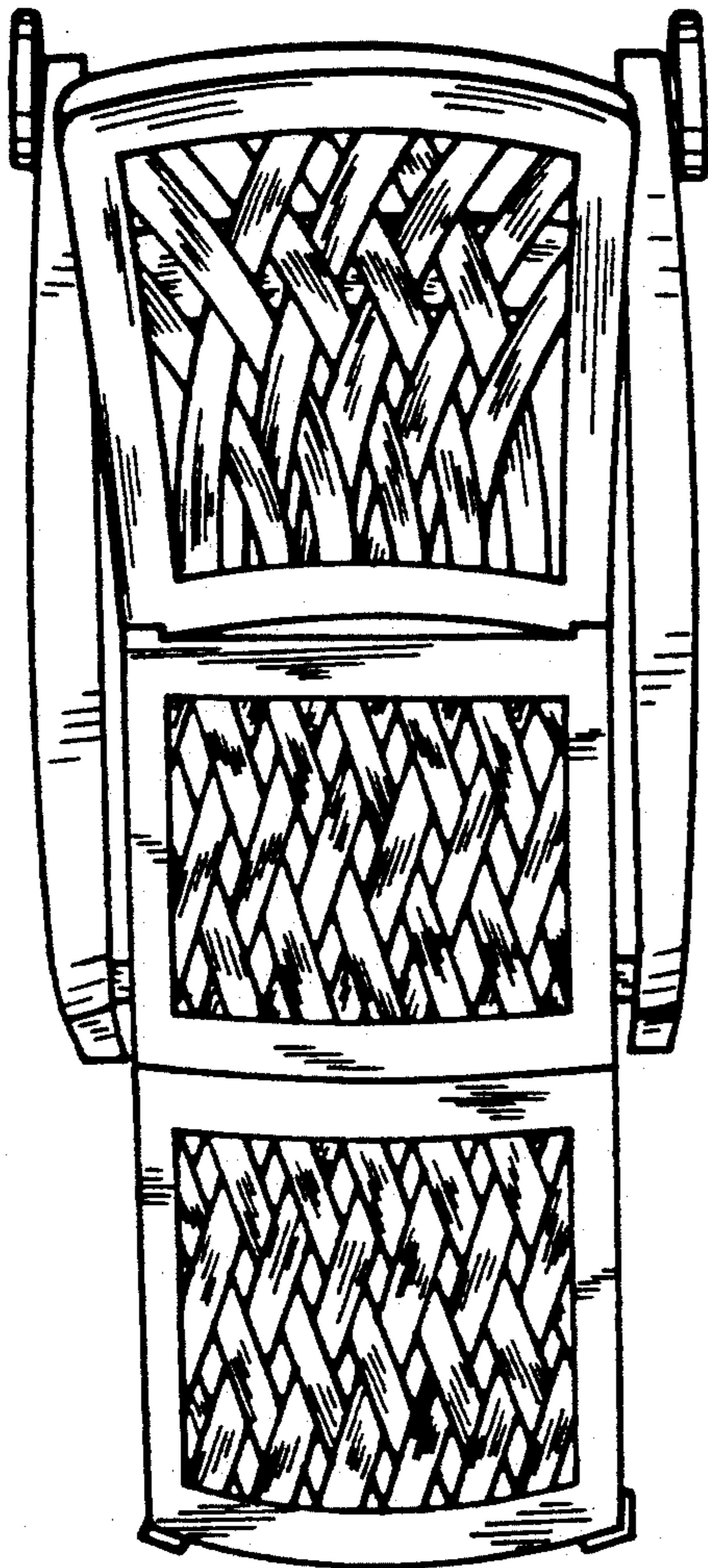

FIG. 3

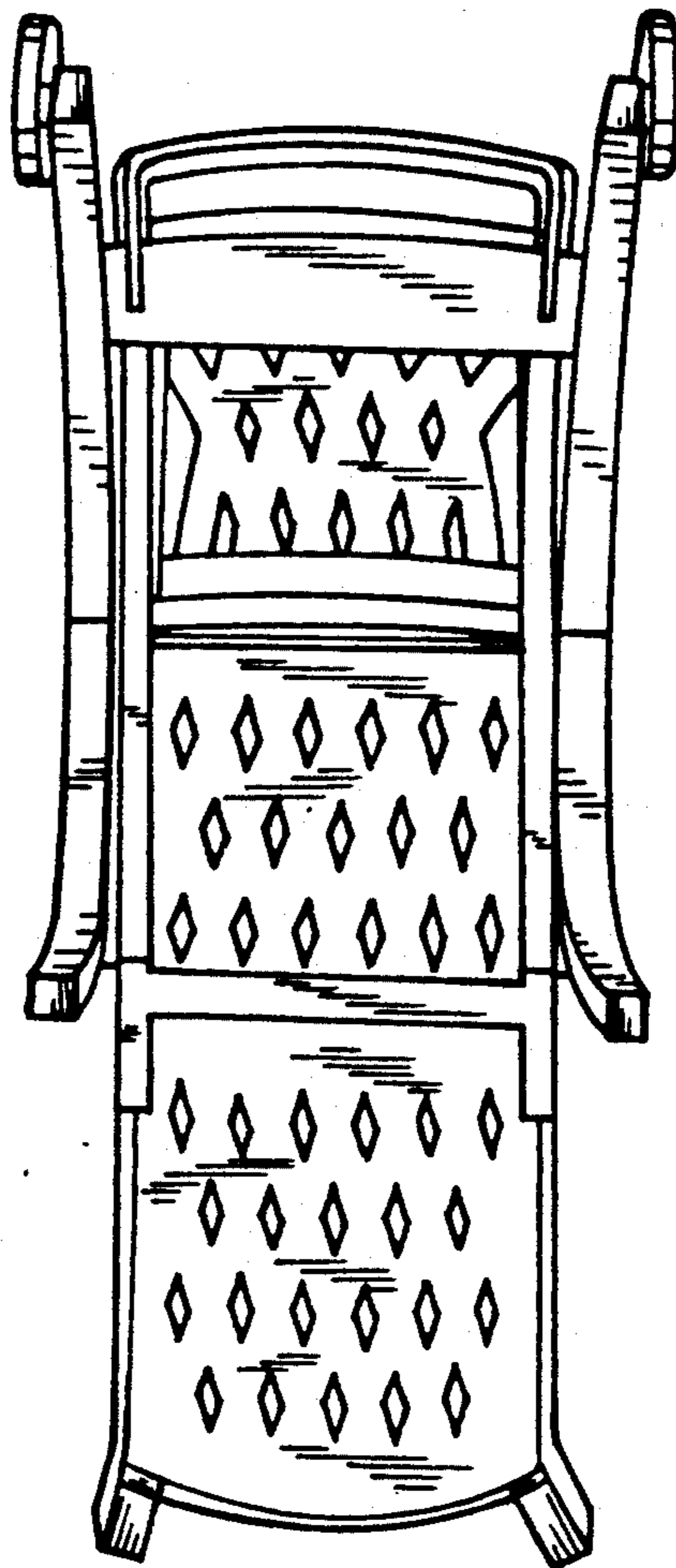

FIG. 4

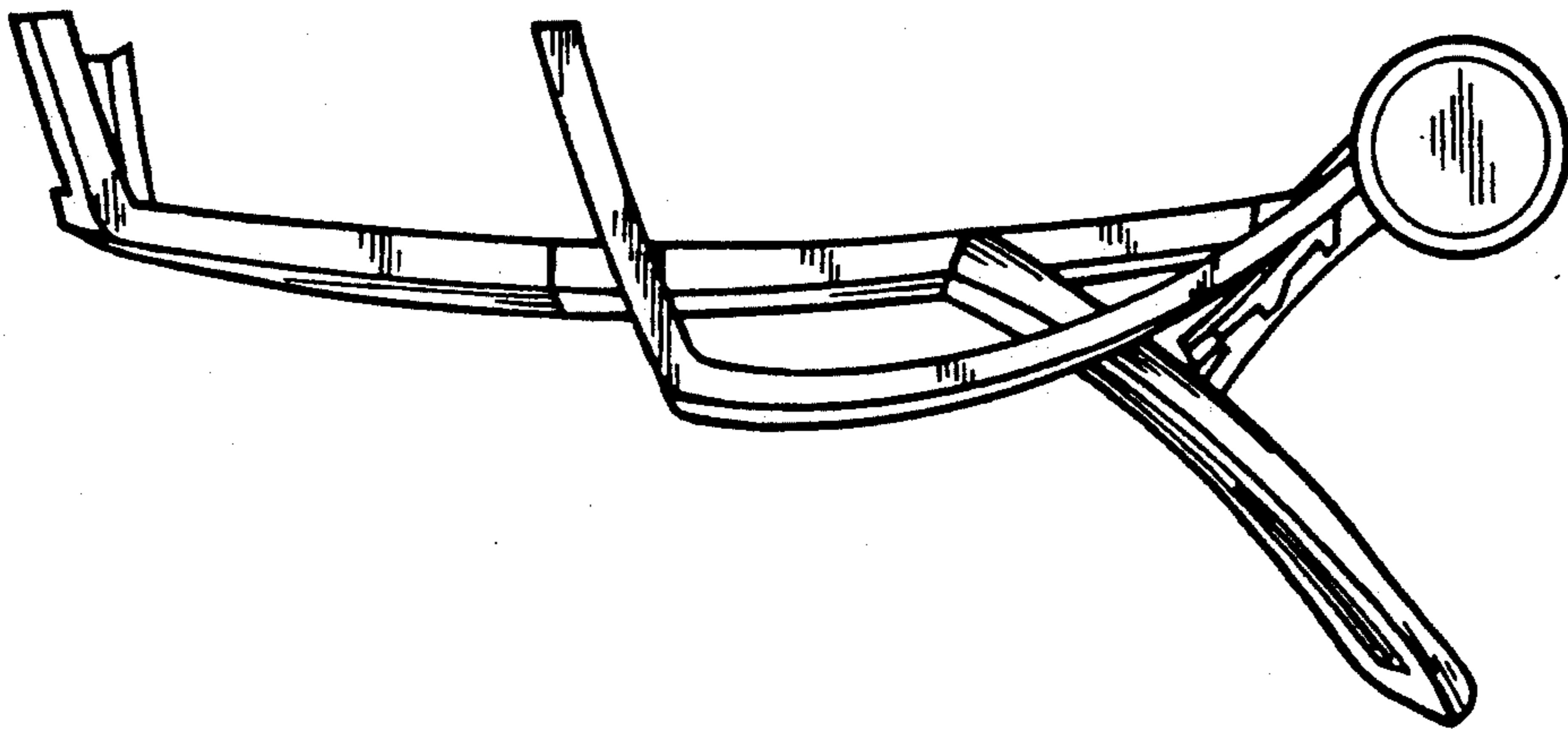

FIG. 5

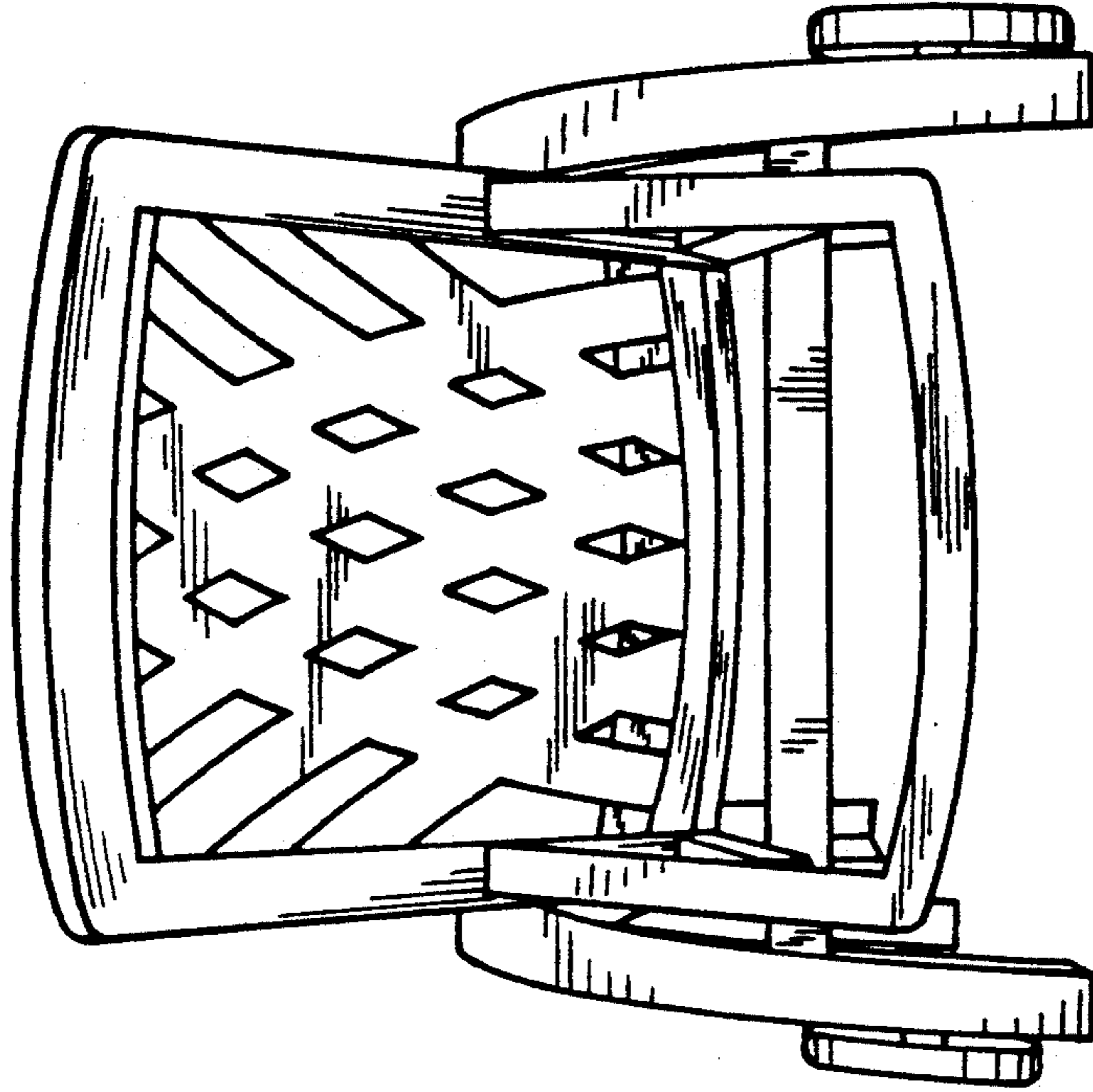

FIG. 6