



US00D335755S

United States Patent [19]

[11] Patent Number: **Des. 335,755**

Davis et al.

[45] Date of Patent: **** May 18, 1993**

[54] RUBBER MAILBOX

OTHER PUBLICATIONS

[76] Inventors: **Cole Davis; Jason Adams**, both of 19 Piney Trail, Cabot, Ark. 72023

Chartpak Cat., dated 1984, p. 24, Border Tape No. TL816A.

[**] Term: **14 Years**

Primary Examiner—Alan P. Douglas
Assistant Examiner—J. H. Musgrove
Attorney, Agent, or Firm—Terry M. Gernstein

[21] Appl. No.: **518,853**

[57] CLAIM

[22] Filed: **May 4, 1990**

We claim the ornamental design for a rubber mailbox, as shown and described.

[52] U.S. Cl. **D99/32**

[58] Field of Search **D99/30, 31, 32; 232/34, 232/17**

DESCRIPTION

[56] References Cited

U.S. PATENT DOCUMENTS

D. 309,757 8/1990 Fabbri D20/42
4,244,512 1/1981 Wise D99/32 X

FIG. 1 is an enlarged top, front and left-side perspective view of a rubber mailbox showing our new design; FIG. 2 is a front elevational view; FIG. 3 is a rear elevational view; FIG. 4 is a left side elevational view; FIG. 5 is a right side elevational view; and, FIG. 6 is a top plan view thereof.

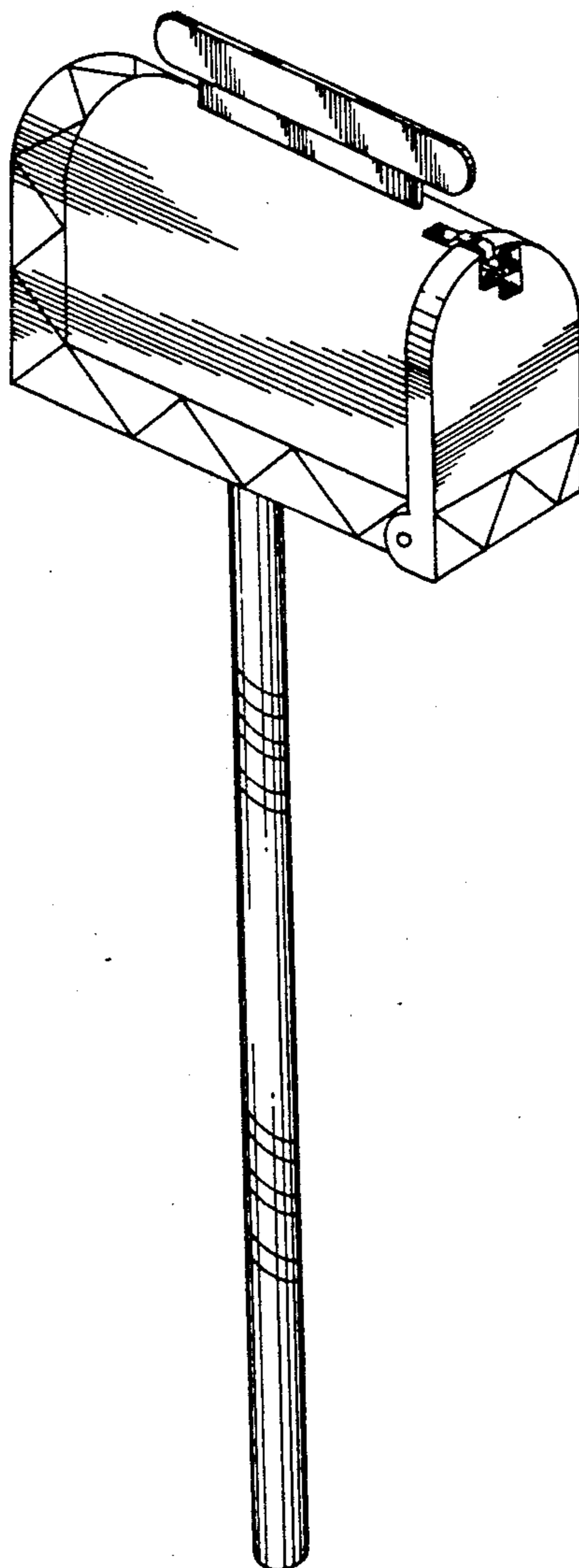

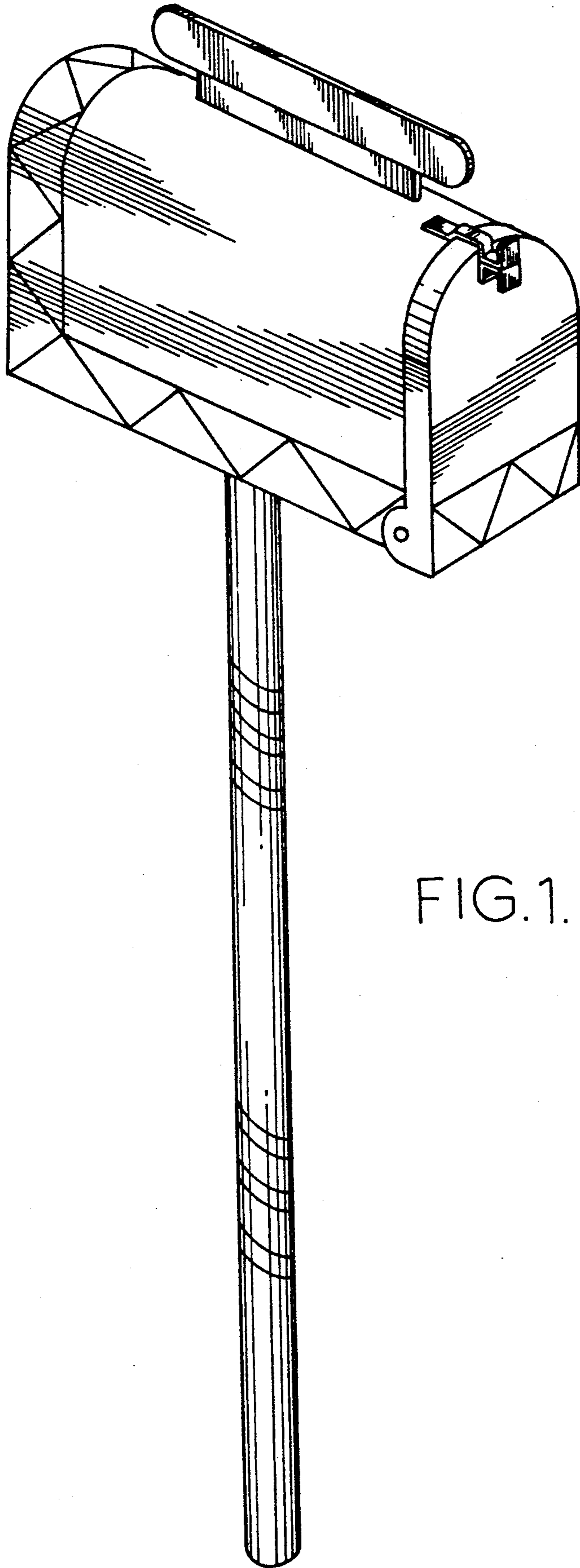

FIG. 1.

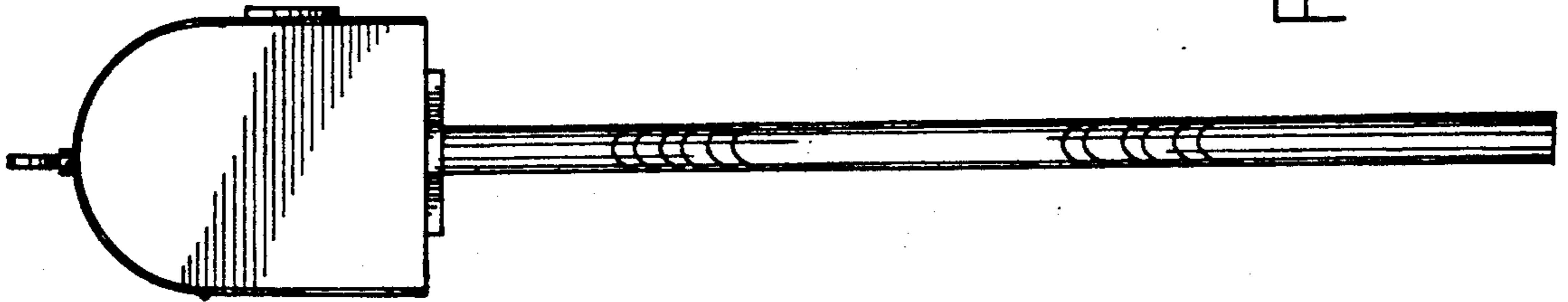

FIG. 2.

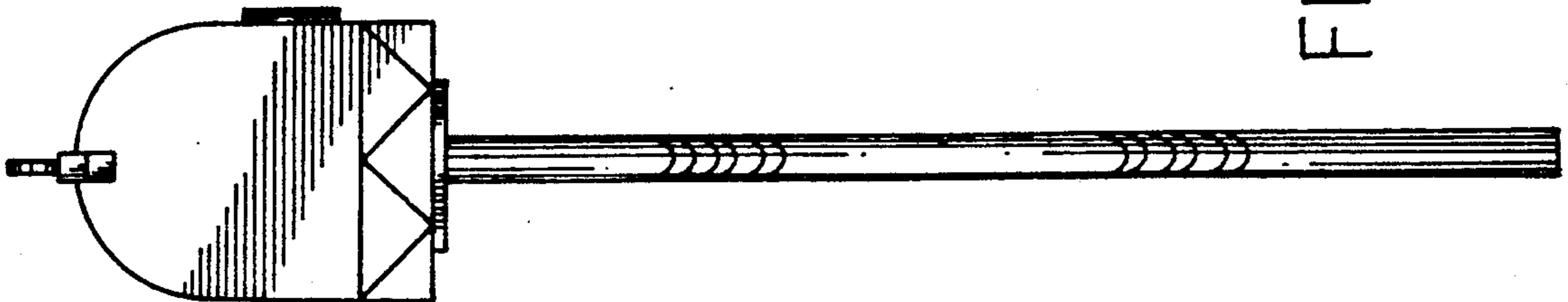

FIG. 3.

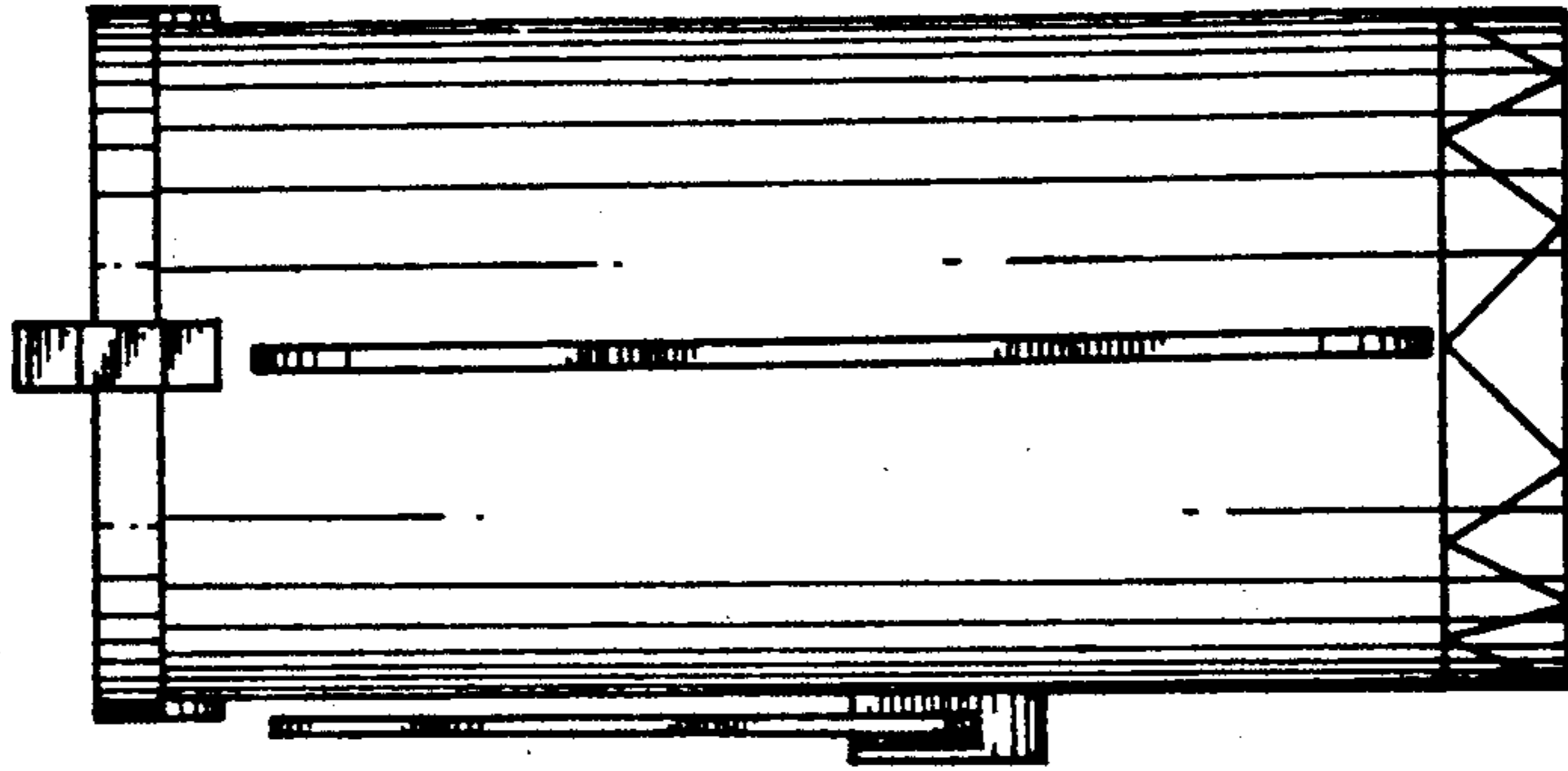

FIG. 6.

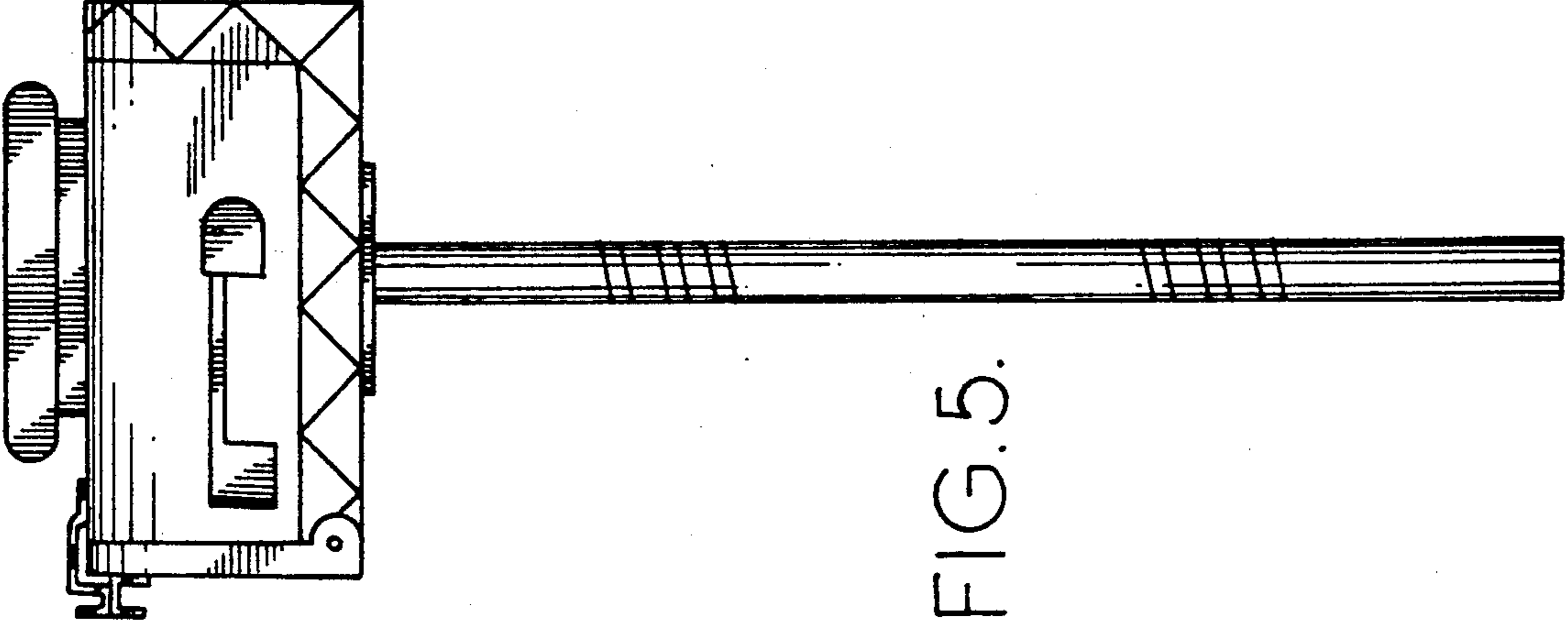

FIG. 5.

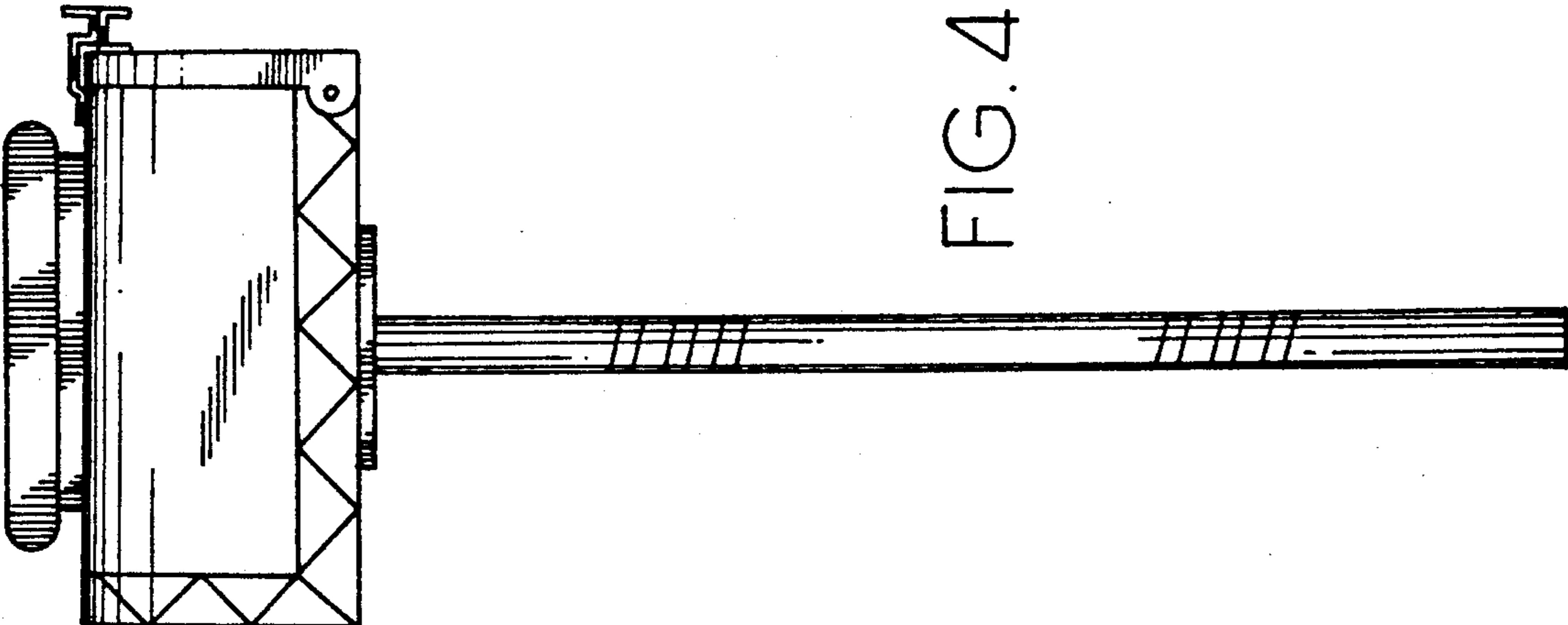

FIG. 4.