



US00D335719S

# United States Patent [19]

[11] Patent Number: **Des. 335,719**

**Kuo**

[45] Date of Patent: **\*\* May 18, 1993**

[54] **ARM FOR ADJUSTABLE LAMP SUPPORT**

*Primary Examiner*—Susan J. Lucas

[76] Inventor: **J. T. Kuo**, 1F., No. 92, Chao Yang Street, Kon Liao Hsiang, Taipei Hsien, Taiwan

*Attorney, Agent, or Firm*—Pro-Tehtor International

[\*\*] Term: **14 Years**

[57] **CLAIM**

[21] Appl. No.: **774,272**

The ornamental design for arm for adjustable lamp support, as shown and described.

[22] Filed: **Oct. 10, 1991**

**DESCRIPTION**

[52] U.S. Cl. .... **D26/140; D26/65**

**FIG. 1** is a perspective view of a arm for adjustable lamp support showing my new design;

[58] Field of Search ..... **D26/61-66,**

**FIG. 2** is a front elevational view thereof;

**D26/138, 140; 362/269, 275, 414, 413, 418, 419, 427; 248/280.1, 281.1, 292.1**

**FIG. 3** is a rear elevational view thereof;

**FIG. 4** is a left side elevational view thereof;

**FIG. 5** is a right side elevational view thereof;

**FIG. 6** is a top plan view thereof;

**FIG. 7** is a bottom plan view thereof; and,

**FIG. 8** is a perspective view of the arm on a reduced scale, the lamp and support being shown in broken lines for illustrative purposes only.

[56] **References Cited**

**U.S. PATENT DOCUMENTS**

- D. 327,133 6/1992 Copeland ..... D26/65
- D. 327,544 6/1992 Orozco ..... D26/65

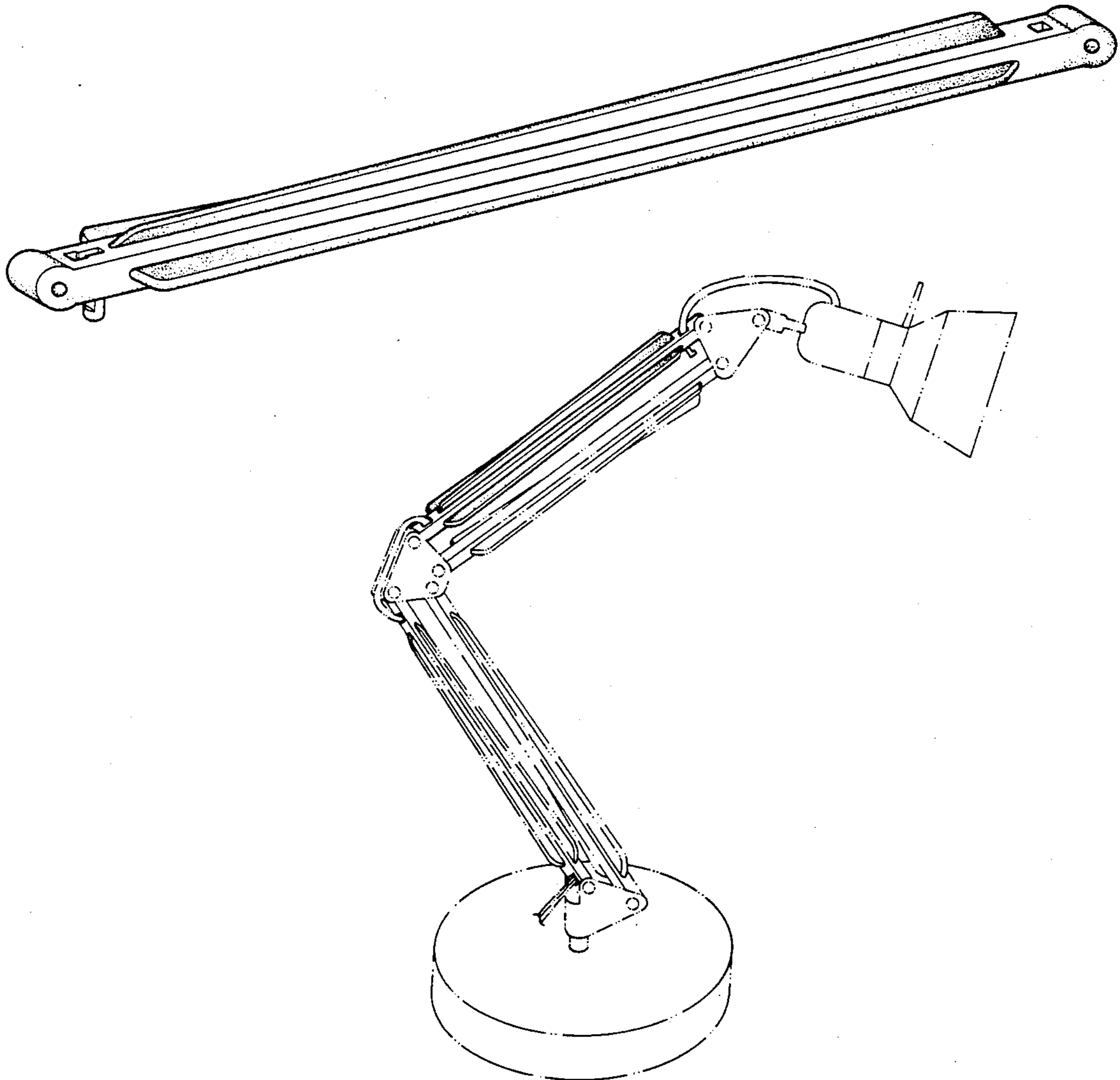

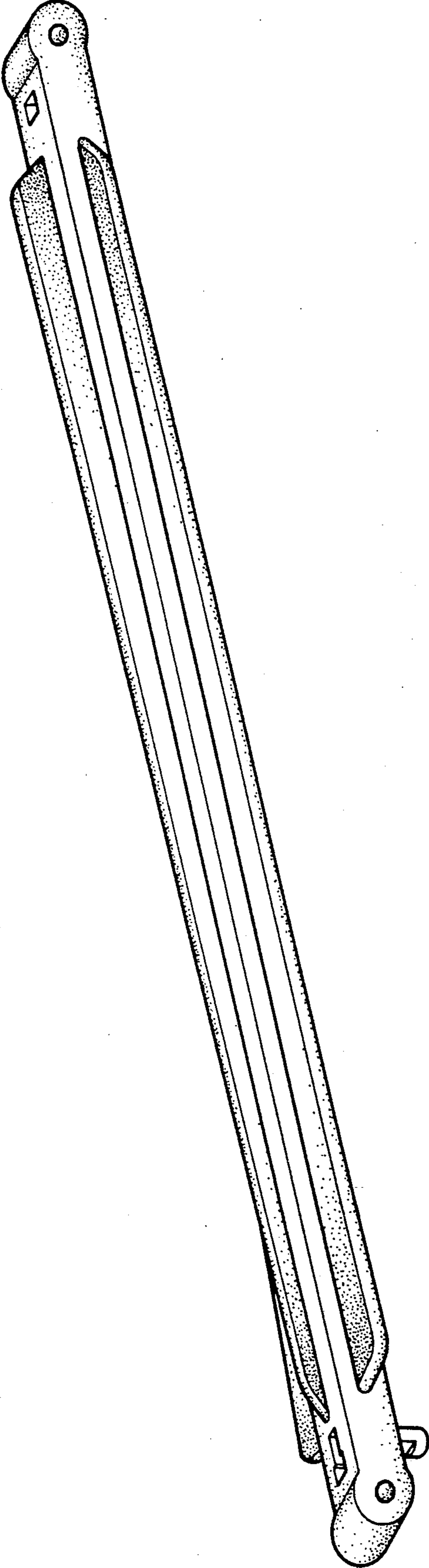

FIG. 1

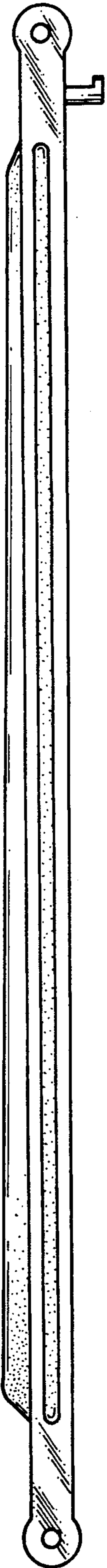

FIG. 2

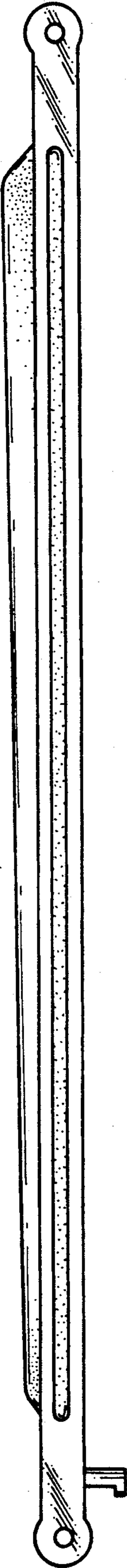

FIG. 3

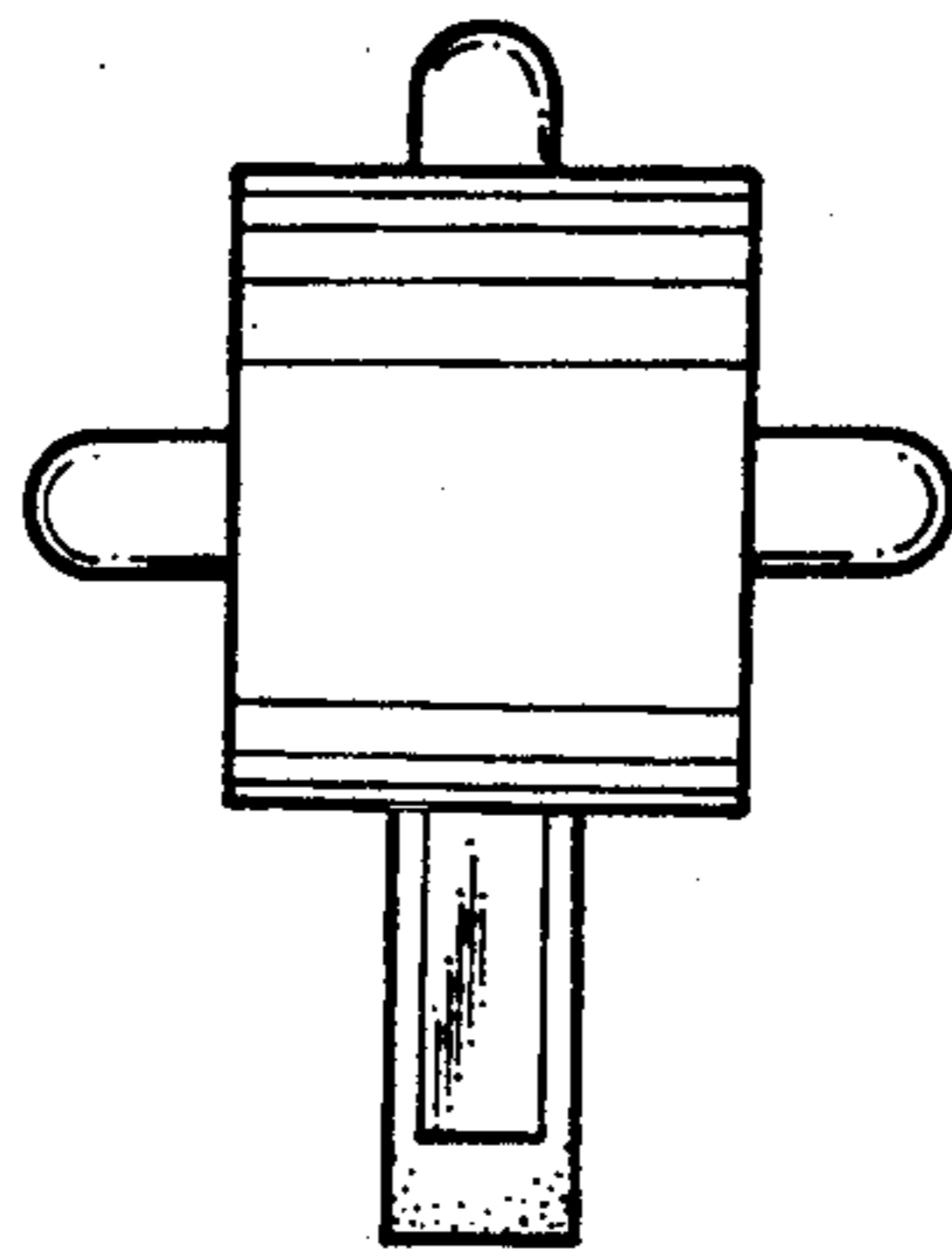

FIG. 4

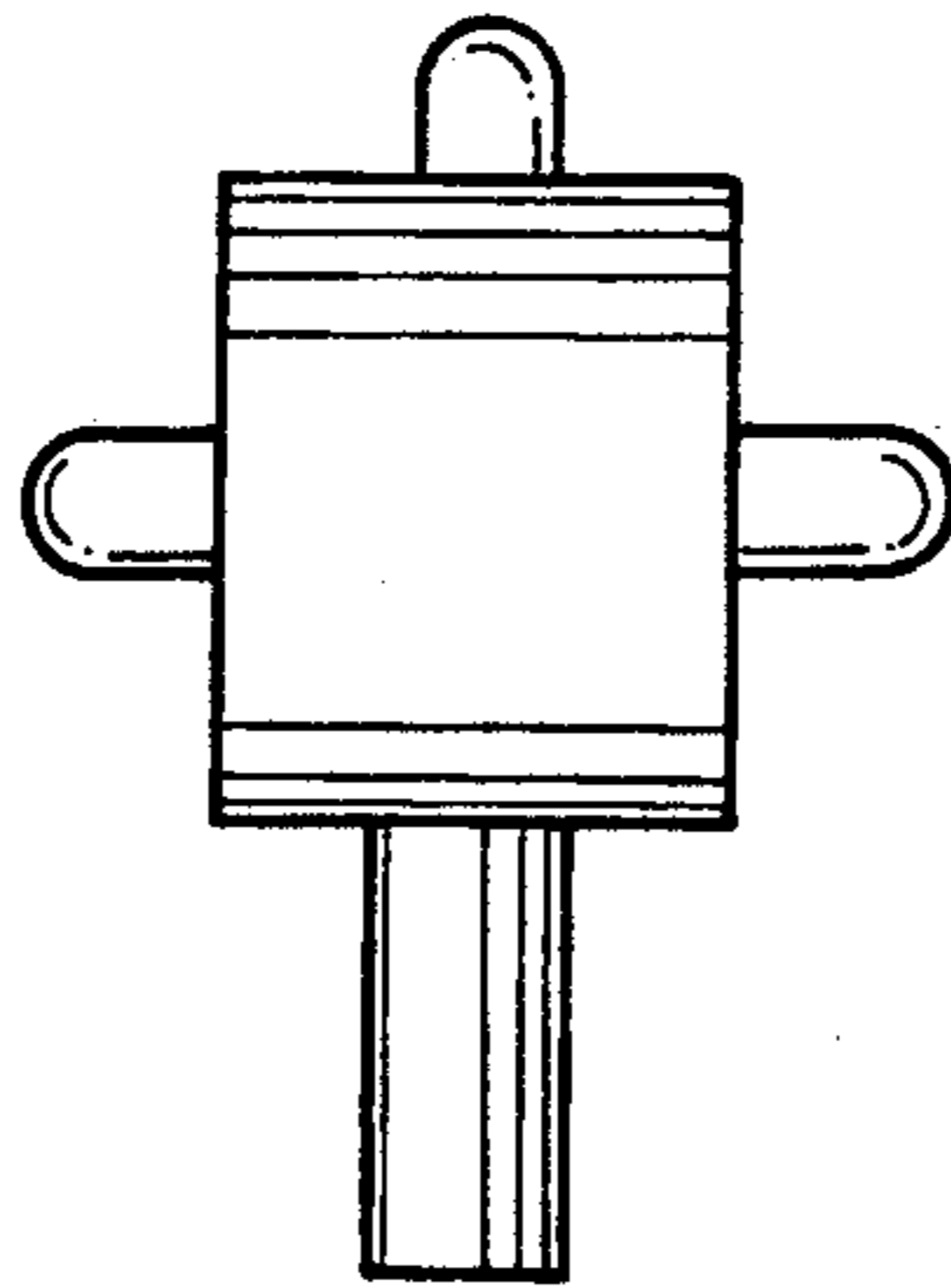

FIG. 5

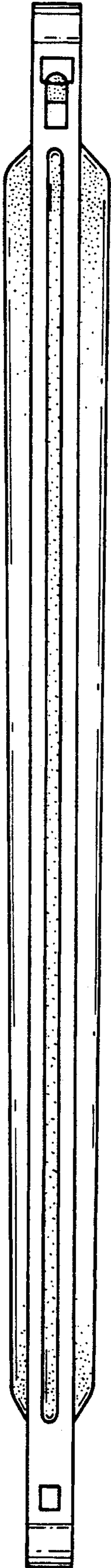

FIG. 6



FIG. 7

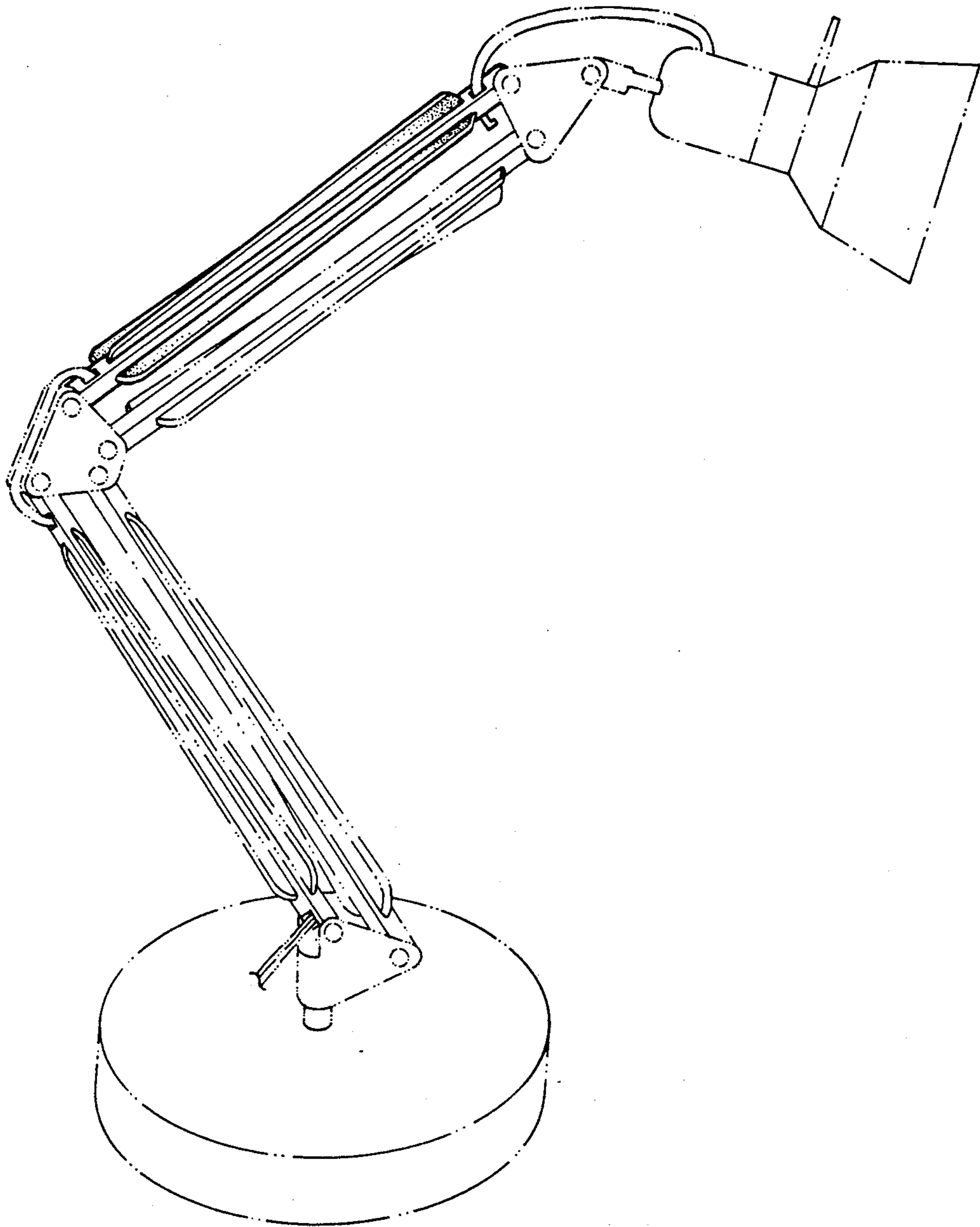

FIG. 8