



US00D335684S

United States Patent [19] Chan

[11] Patent Number: **Des. 335,684**
[45] Date of Patent: **** May 18, 1993**

[54] CALENDAR HOLDER

4,250,639 2/1981 Jarrant 40/107
4,457,088 7/1984 Sharber 40/120

[75] Inventor: **Eric P. Chan, New York, N.Y.**

Primary Examiner—Wallace R. Burke
Assistant Examiner—Marcus Jackson
Attorney, Agent, or Firm—Cohn, Powell & Hind

[73] Assignee: **American Trading & Production Corporation, Baltimore, Md.**

[**] Term: **14 Years**

[57] **CLAIM**

[21] Appl. No.: **814,284**

The ornamental design for a calendar holder, as shown and described.

[22] Filed: **Dec. 26, 1991**

DESCRIPTION

[52] U.S. Cl. **D19/20**

[58] Field of Search D19/20, 21, 22, 23,
D19/24, 25; 40/358, 107, 109, 116, 117, 122,
120; 283/2, 3, 4

FIG. 1 is an upper, front perspective view of a calendar holder showing my new design;
FIG. 2 is a lower, rear perspective view thereof;
FIG. 3 is a top plan view thereof;
FIG. 4 is a front elevational view thereof;
FIG. 5 is a bottom plan view thereof;
FIG. 6 is a side elevational view thereof;
FIG. 7 is a right side elevational view thereof; and,
FIG. 8 is a rear elevational view thereof.

[56] **References Cited**

U.S. PATENT DOCUMENTS

D. 323,188 1/1992 Evenson et al. D19/20
3,383,786 5/1968 McIntosh 40/120

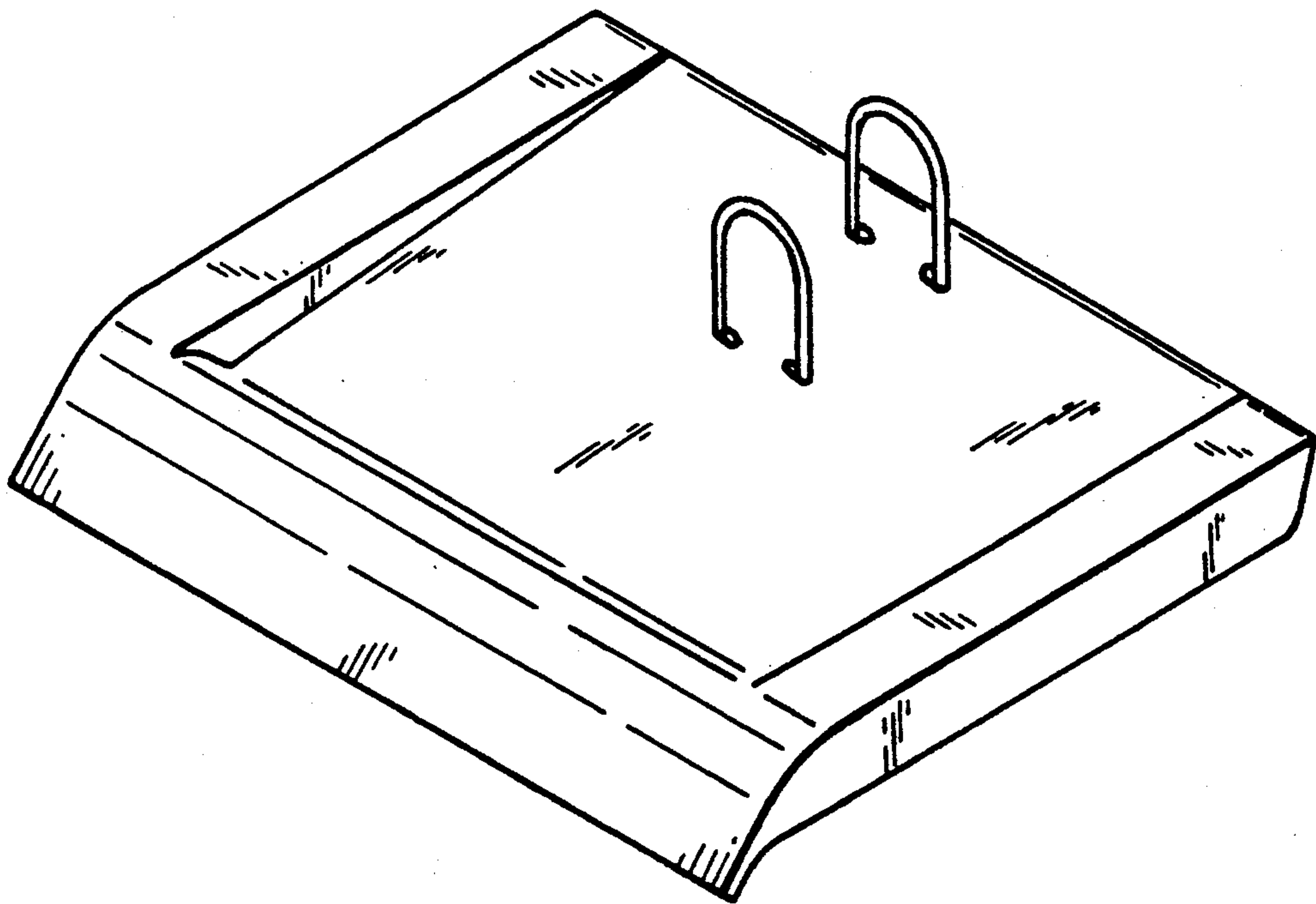

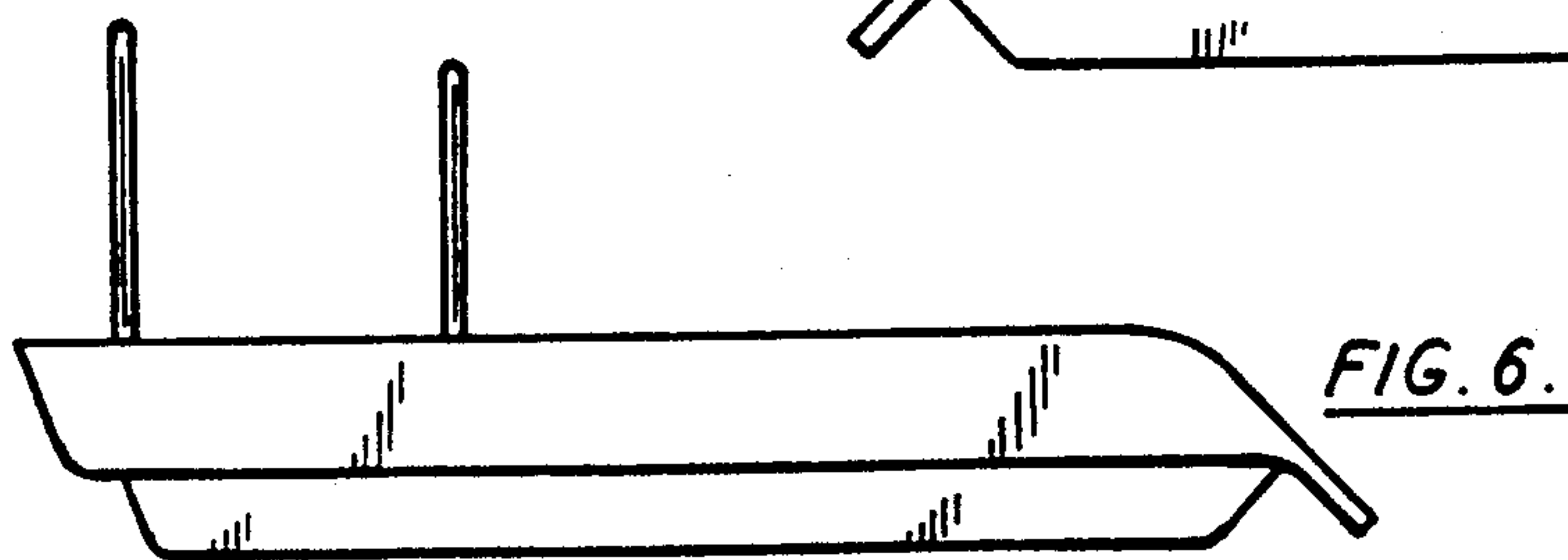
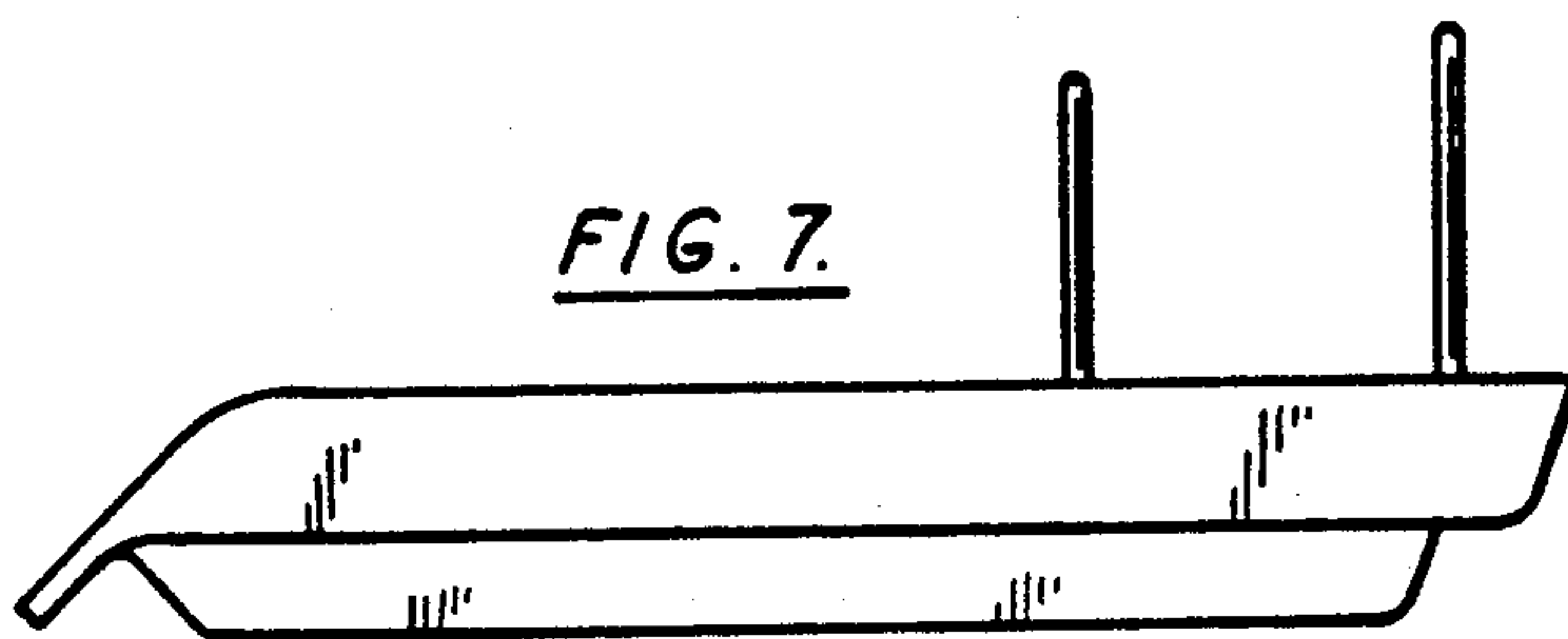
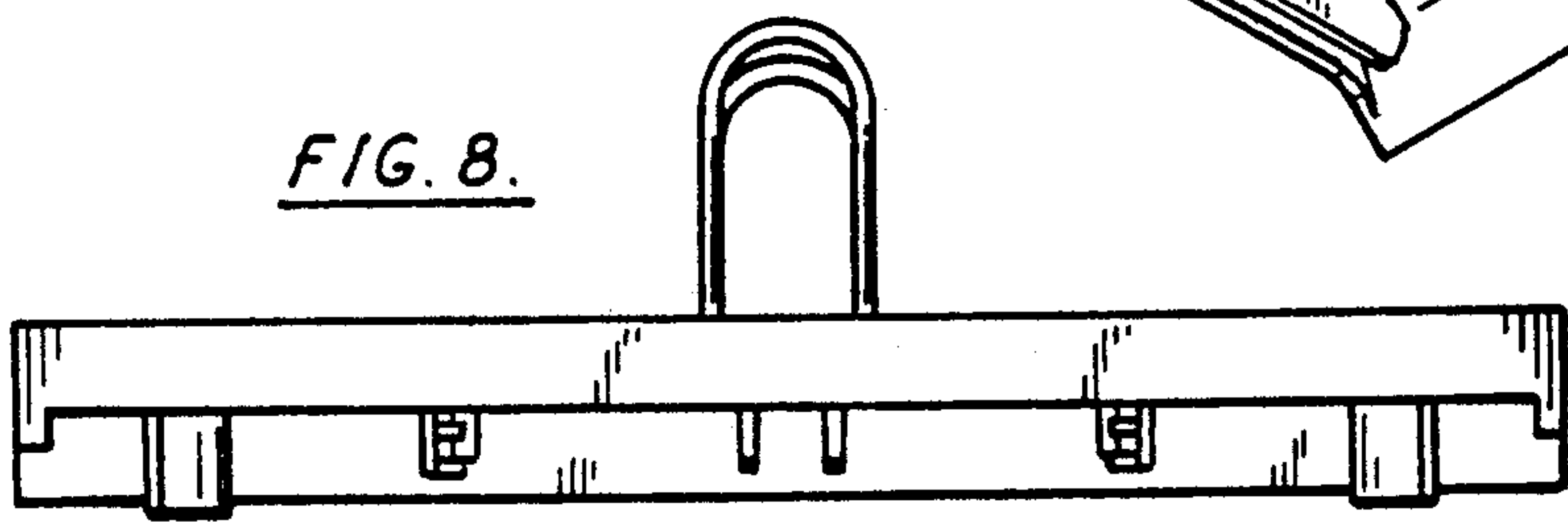
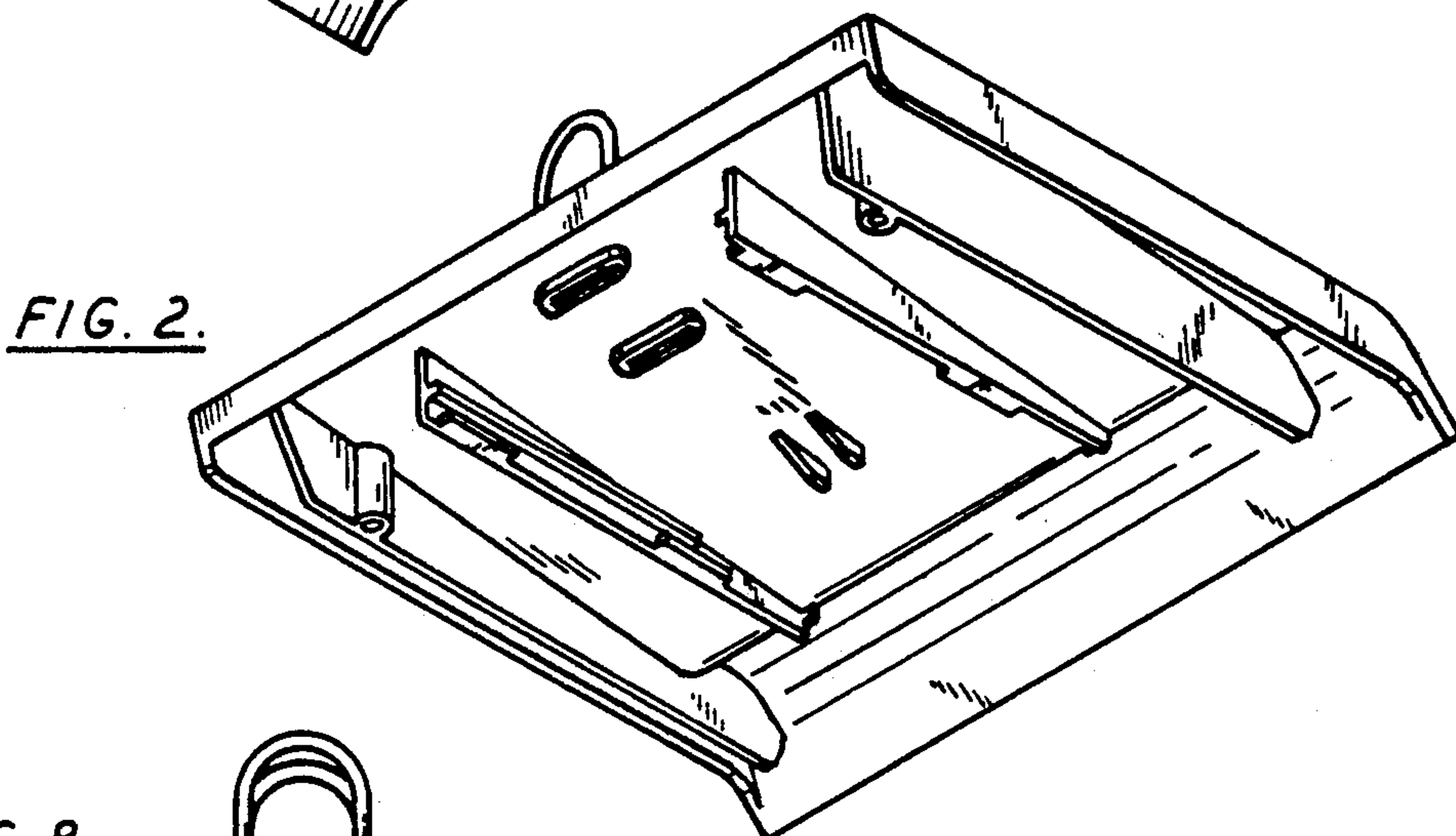
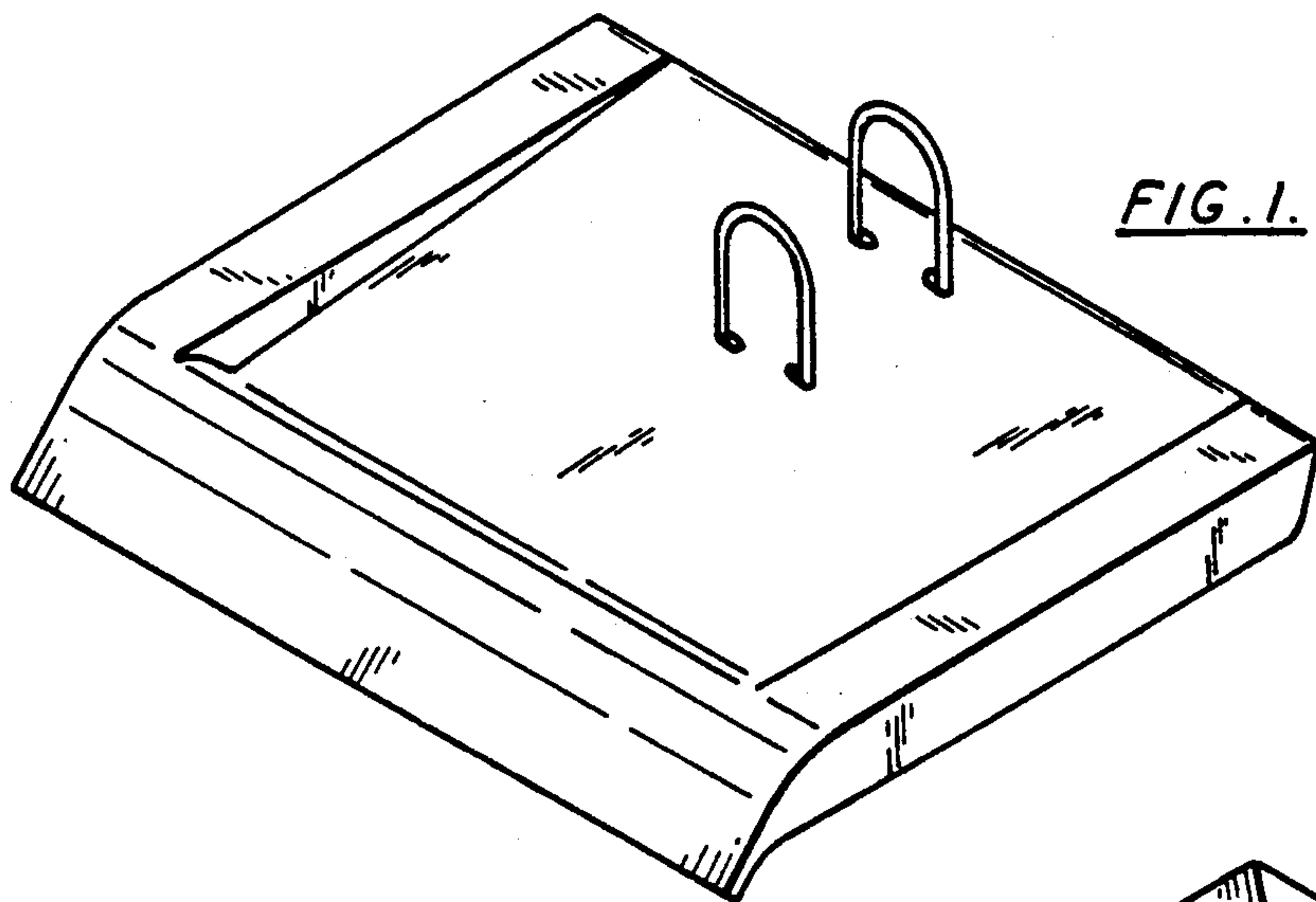

FIG. 3.

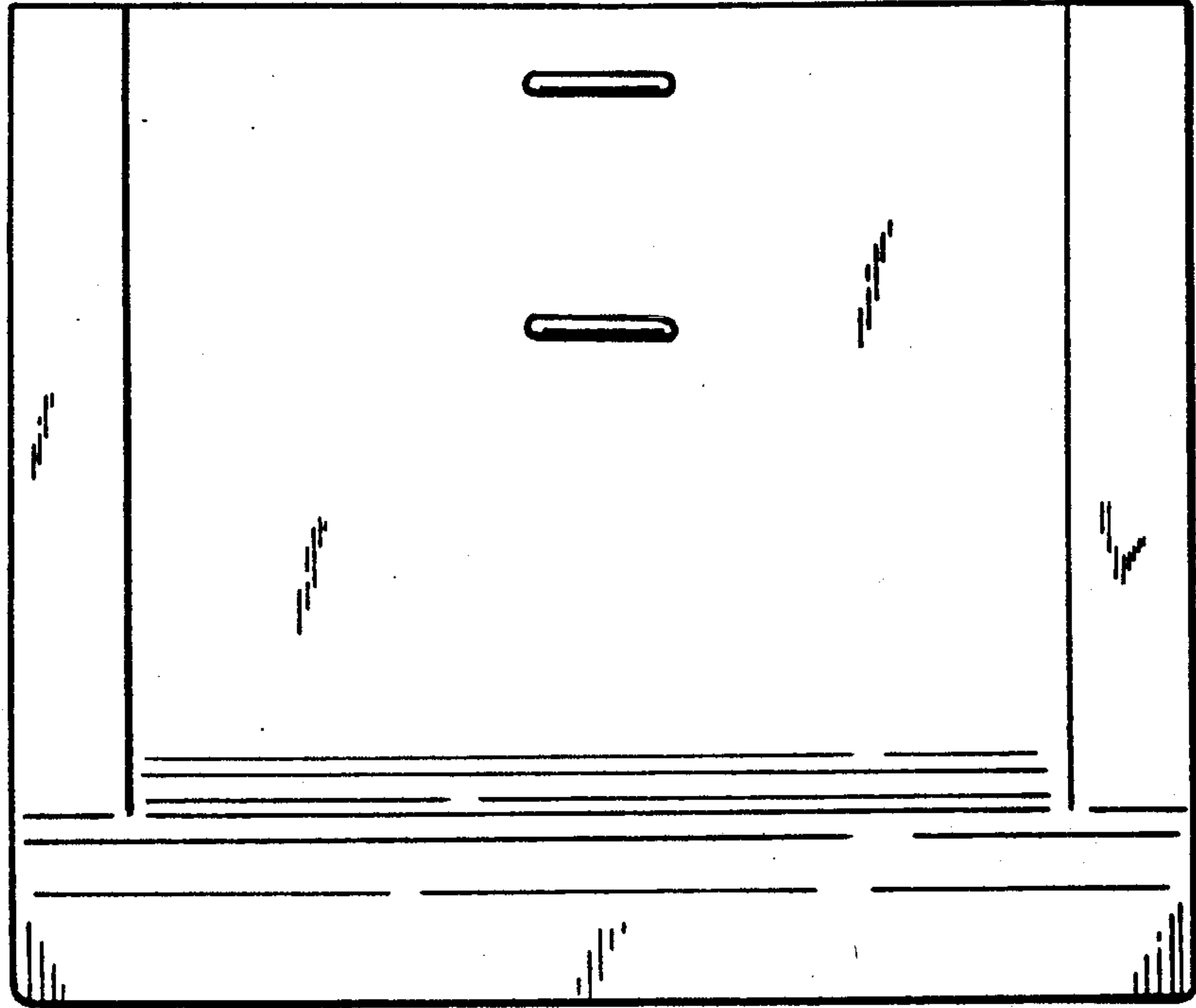

FIG. 4.

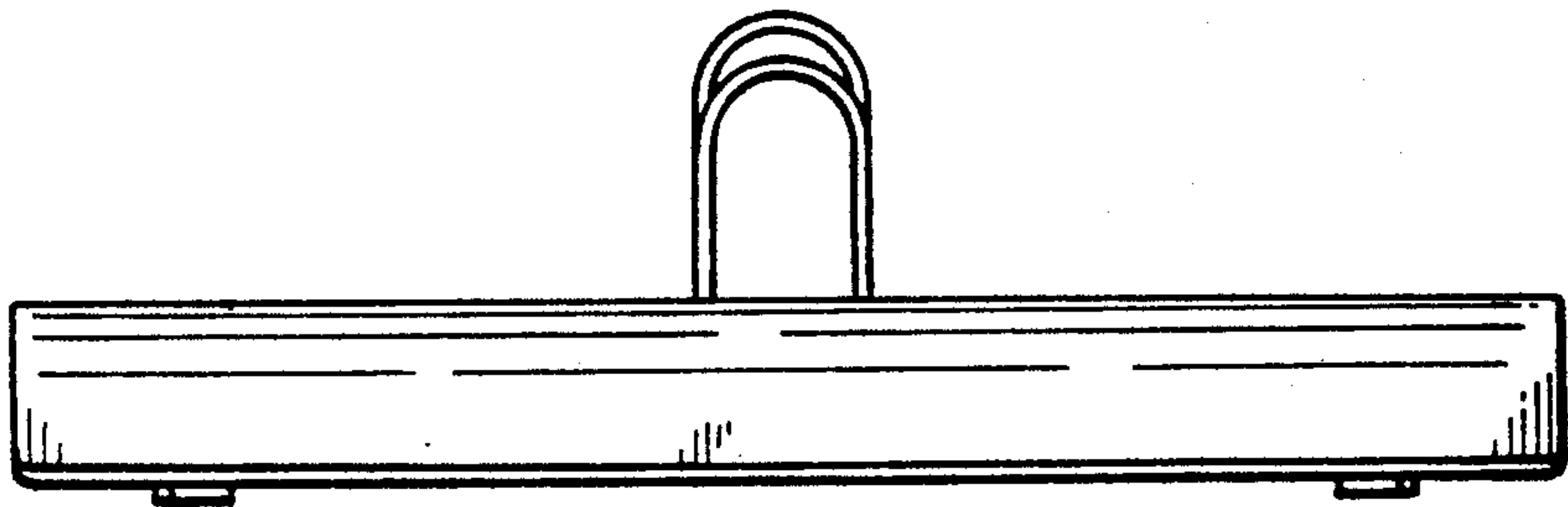

FIG. 5.

