



US00D335682S

# United States Patent [19]

[11] Patent Number: **Des. 335,682**

Penke et al.

[45] Date of Patent: **\*\* May 18, 1993**

[54] **DOCUMENT HANDLER FOR COPIER OR PRINTER**

[56] **References Cited**

**U.S. PATENT DOCUMENTS**

D. 314,789 2/1991 Hirata et al. .... D18/36

[75] Inventors: **Mark S. Penke**, West Henrietta;  
**Robert E. Kalvitis**, Fairport; **William T. Clark, III**, West Henrietta, all of N.Y.; **Marland Chow**, Oceanside, Calif.; **Leonard V. Gates**, Widford Nr. Ware, United Kingdom; **Hideyuki Matsubara**; **Chikako Sanaka**, both of Yokohama, Japan

**OTHER PUBLICATIONS**

Xerox Brochure, Mar. 1986, paper handler top of machine in front.

*Primary Examiner*—Alan P. Douglas  
*Assistant Examiner*—Ann Hunt

[73] Assignee: **Xerox Corporation**, Stamford, Conn.

[57] **CLAIM**

The ornamental design for a document handler for copier or printer, as shown.

[\*\*] Term: **14 Years**

**DESCRIPTION**

[21] Appl. No.: **785,683**

FIG. 1 is a frontal perspective view of a document handler for copier or printer showing our new design; FIG. 2 is a front view; FIG. 3 is a right side view; FIG. 4 is a rear view; FIG. 5 is a left side view; and, FIG. 6 is a top view.

[22] Filed: **Oct. 31, 1991**

[52] U.S. Cl. .... **D18/49**

[58] Field of Search ..... **D18/36-44,**  
**D18/46-49; 271/3, 3.1, 8.1, 9; 355/200, 308,**  
**309; 358/498**

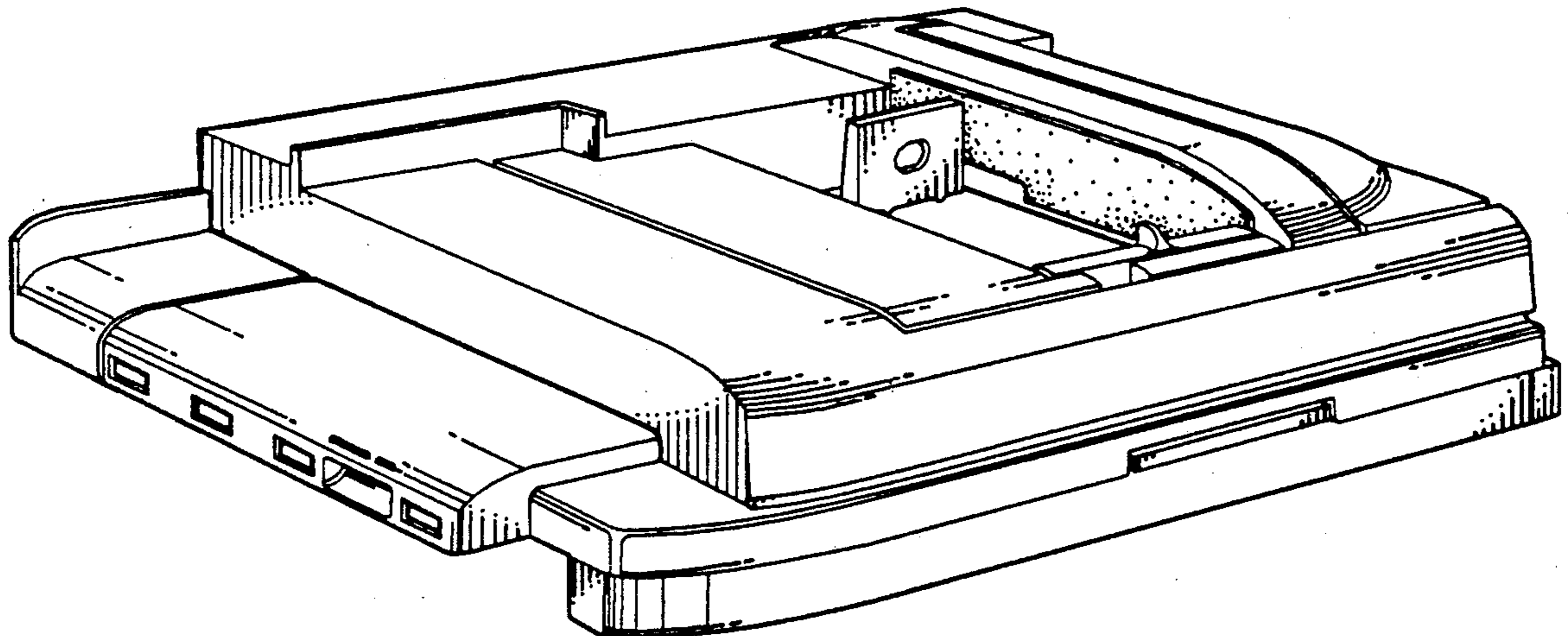

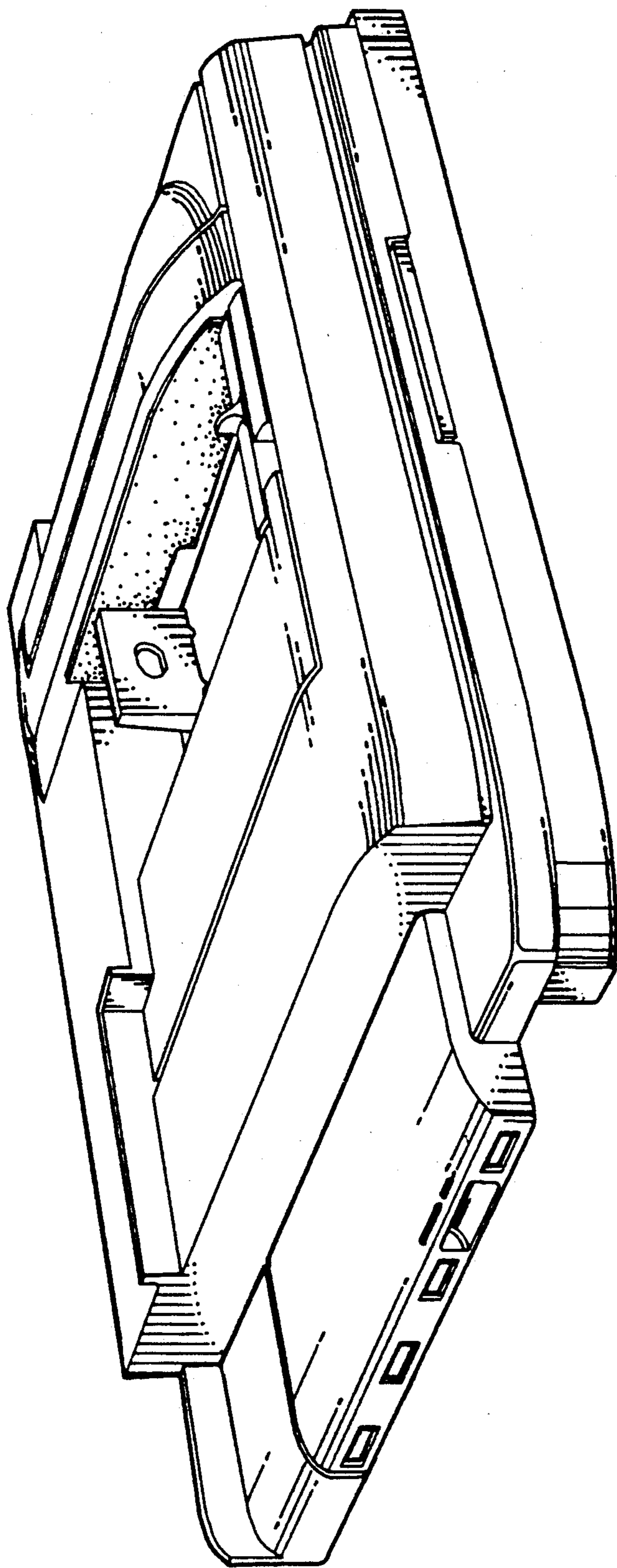
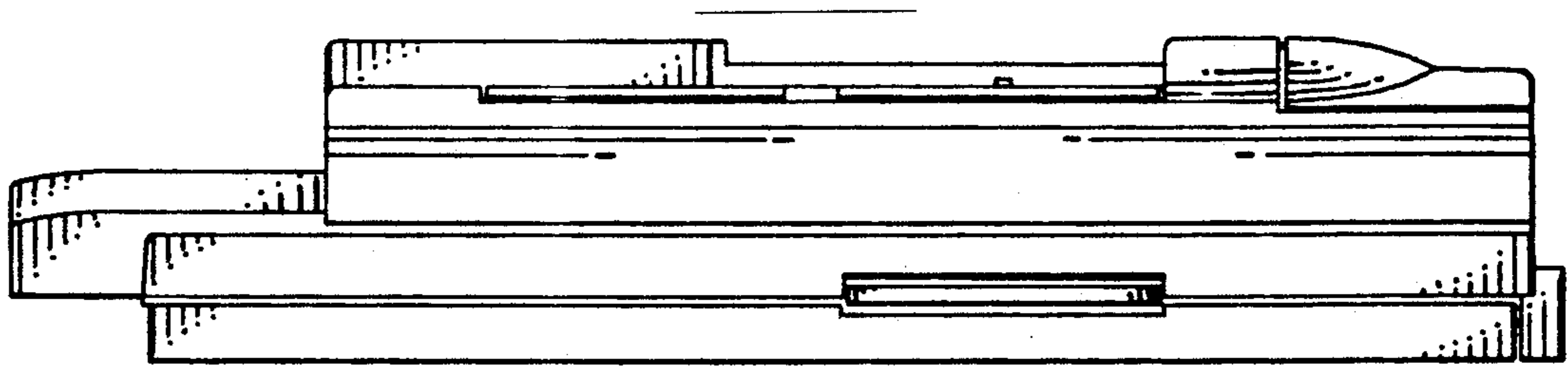
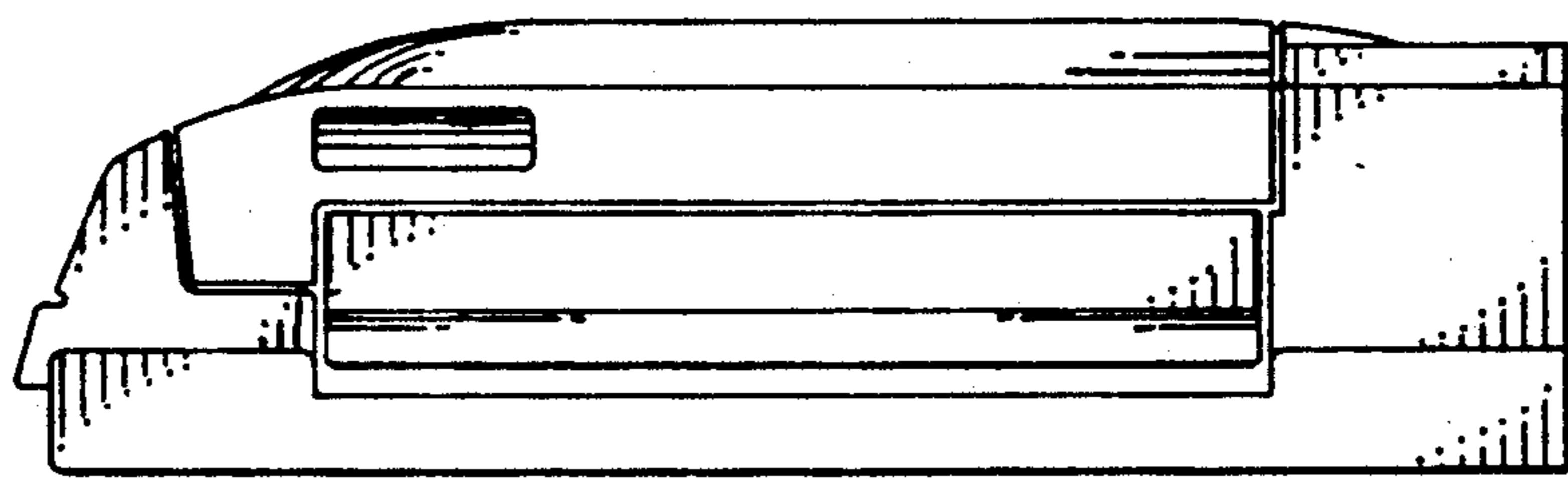

FIG. 1



**FIG. 2**



**FIG. 3**

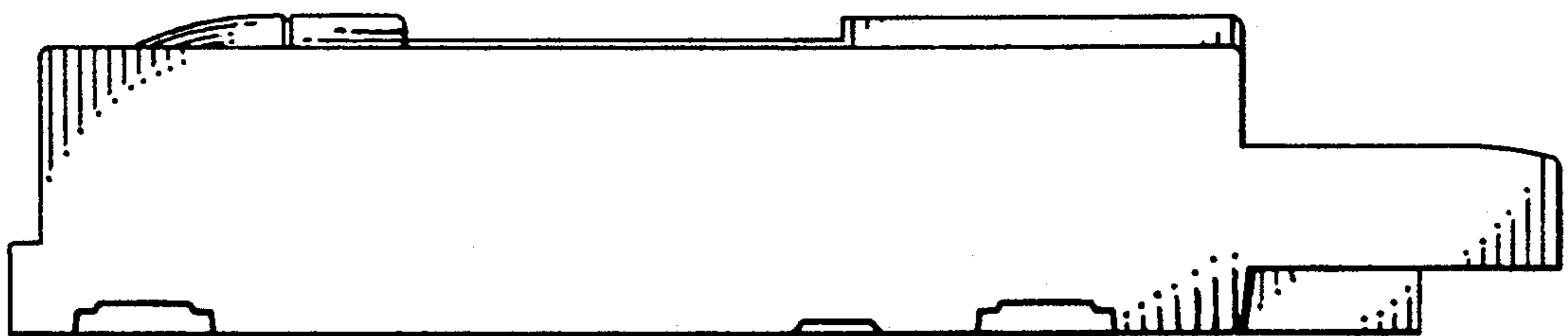

**FIG. 4**

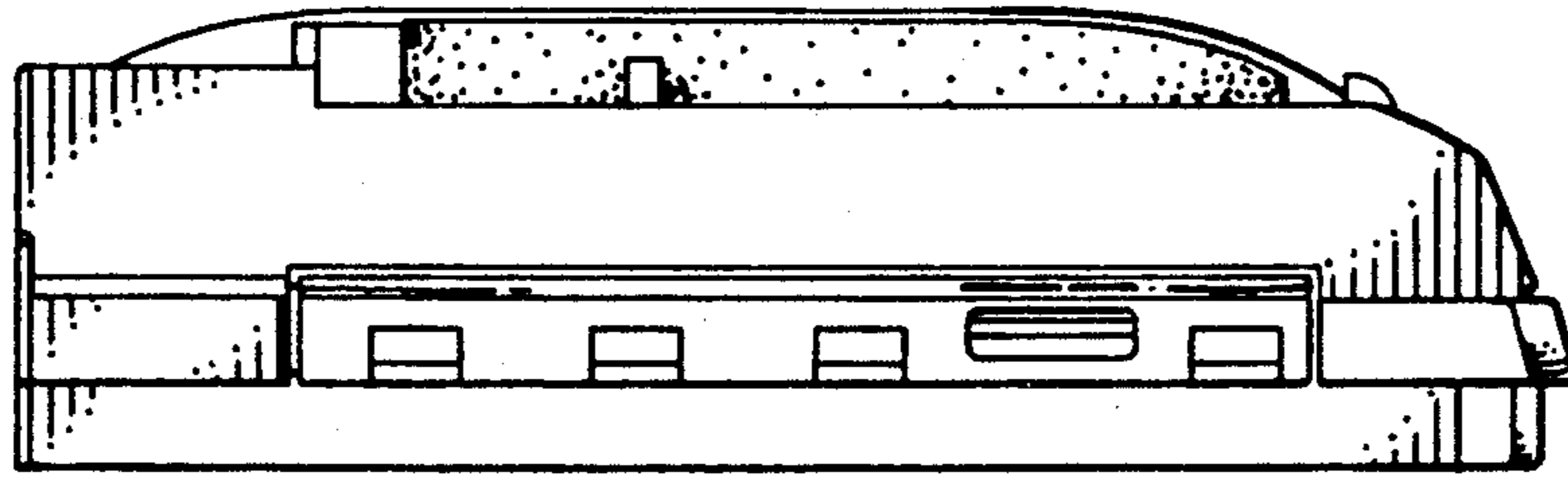

**FIG. 5**

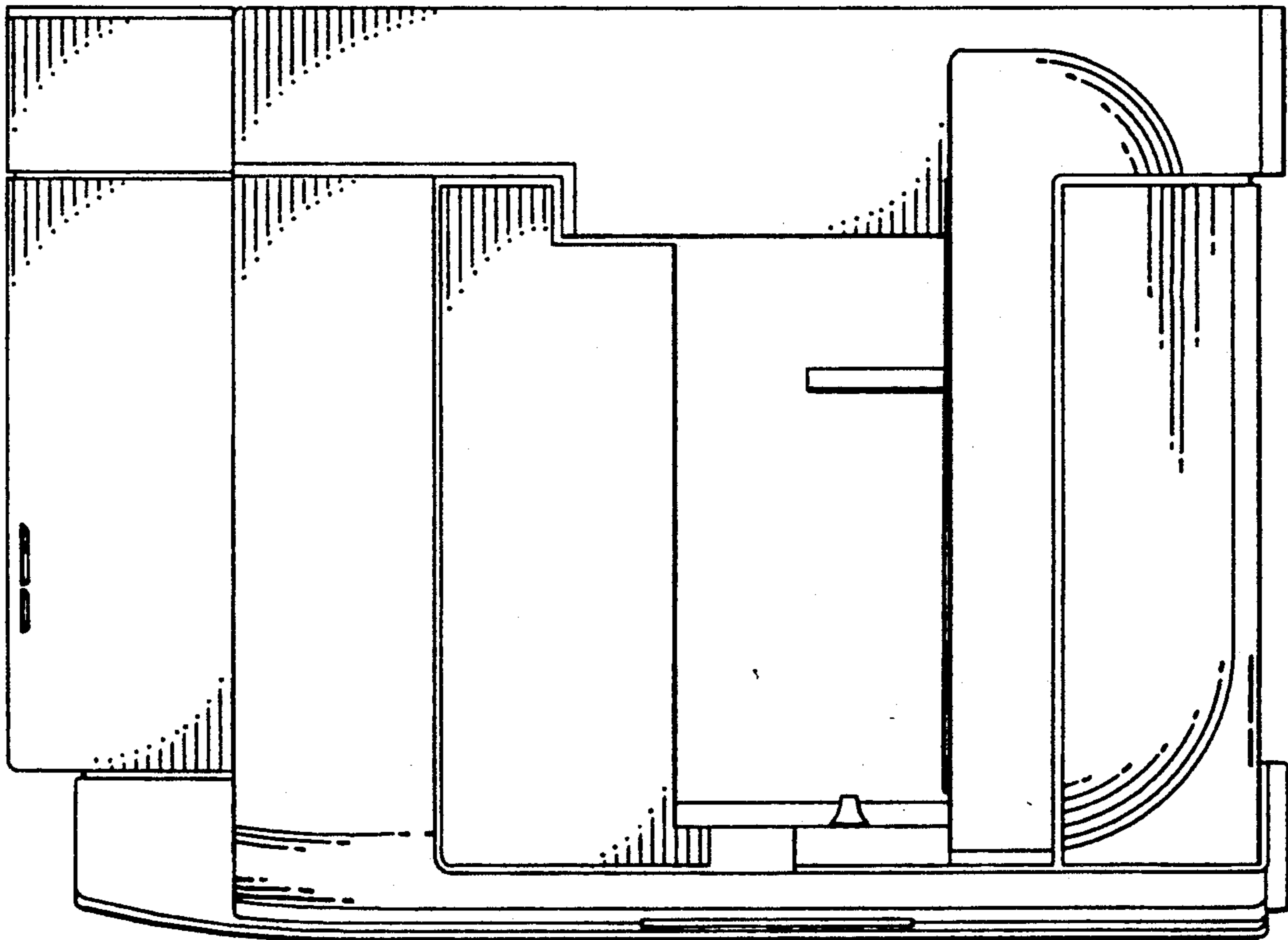

**FIG. 6**