



US00D335673S

United States Patent [19]

[11] Patent Number: **Des. 335,673**

Wulc

[45] Date of Patent: **** May 18, 1993**

- [54] **FUEL DISPENSING CONSOLE**
- [75] Inventor: **Stanley S. Wulc, Rydal, Pa.**
- [73] Assignee: **William M. Wilson's Sons, Inc., Lansdale, Pa.**
- [**] Term: **14 Years**
- [21] Appl. No.: **813,300**
- [22] Filed: **Dec. 18, 1991**
- [52] U.S. Cl. **D15/9.1**
- [58] Field of Search **D15/9.1-9.2; 222/24-28, 30, 37, 129; D20/1; 137/234.6; D10/96, 102**

Attorney, Agent, or Firm—Baker & Daniels

[57] CLAIM

The ornamental design for a fuel dispensing console, as shown and described.

DESCRIPTION

FIG. 1 is a perspective view of a fuel dispensing console showing my new design;
 FIG. 2 is a front elevational view thereof;
 FIG. 3 is a rear elevational view thereof;
 FIG. 4 is a side elevational view of my fuel dispensing console as viewed from the left side of FIG. 2;
 FIG. 5 is a side elevational view of my fuel dispensing console as viewed from the right side of FIG. 2;
 FIG. 6 is a top plan view thereof;
 FIG. 7 is a perspective view of a fuel dispensing console showing a second embodiment of my new design;
 FIG. 8 is a front elevational view of FIG. 7;
 FIG. 9 is a rear elevational view of FIG. 7;
 FIG. 10 is a perspective view of a fuel dispensing console showing a third embodiment of my new design;
 FIG. 11 is a front elevational view of FIG. 10;
 FIG. 12 is a rear elevational view of FIG. 10;
 FIG. 13 is a perspective view of a fuel dispensing console showing a fourth embodiment of my new design;
 FIG. 14 is a front elevational view of FIG. 13;
 FIG. 15 is a rear elevational view of FIG. 13;
 FIG. 16 is a perspective view of a fuel dispensing console showing a fifth embodiment of my new design;
 FIG. 17 is a front elevational view of FIG. 16;
 FIG. 18 is a rear elevational view of FIG. 16;
 FIG. 19 is a side elevational view of my fuel dispensing console as viewed from the left side of FIG. 17; and,
 FIG. 20 is a side elevational view of my fuel dispensing console as viewed from the right side of FIG. 17.
 The side elevational view and top plan views to the second through fourth embodiments are essentially the same as FIGS. 4-6.

[56] **References Cited**
U.S. PATENT DOCUMENTS

D. 194,946	4/1963	Hunt	D52/2
D. 194,947	4/1963	Hunt	D52/2
D. 194,948	4/1963	Hunt	D52/2
D. 232,967	9/1974	Kennedy	D23/1
D. 234,873	4/1975	Wheeler	D20/2
D. 237,101	10/1975	Loy et al.	D20/2
D. 251,270	3/1979	Loy et al.	D15/9.1
D. 252,115	12/1981	Rowan et al.	D15/9.2
D. 258,441	3/1981	Gray	D15/9.2
D. 262,970	2/1982	Rowan et al.	D15/9.2
D. 262,971	2/1982	Robinson, Jr. et al.	D15/9.2
D. 264,471	5/1982	Rowan et al.	D15/9.2
D. 265,092	6/1982	Robinson, Jr. et al.	D15/9.2
D. 272,629	2/1984	Monigle et al.	D15/9.1
D. 281,427	11/1985	Baffo et al.	D15/9.2
D. 299,827	2/1989	Crum et al.	D15/9.1
D. 301,147	5/1989	Bass	D15/9.1
D. 301,342	5/1989	Mittermaier et al.	D15/9.1
D. 309,144	7/1990	Austin et al.	D15/9.2
4,576,312	3/1986	Swick, Jr.	D15/9.2
4,930,665	6/1990	Devine	222/28

Primary Examiner—A. Hugo Word
Assistant Examiner—R. Seifert

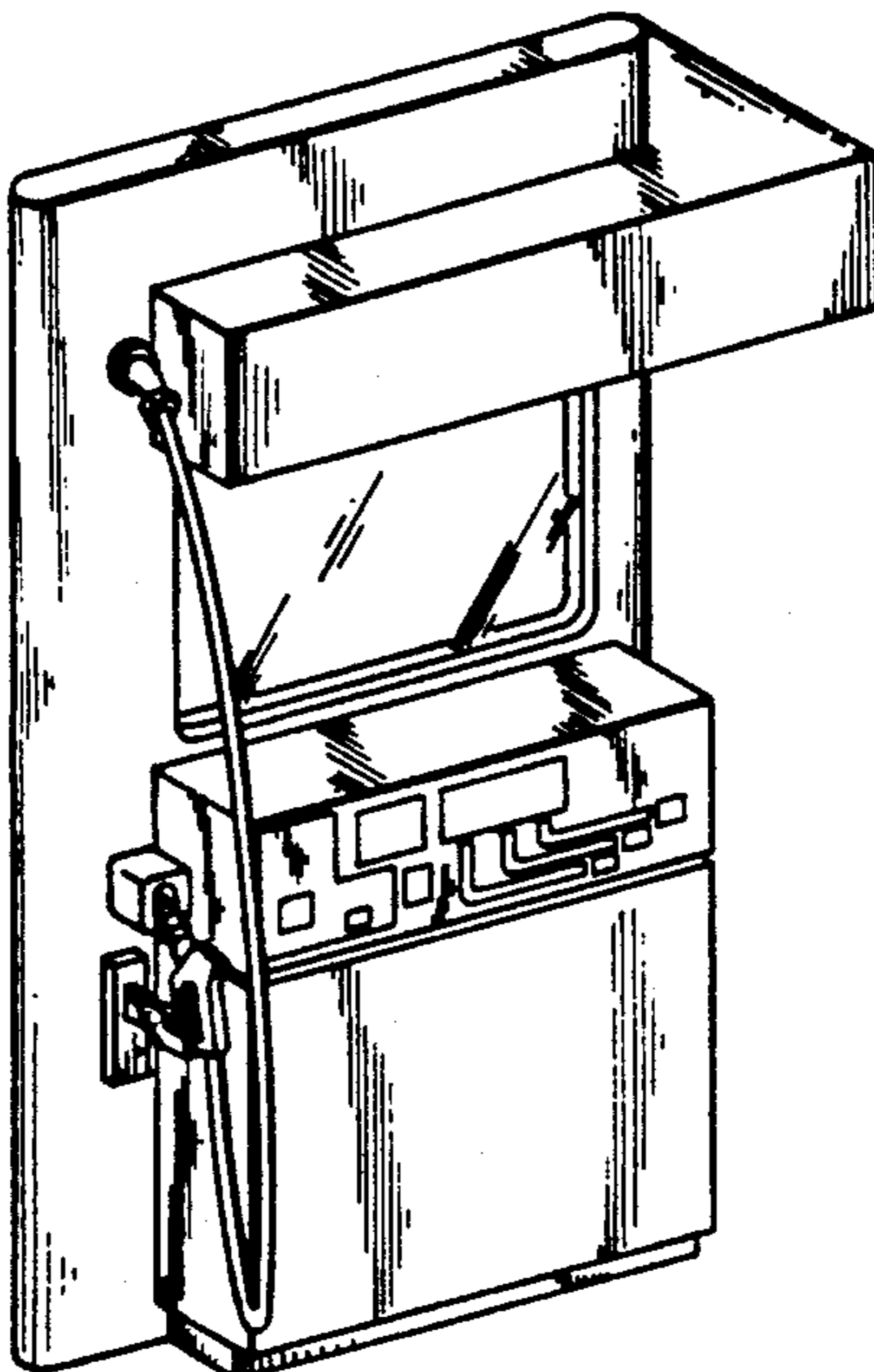

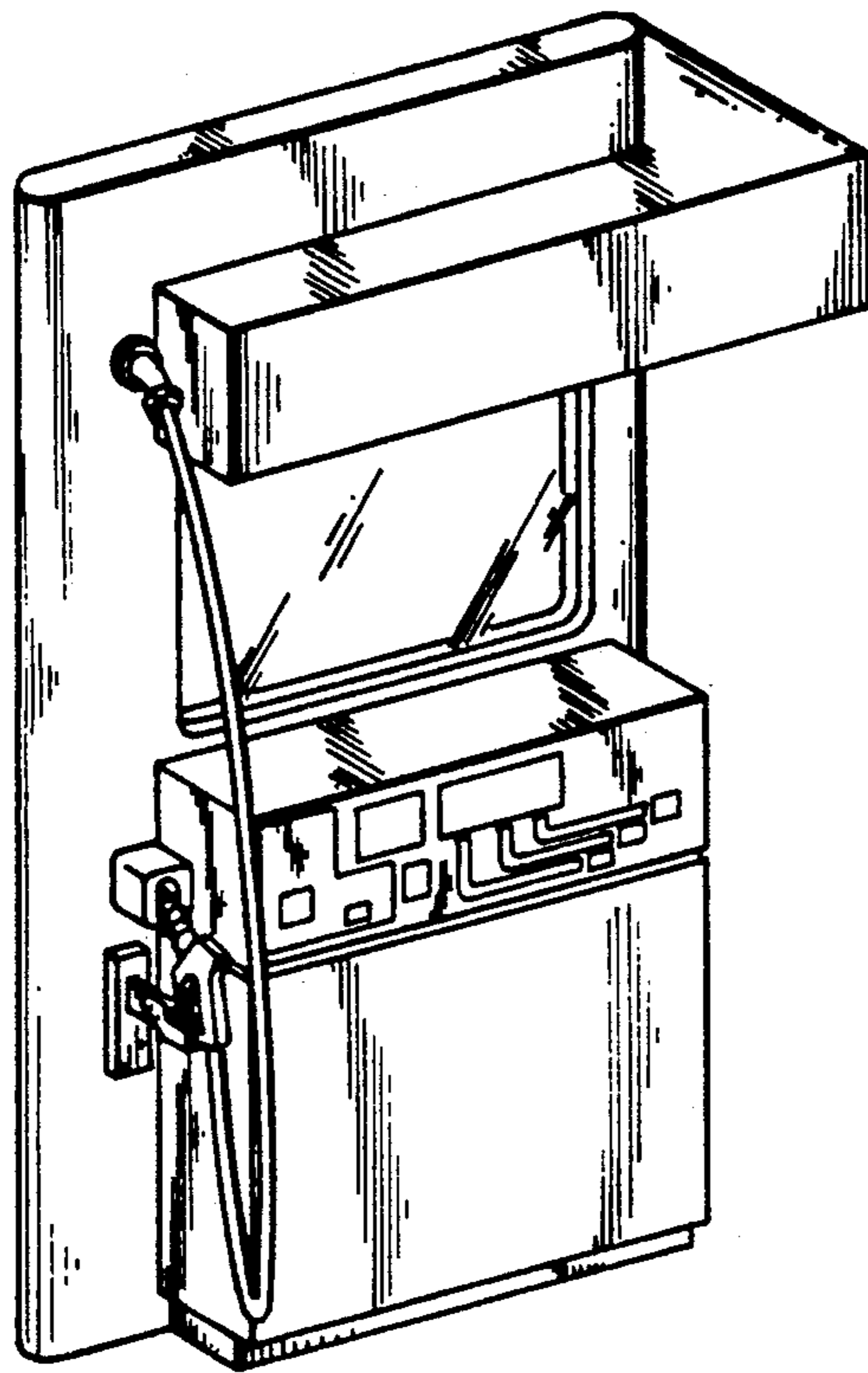

FIG. 1

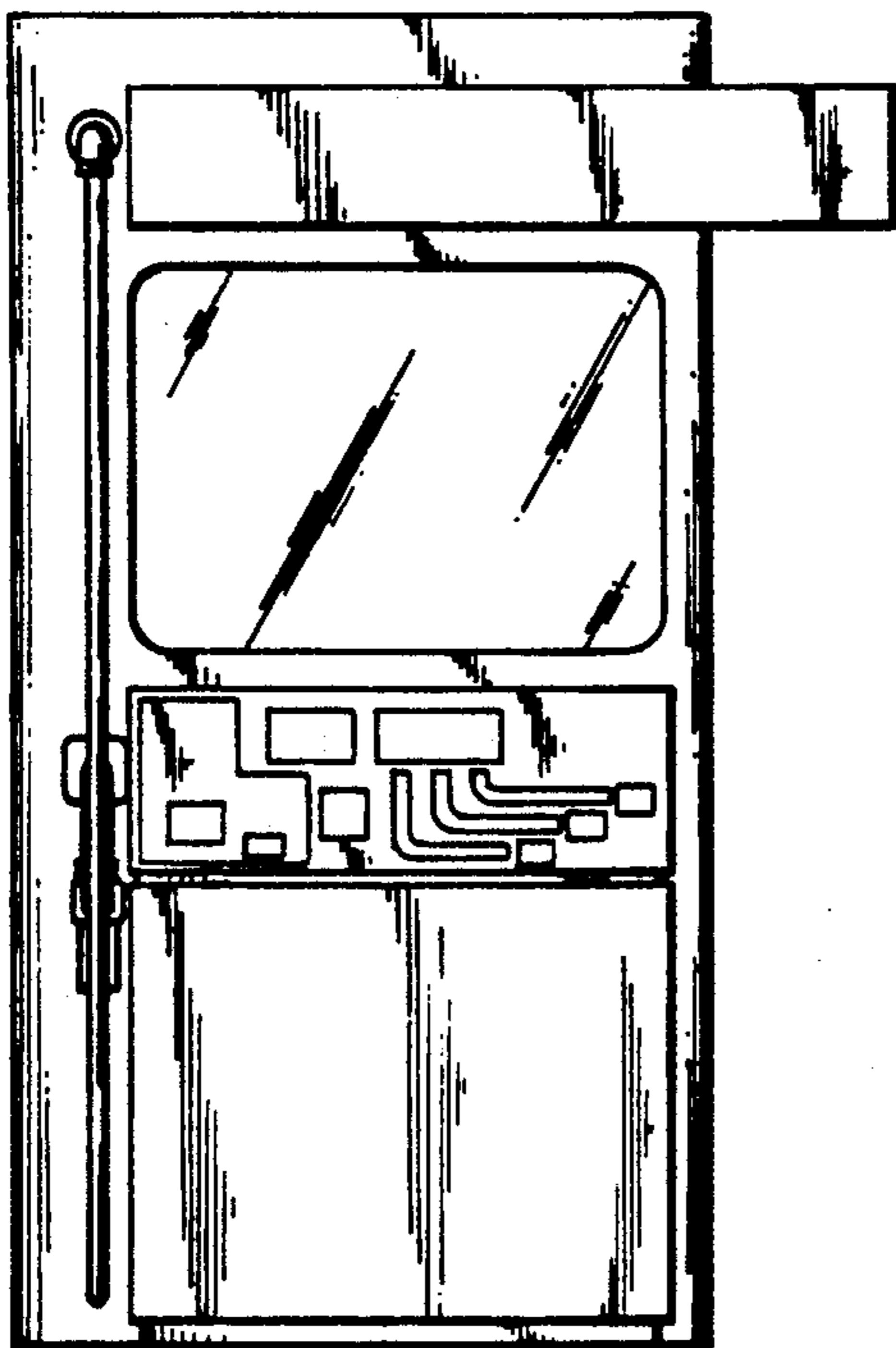

FIG. 2

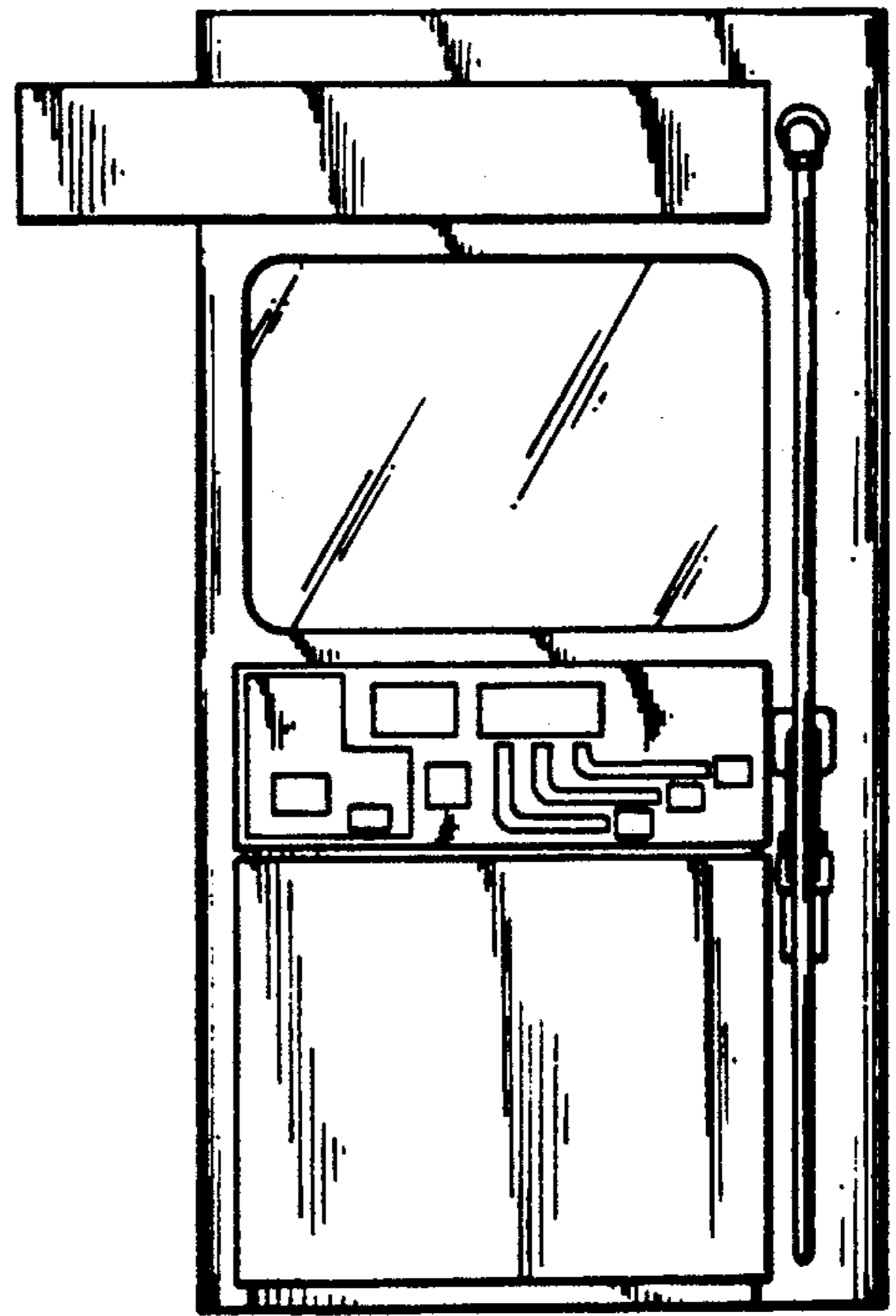

FIG. 3

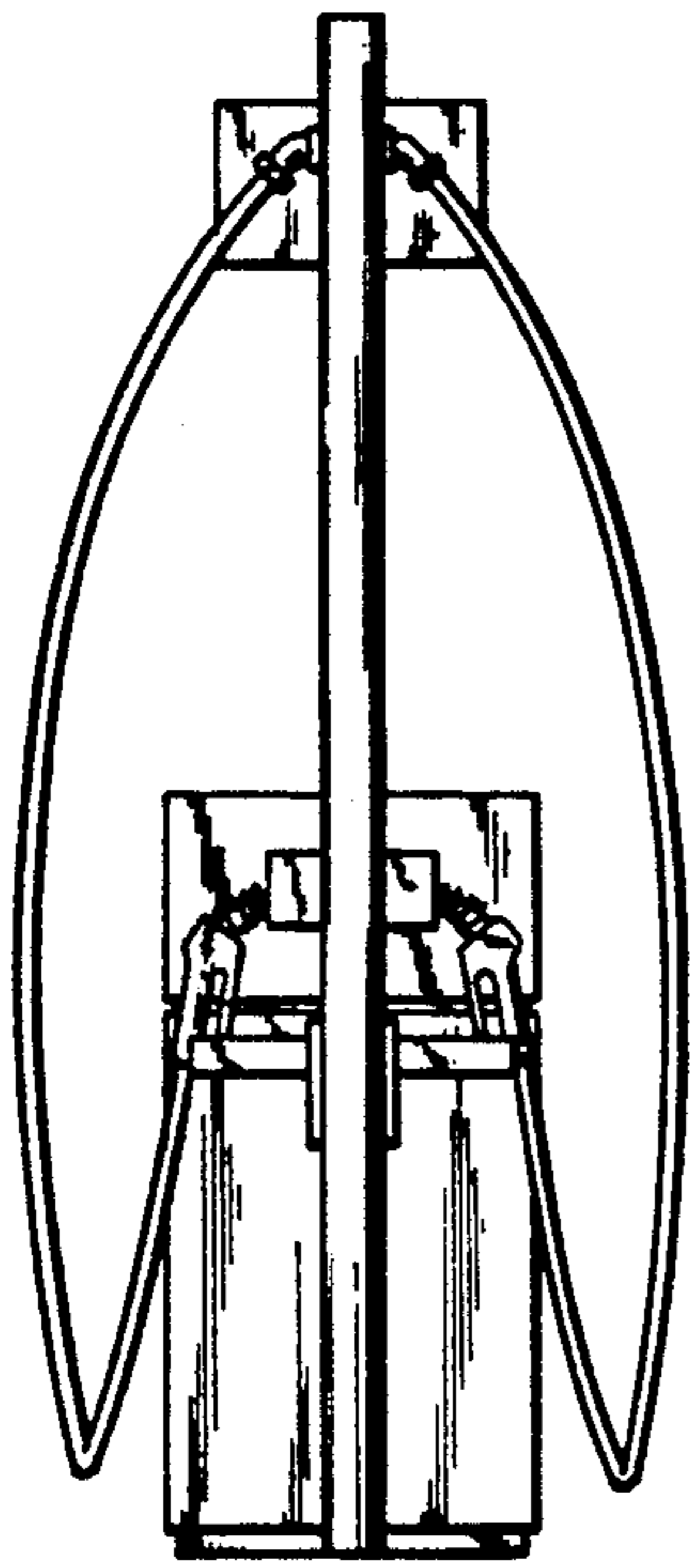

FIG. 4

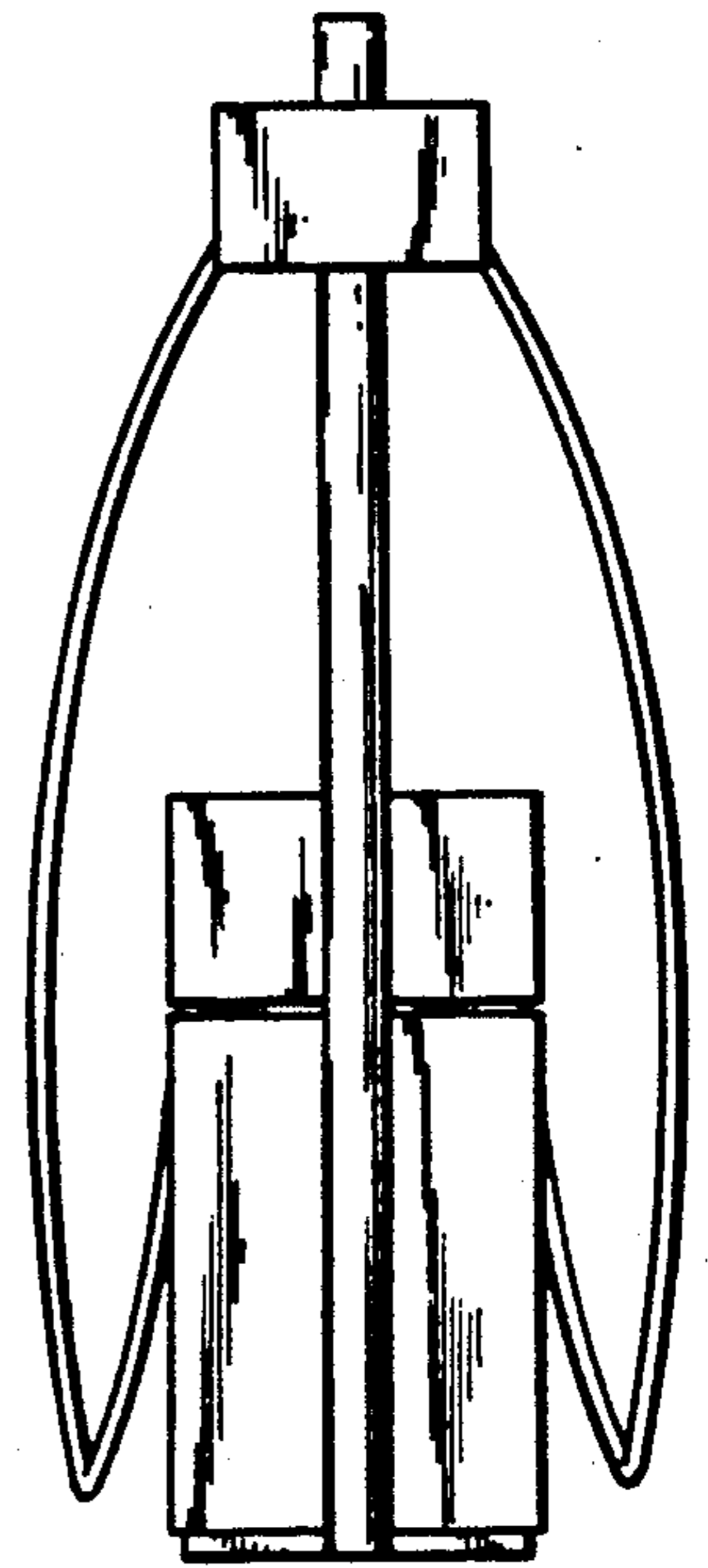

FIG. 5

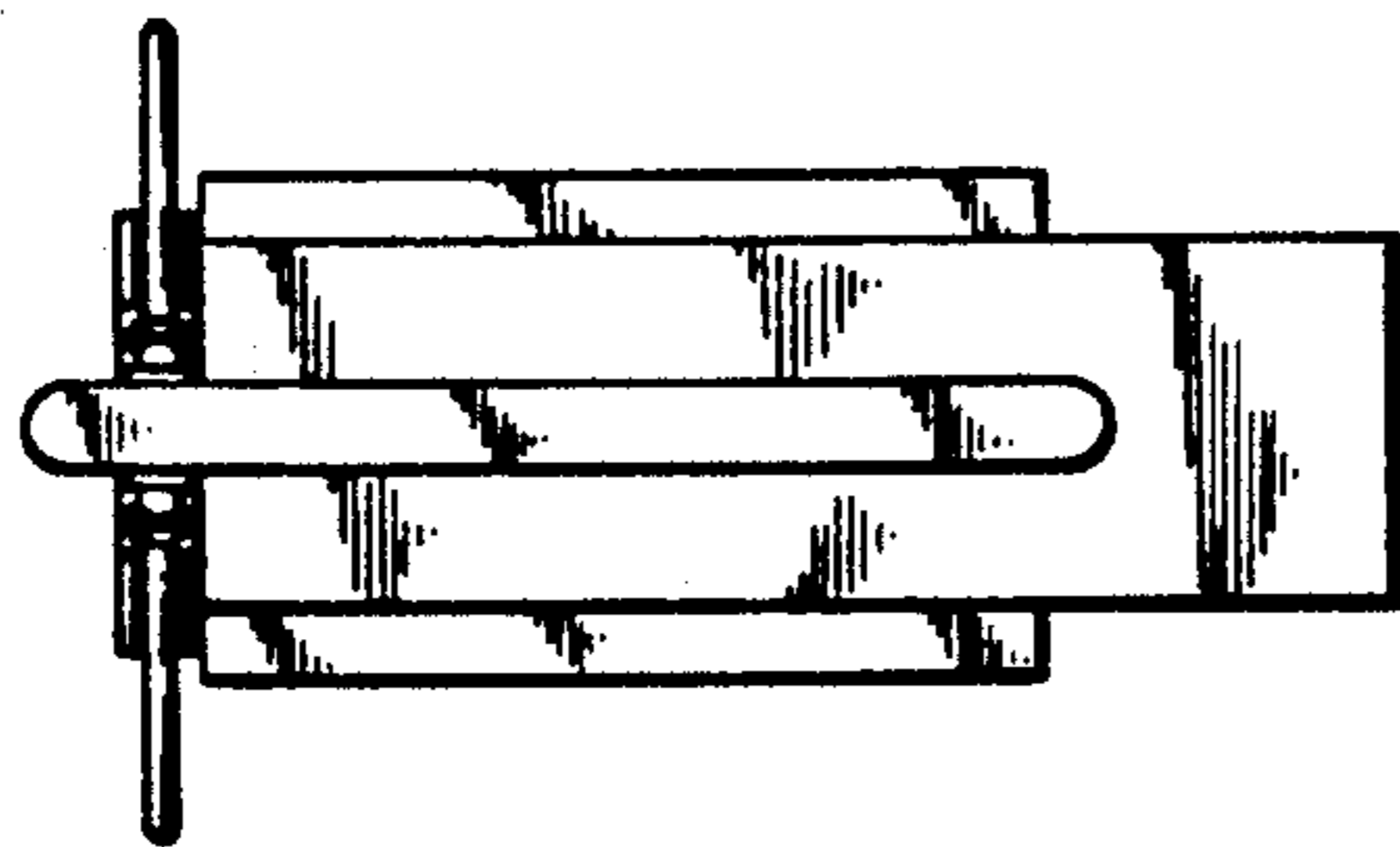

FIG. 6

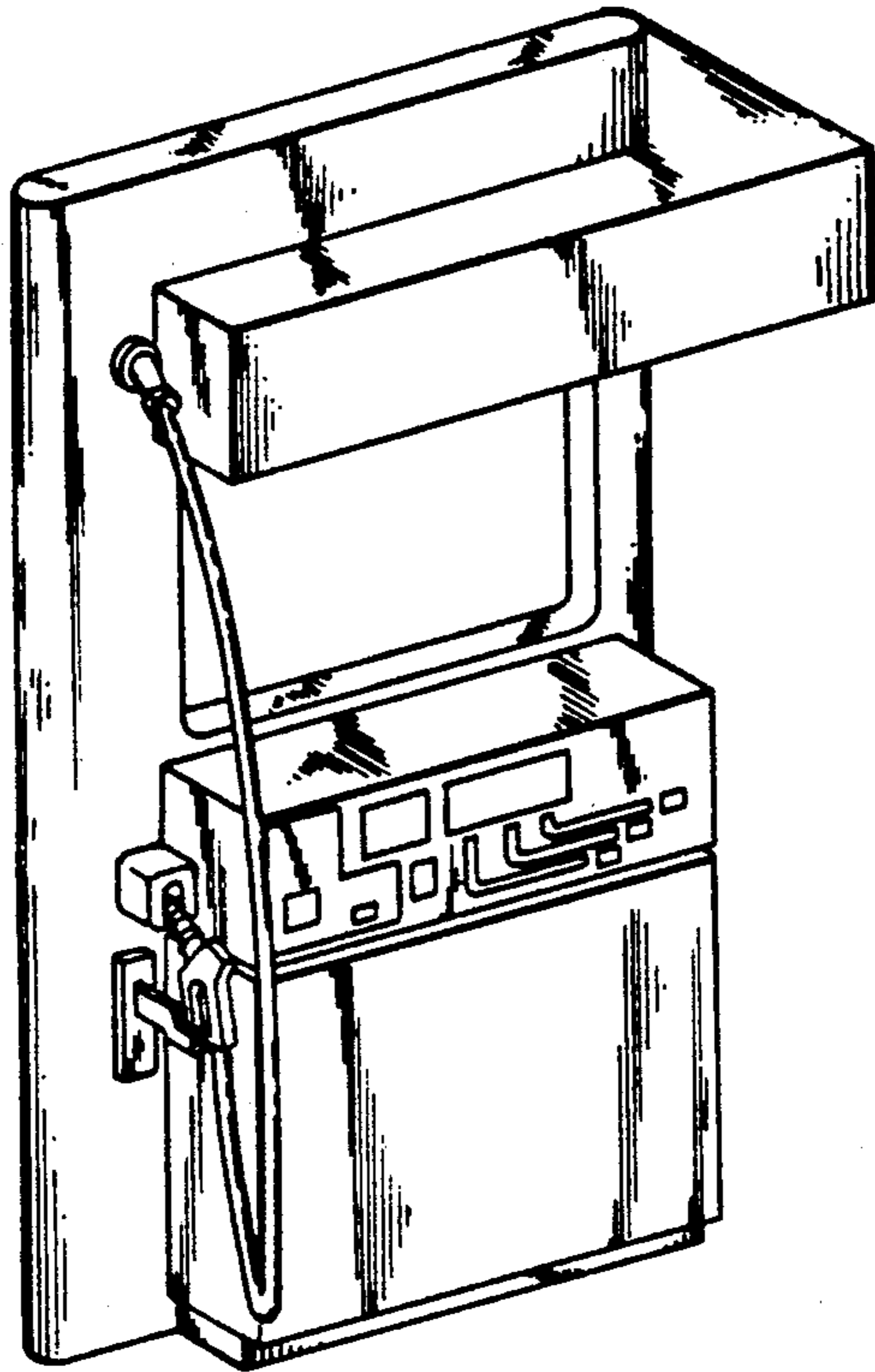

FIG. 7

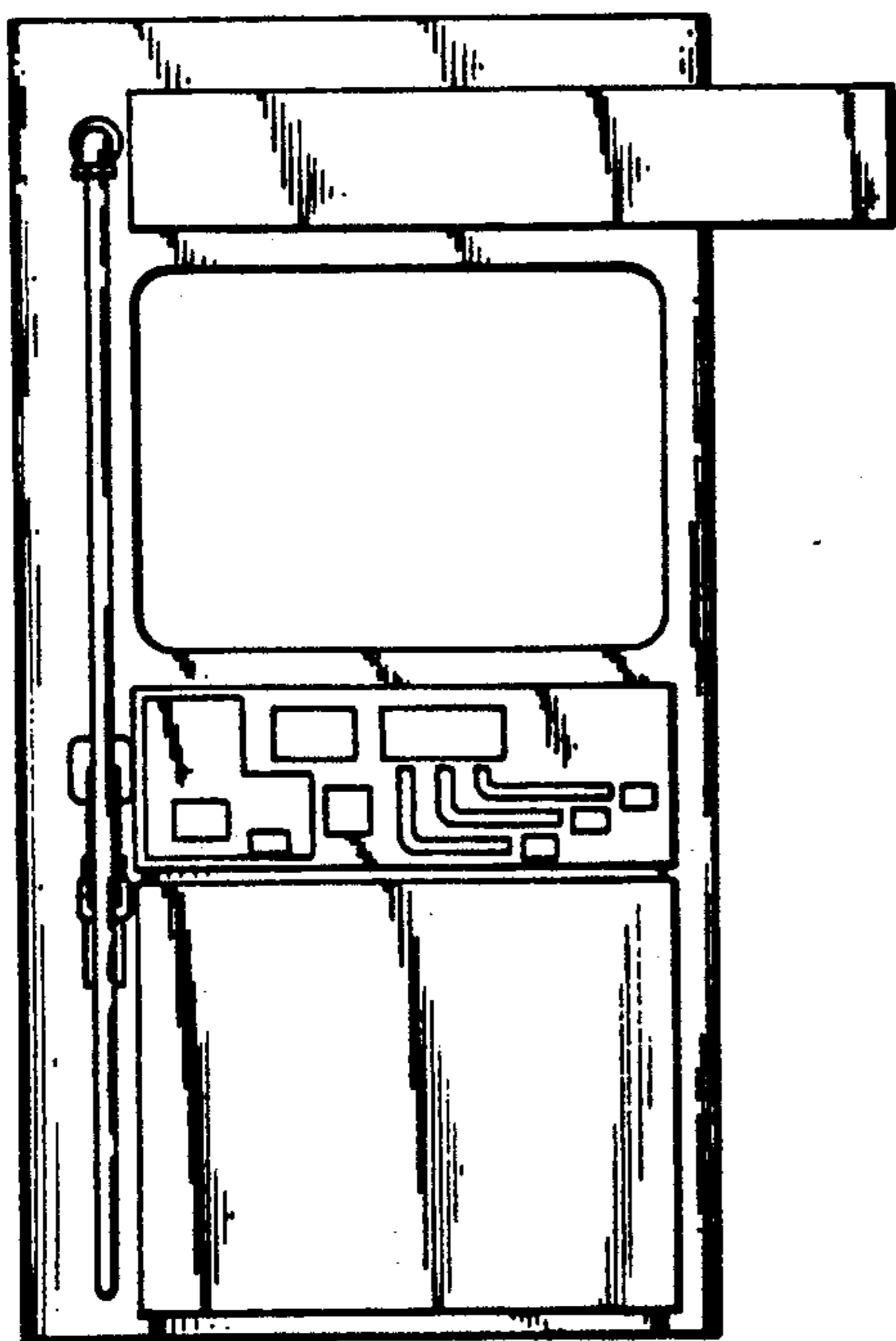

FIG. 8

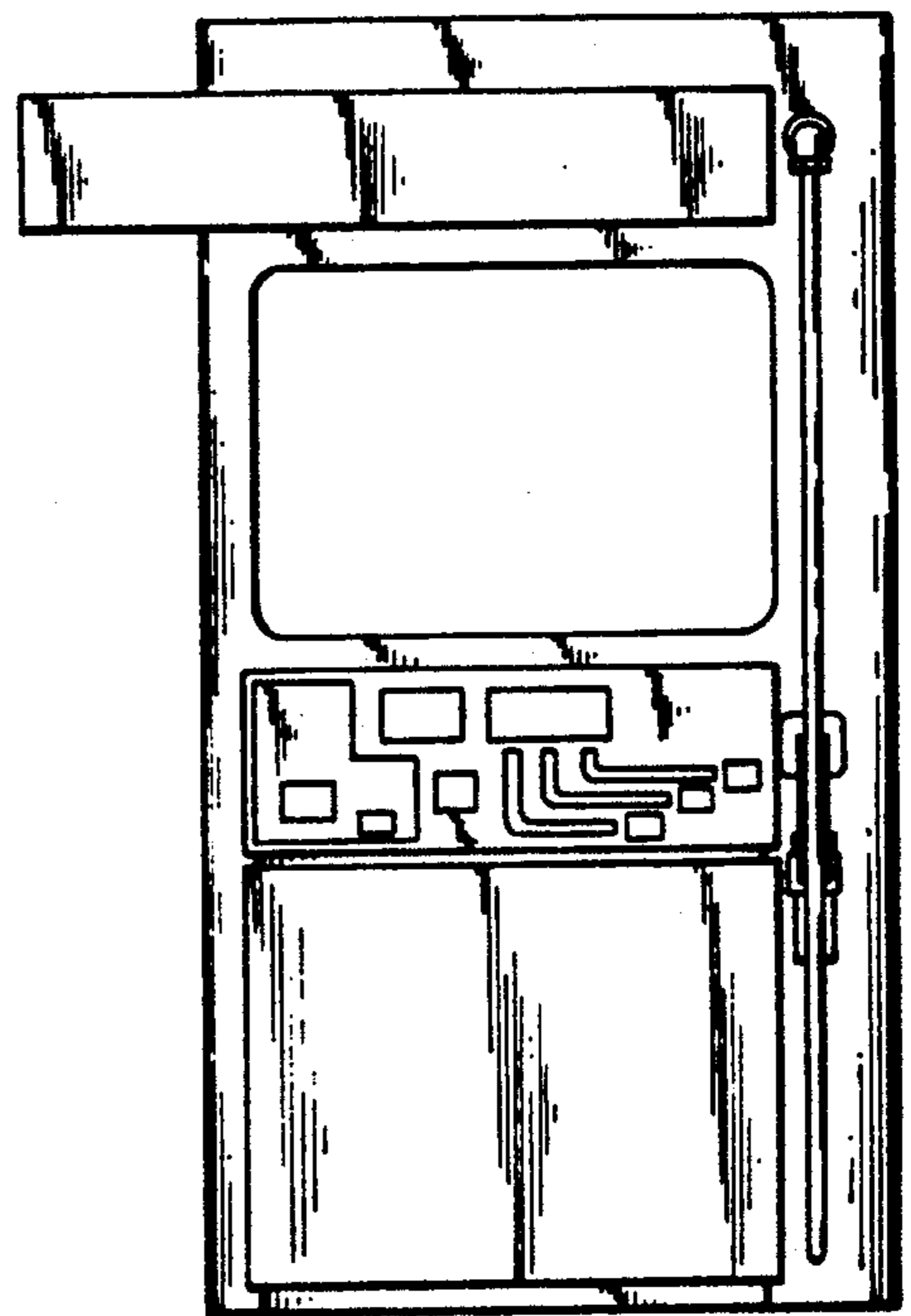

FIG. 9

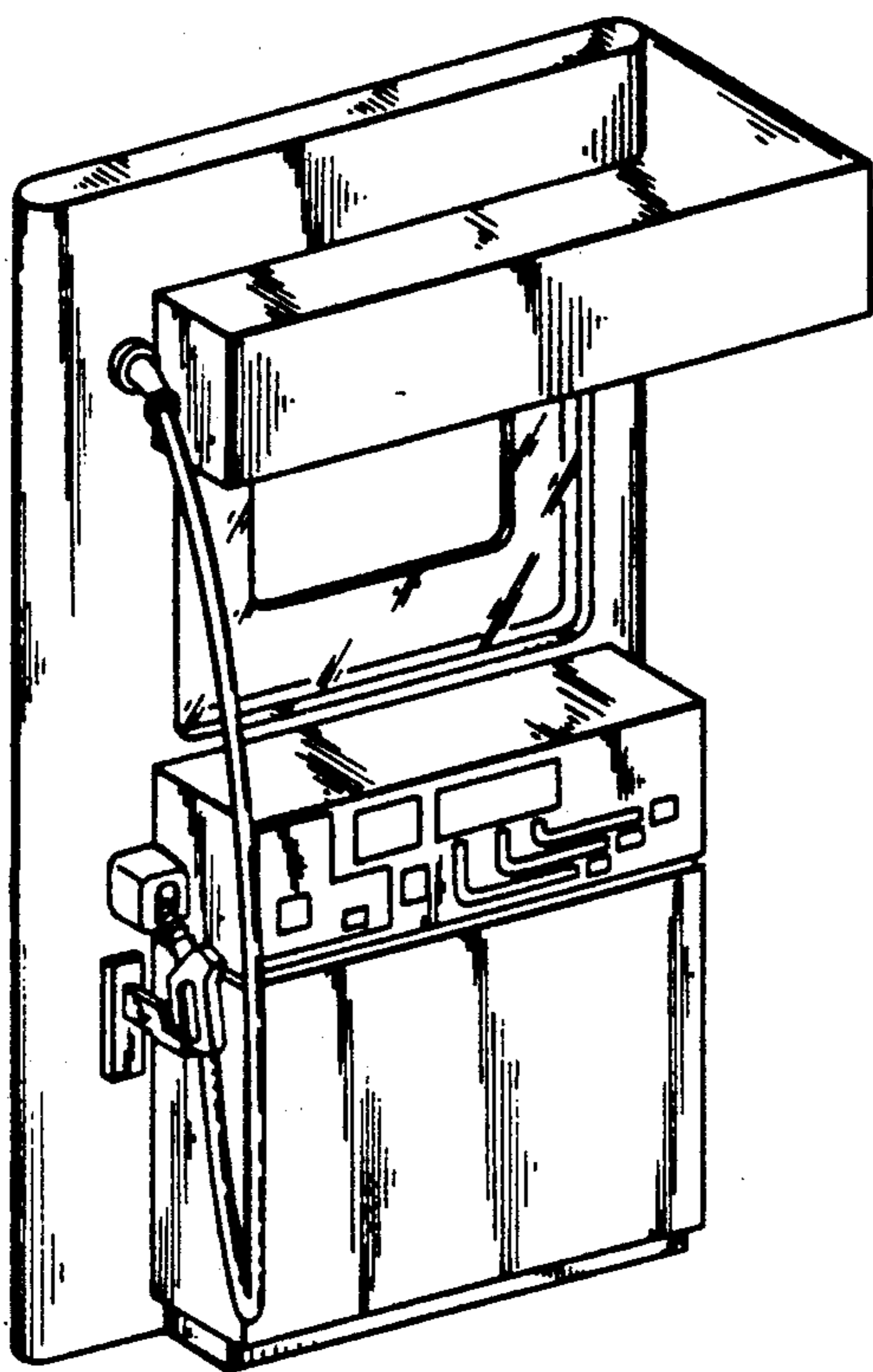

FIG. 10

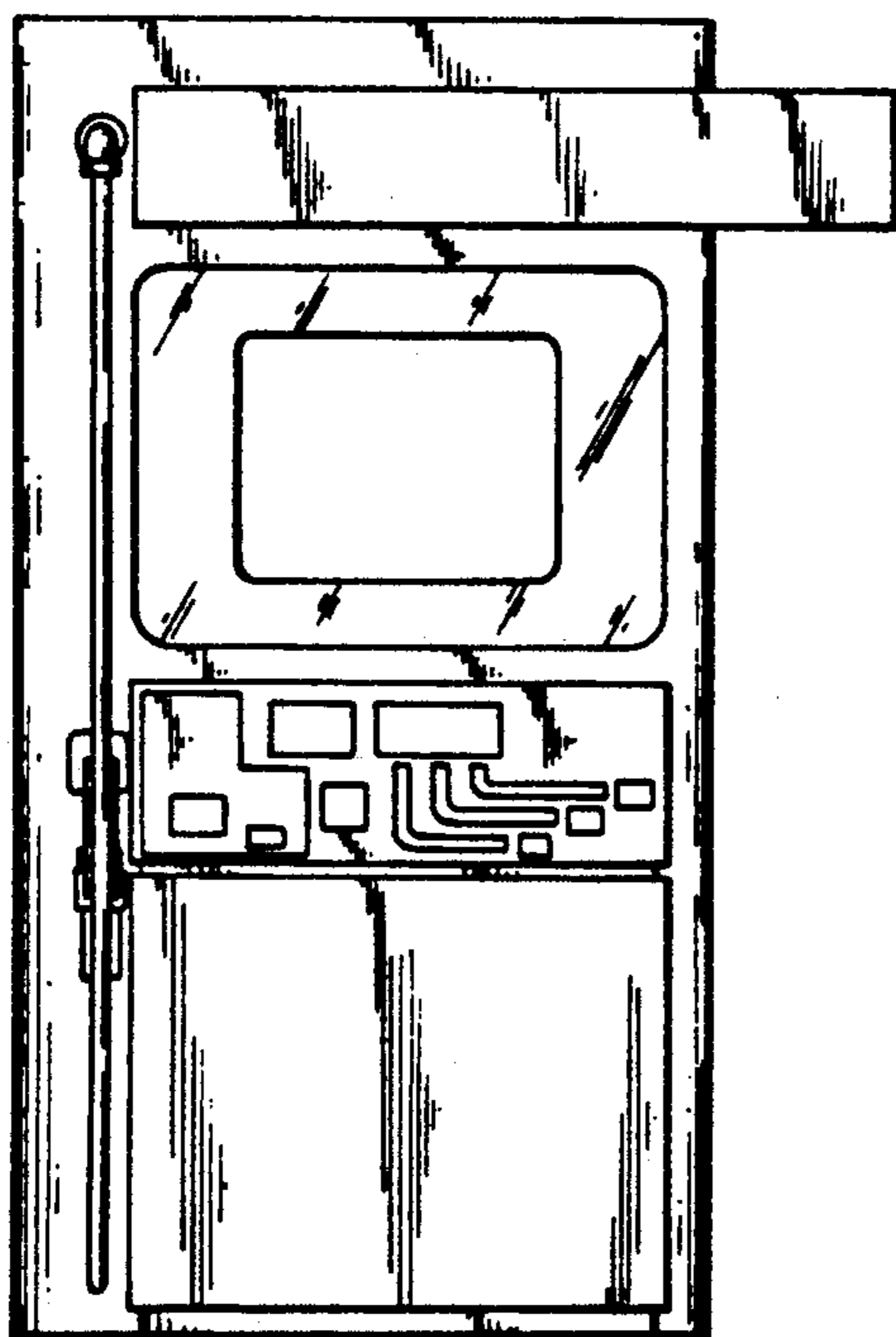

FIG. 11

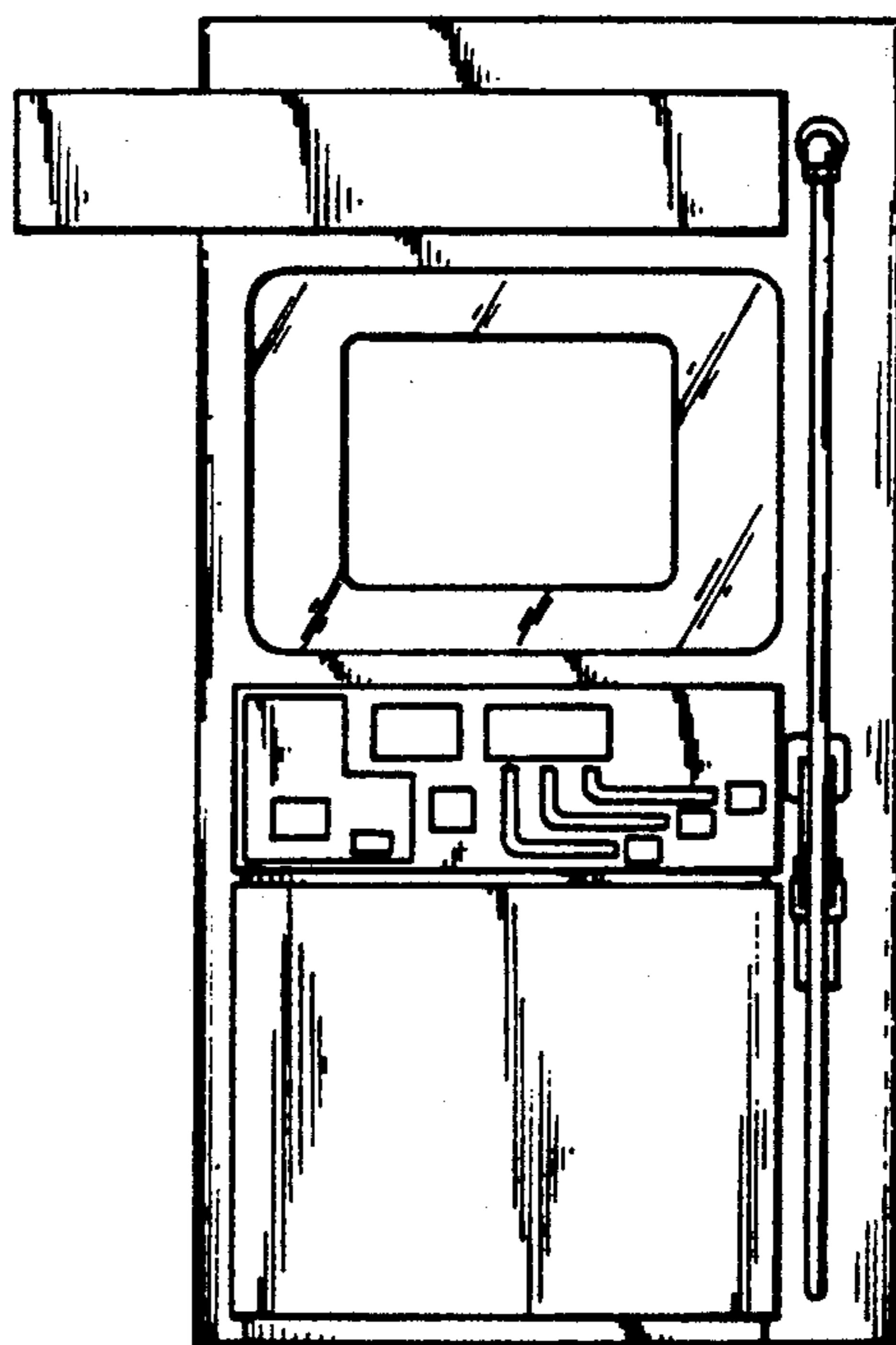

FIG. 12

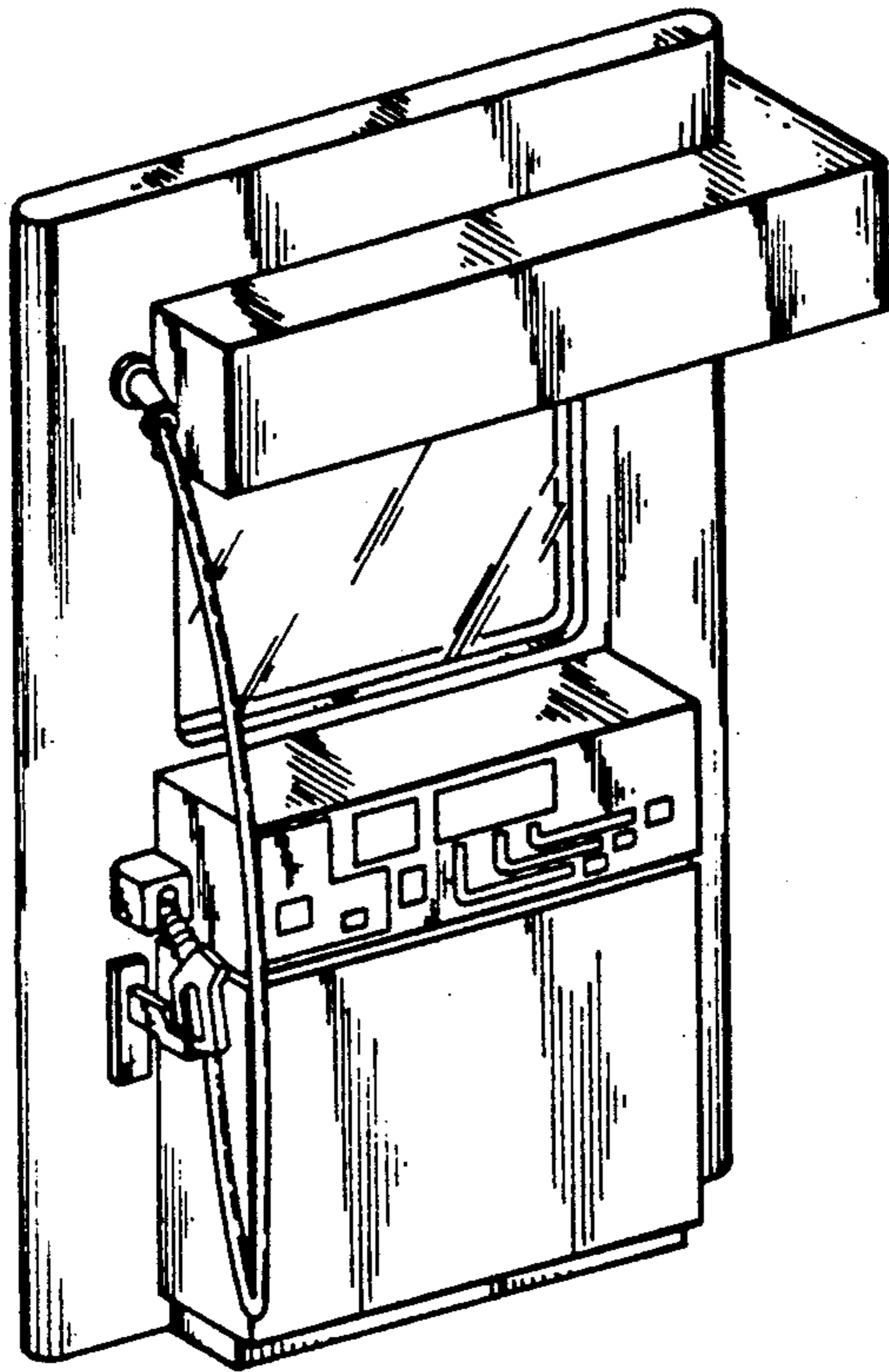

FIG. 13

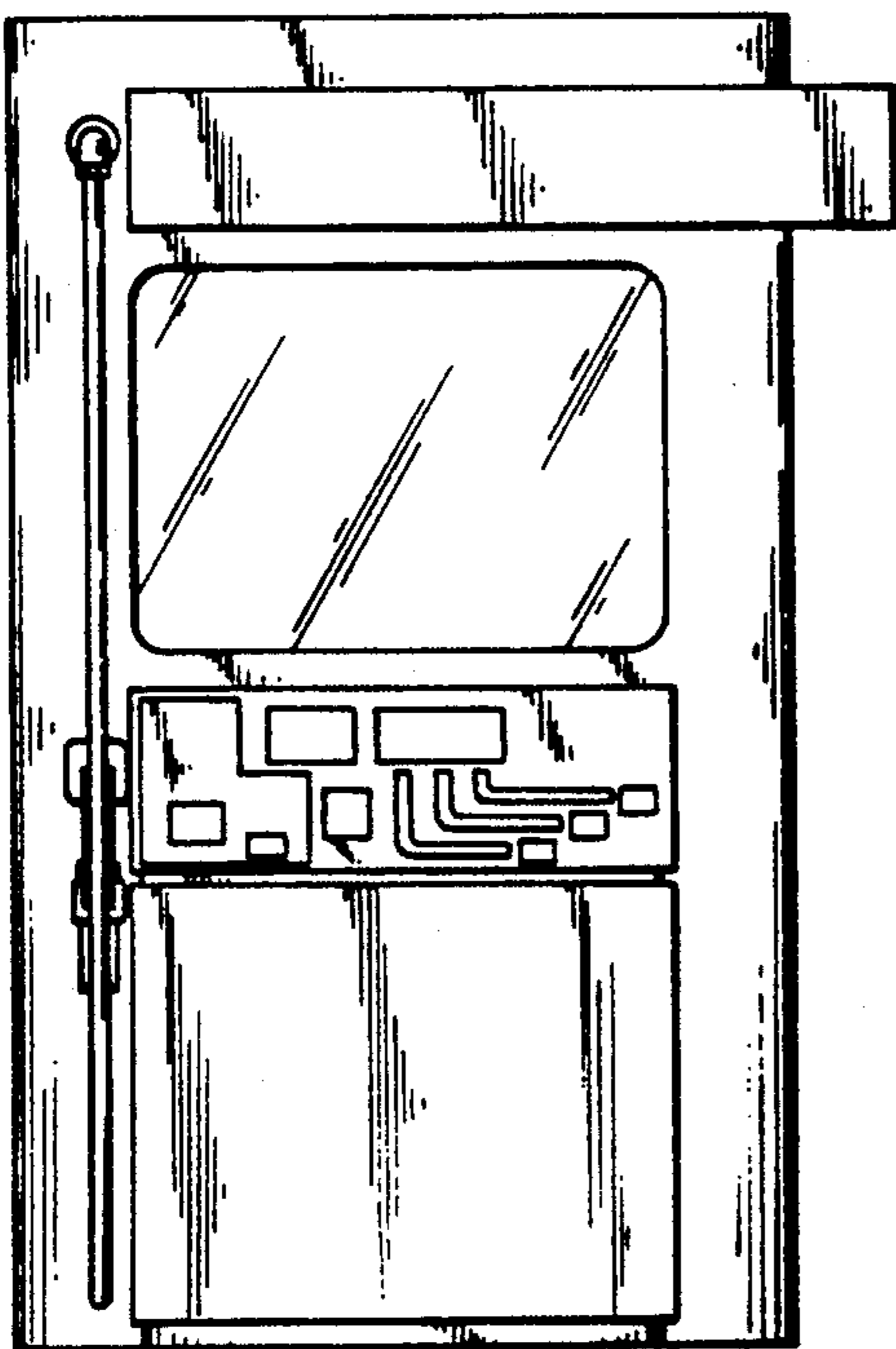

FIG. 14

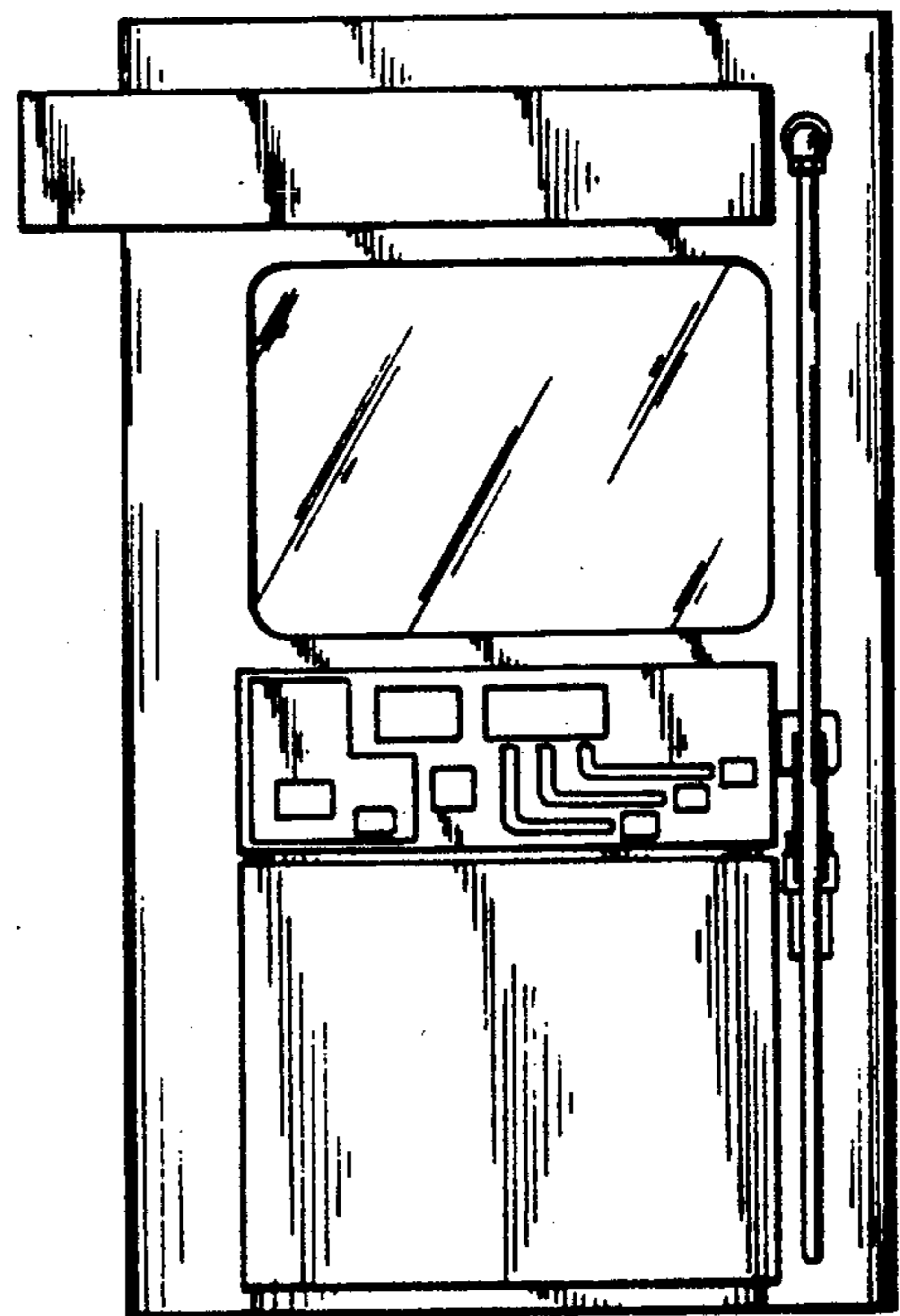

FIG. 15

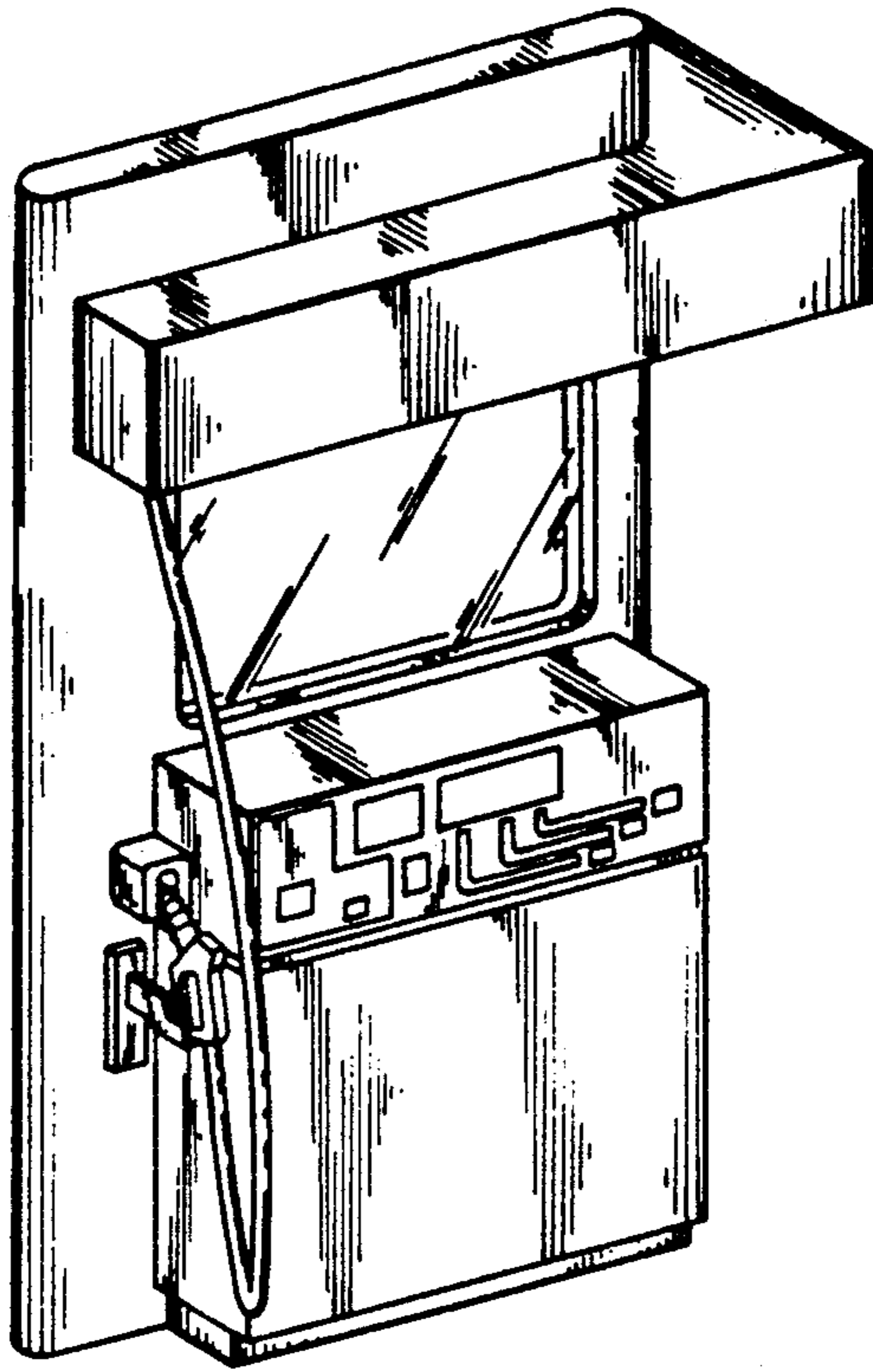

FIG. 16

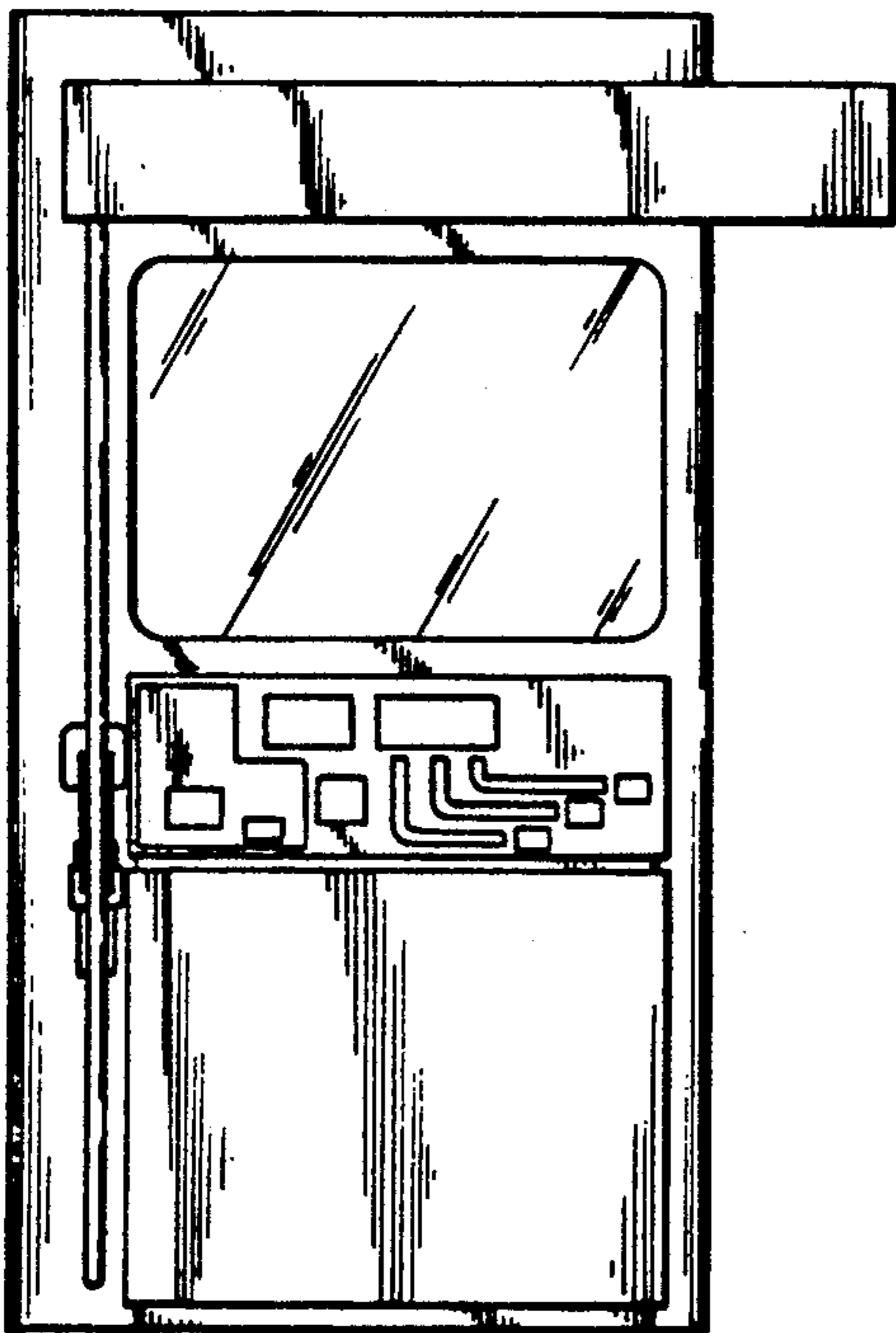

FIG. 17

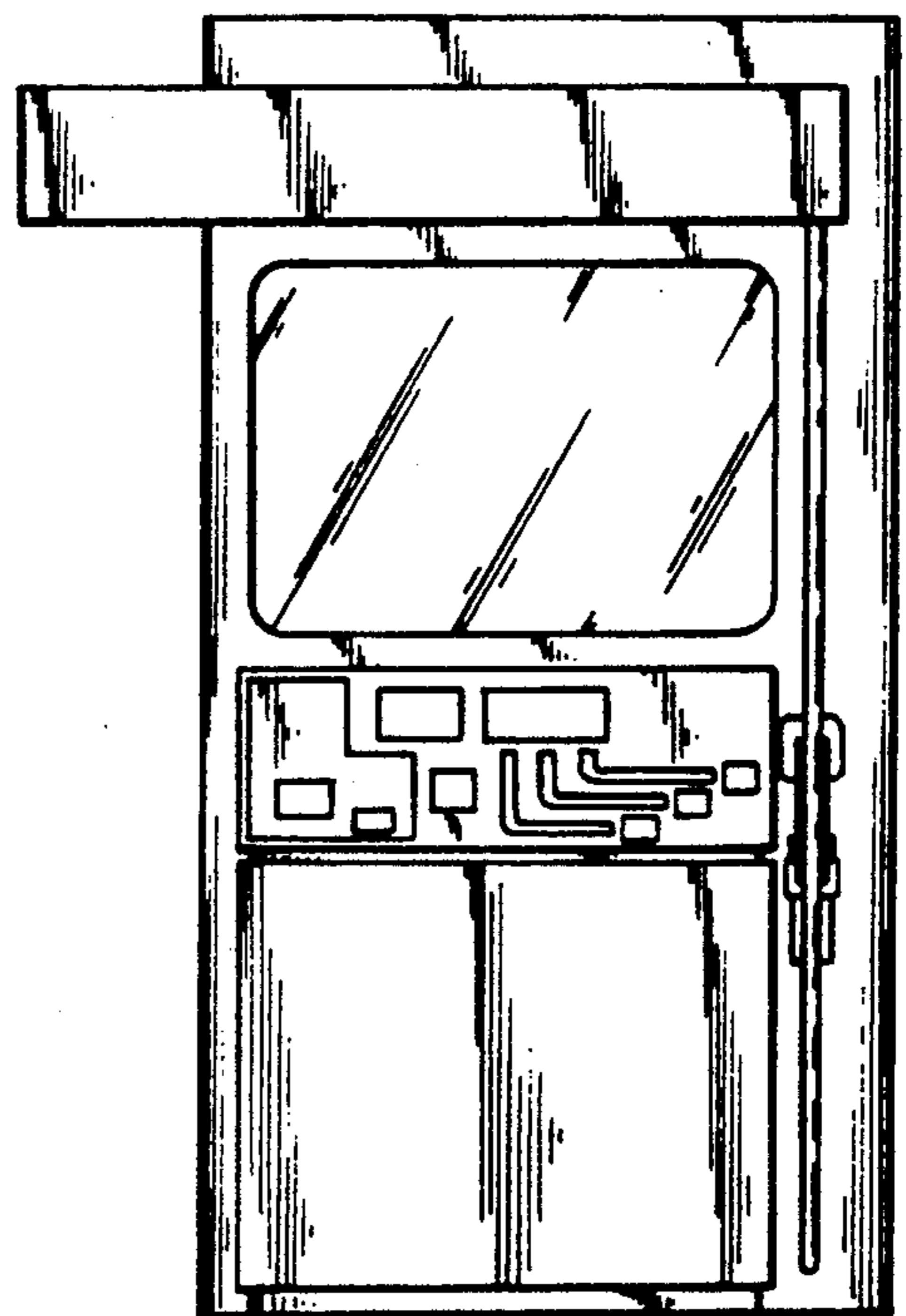

FIG. 18

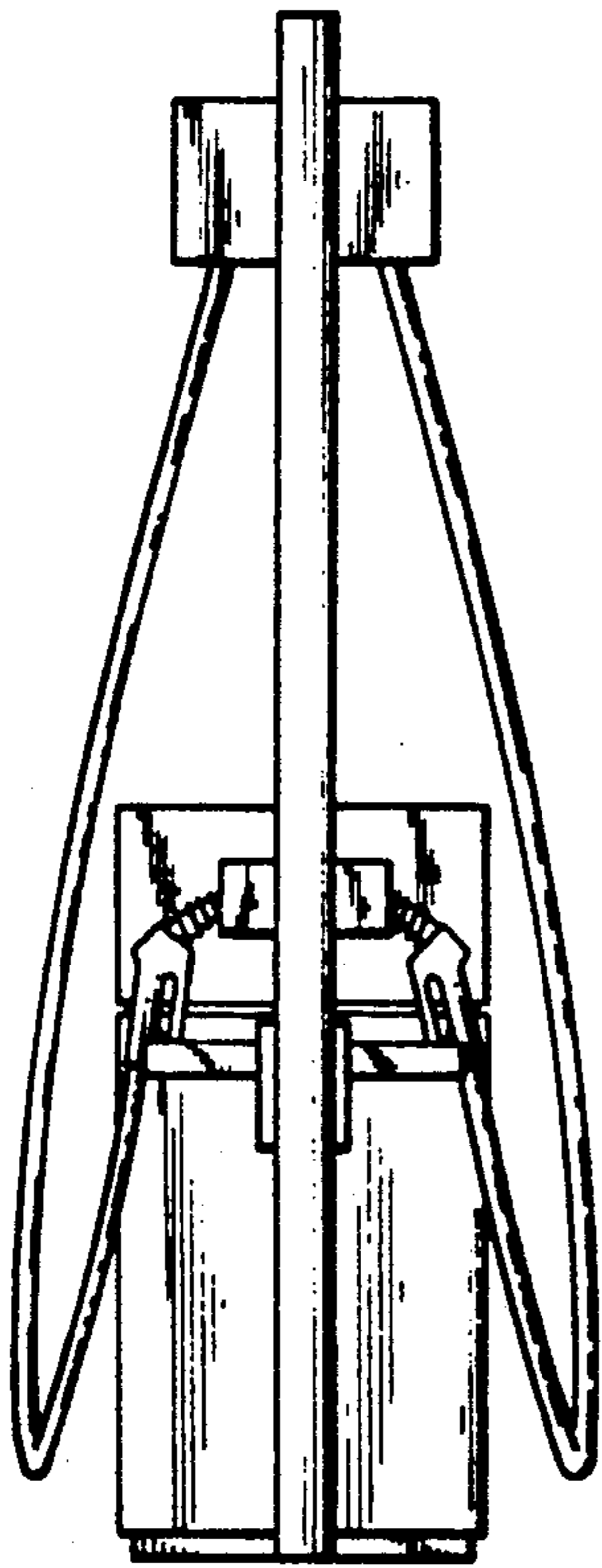

FIG. 19

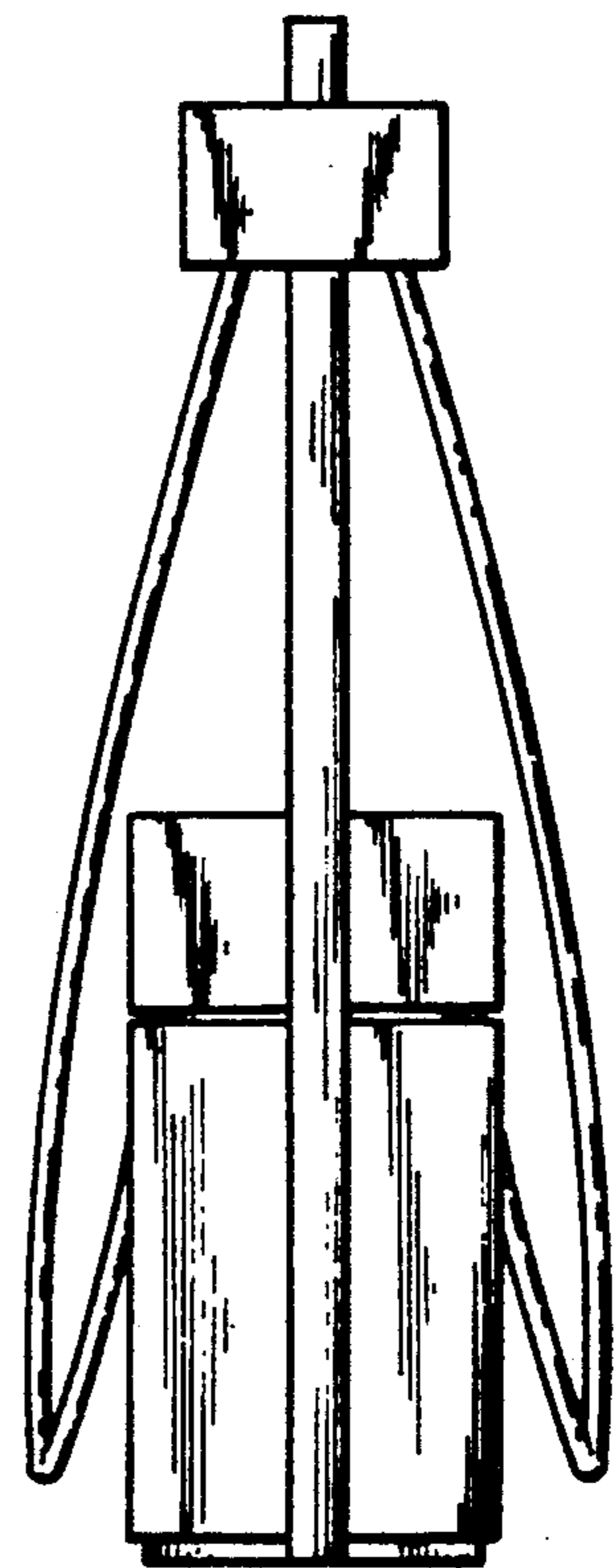

FIG. 20