



US00D335609S

United States Patent [19]

[11] Patent Number: **Des. 335,609**

Cesaroni et al.

[45] Date of Patent: **** May 18, 1993**

[54] **VEGETABLE CUTTER**

[57] **CLAIM**

[75] Inventors: **William C. Cesaroni**, Glenview, Ill.;
David C. Belongia, West Bend, Wis.

The ornamental design for a vegetable cutter, as shown and described.

[73] Assignee: **The West Bend Company**, West Bend, Wis.

DESCRIPTION

[**] Term: **14 Years**

FIG. 1 is a perspective view of our vegetable cutter showing our new design;

[21] Appl. No.: **736,891**

FIG. 2 is a front view thereof;

[22] Filed: **Jul. 26, 1991**

FIG. 3 is a rear view thereof;

[52] U.S. Cl. **D7/381**

FIG. 4 is a side view thereof;

[58] Field of Search **D7/381-385,**
D7/693; 99/538; 241/169, 169.1

FIG. 5 is a view of the opposite side thereof;

FIG. 6 is a top plan view thereof;

FIG. 7 is a bottom plan view thereof;

FIG. 8 is a perspective view thereof shown in a stored position with the components nested;

FIG. 9 is a front view of FIG. 8;

FIG. 10 is a rear view of FIG. 8;

FIG. 11 is a side view of FIG. 8;

FIG. 12 is a view from the opposite side of FIG. 8;

FIG. 13 is a top plan view of FIG. 8; and,

FIG. 14 is a bottom plan view of FIG. 8.

[56] **References Cited**

U.S. PATENT DOCUMENTS

D. 244,416 5/1977 Zysset **D7/693**

D. 303,482 9/1989 Barrault **D7/381**

Primary Examiner—Terry A. Pfeffer

Attorney, Agent, or Firm—Russell L. McIlwain

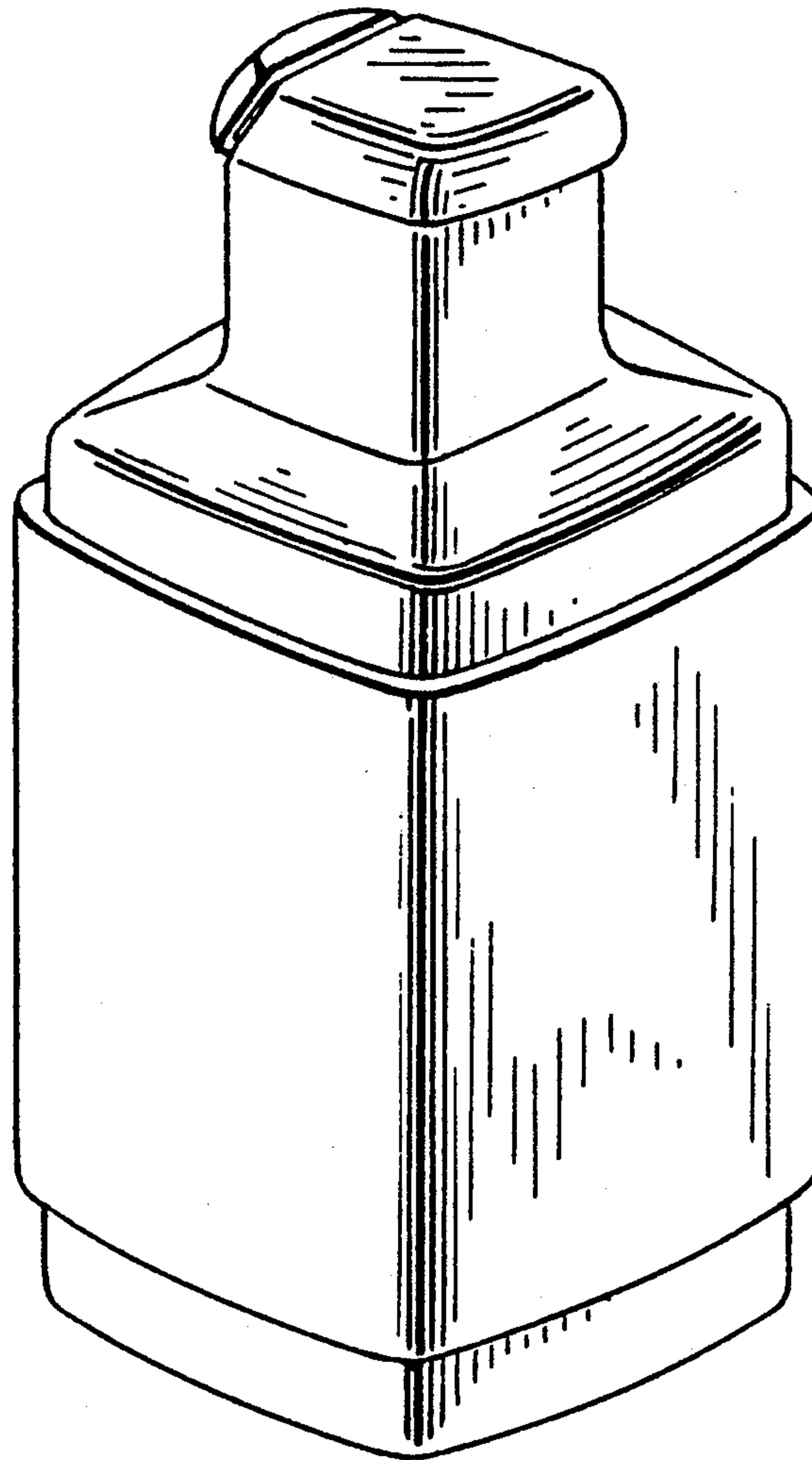

FIG. 1

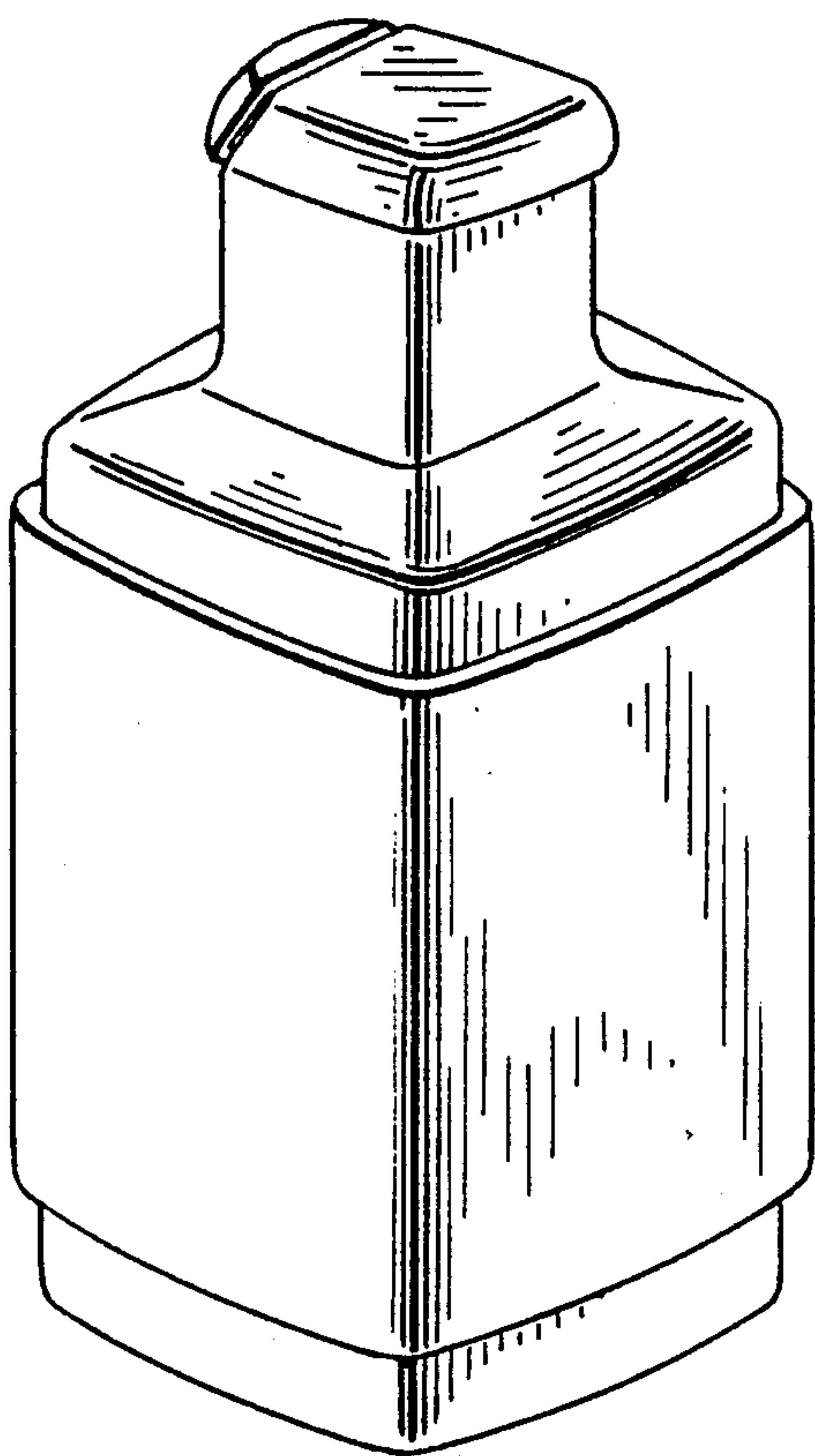

FIG. 6

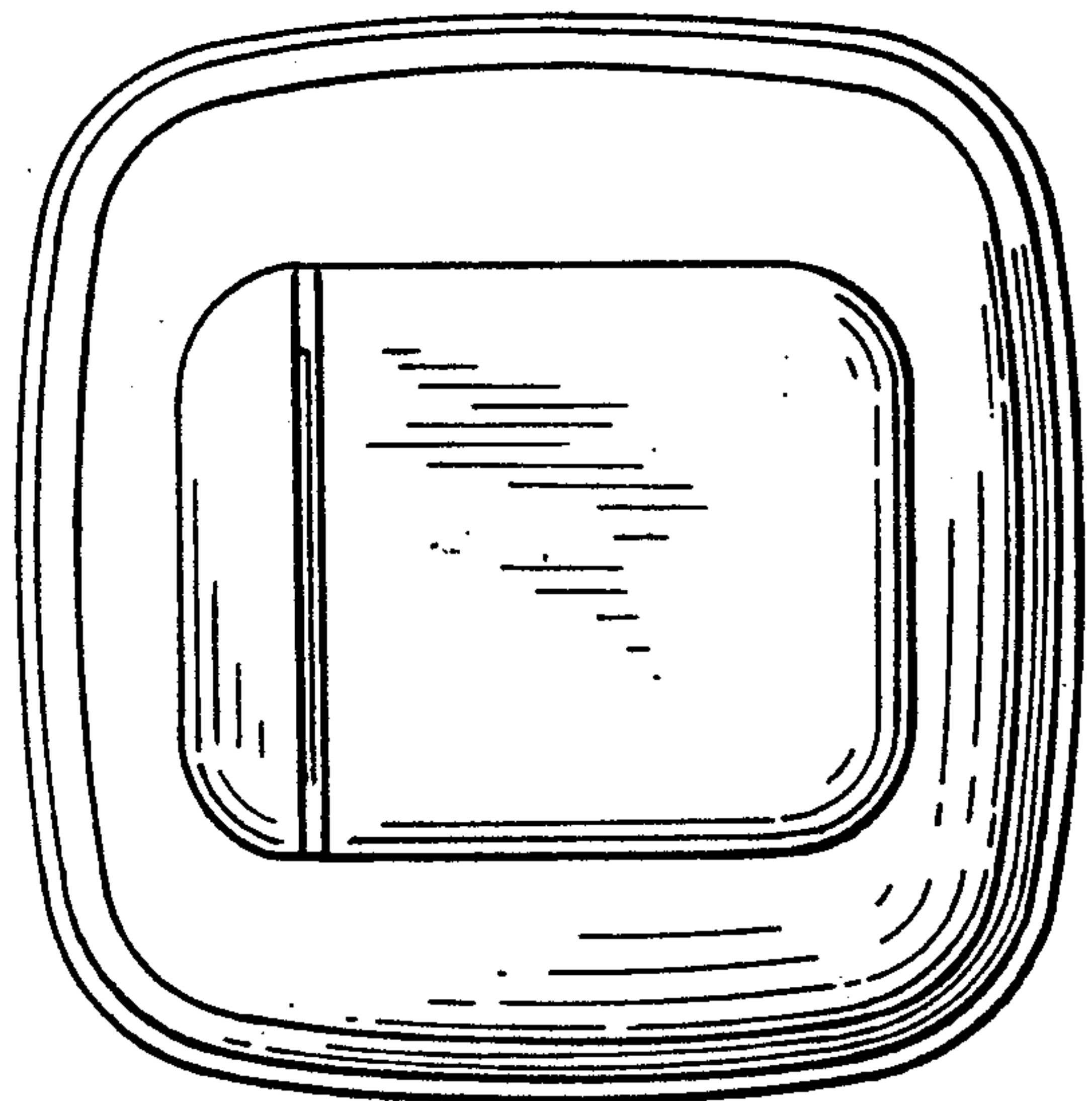

FIG. 7

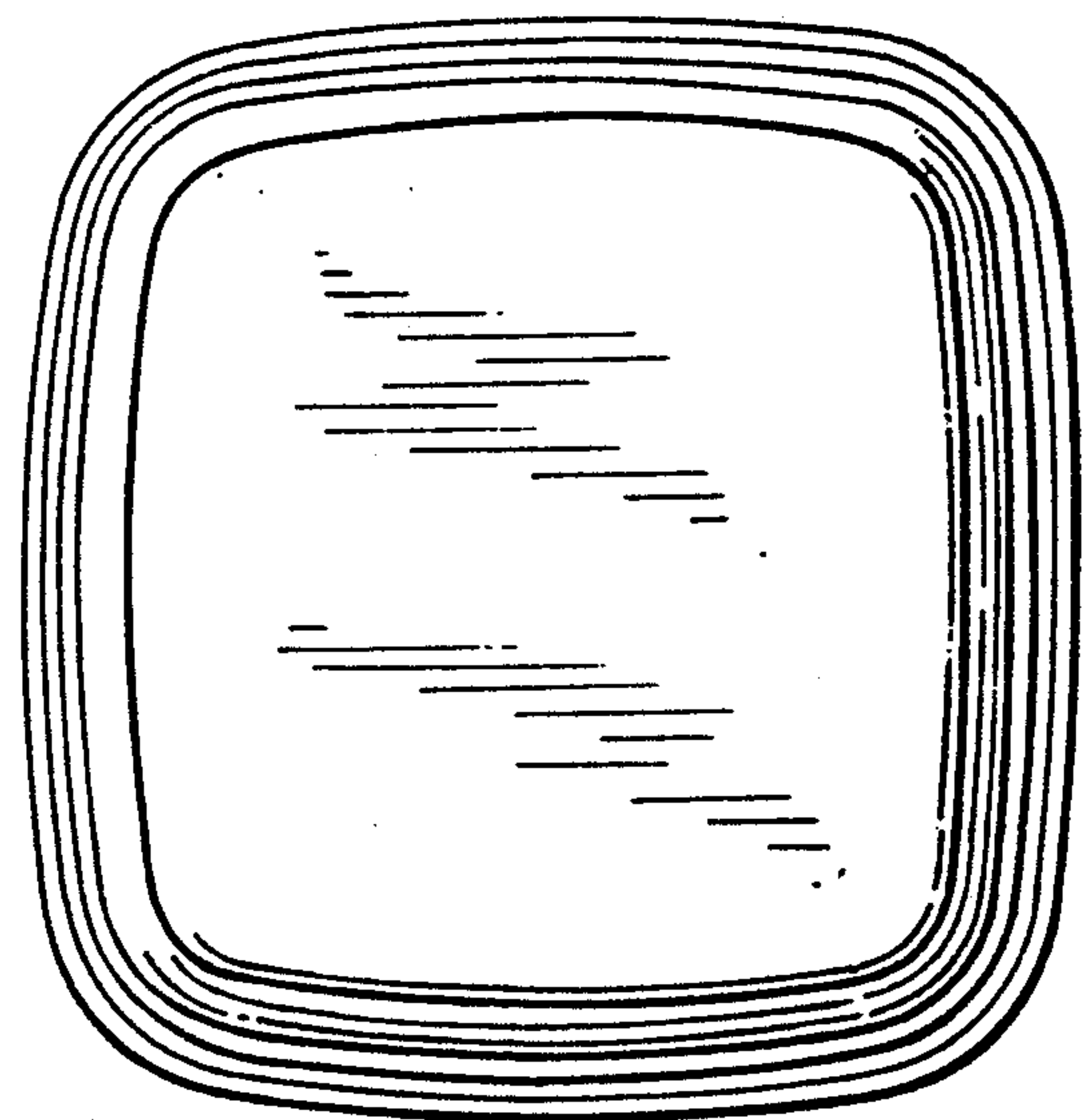

FIG. 2

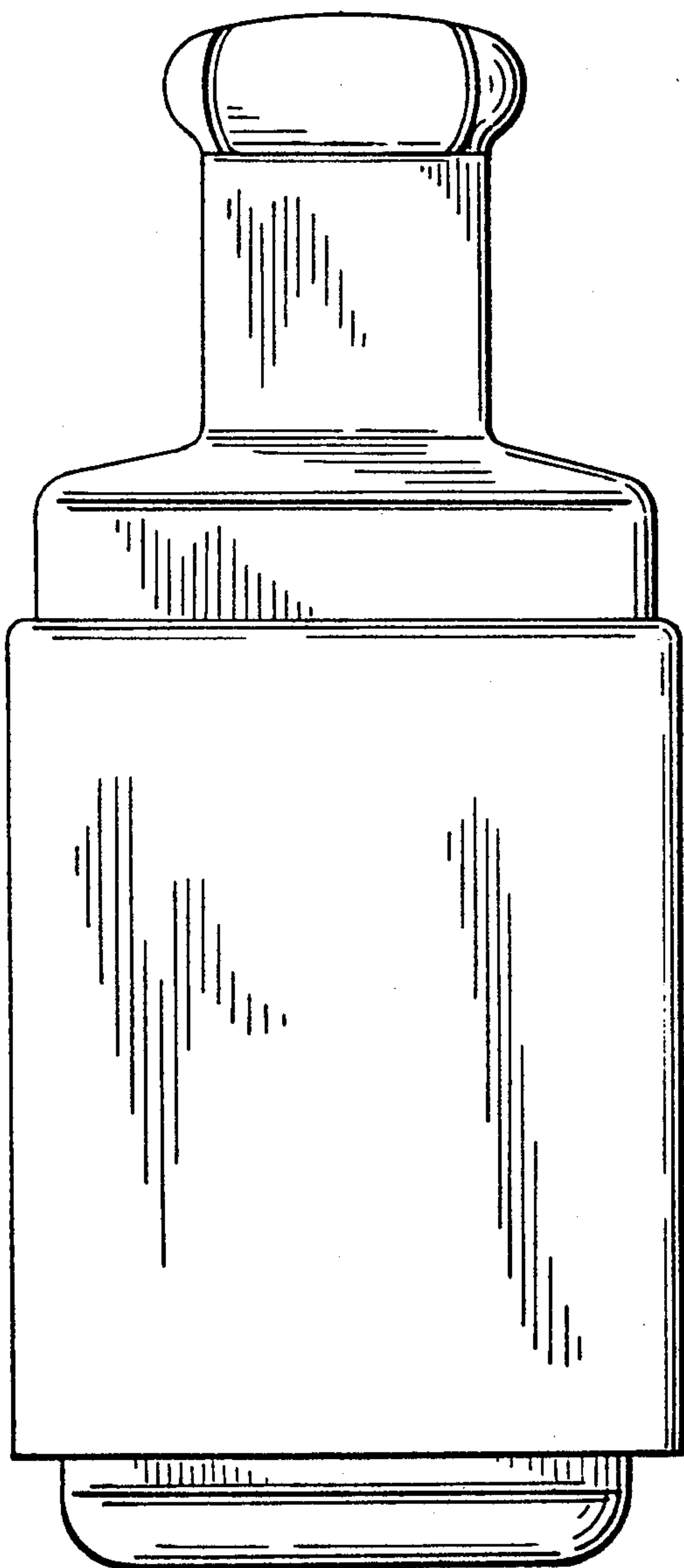

FIG. 3

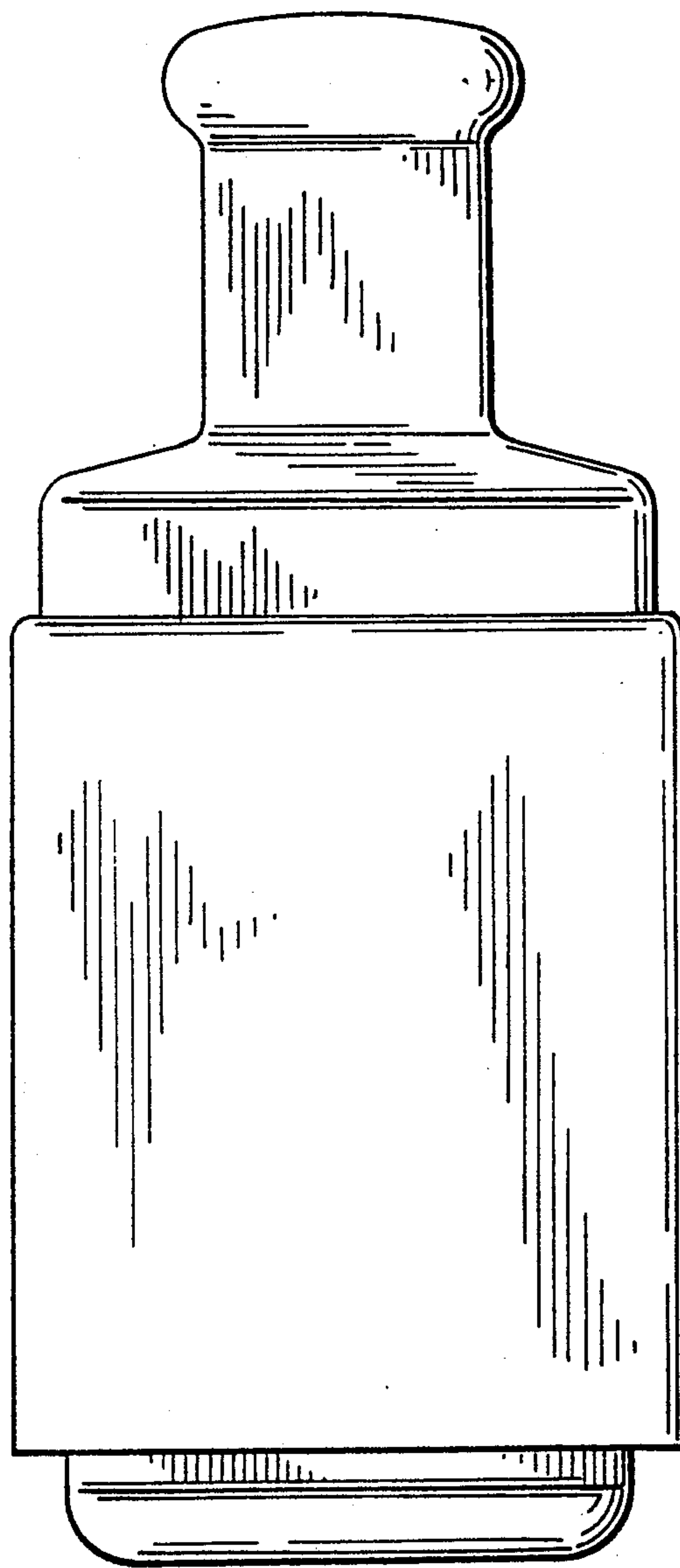

FIG. 4

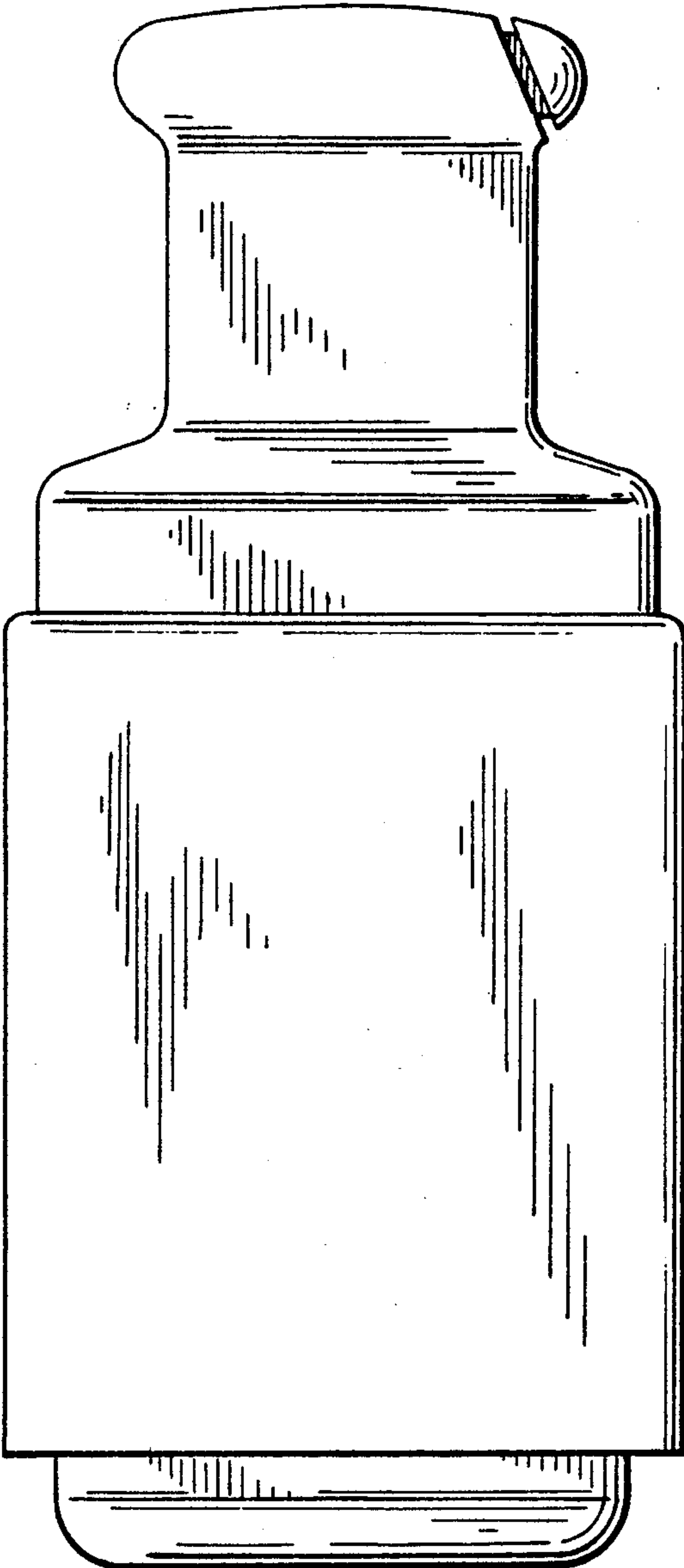

FIG. 5

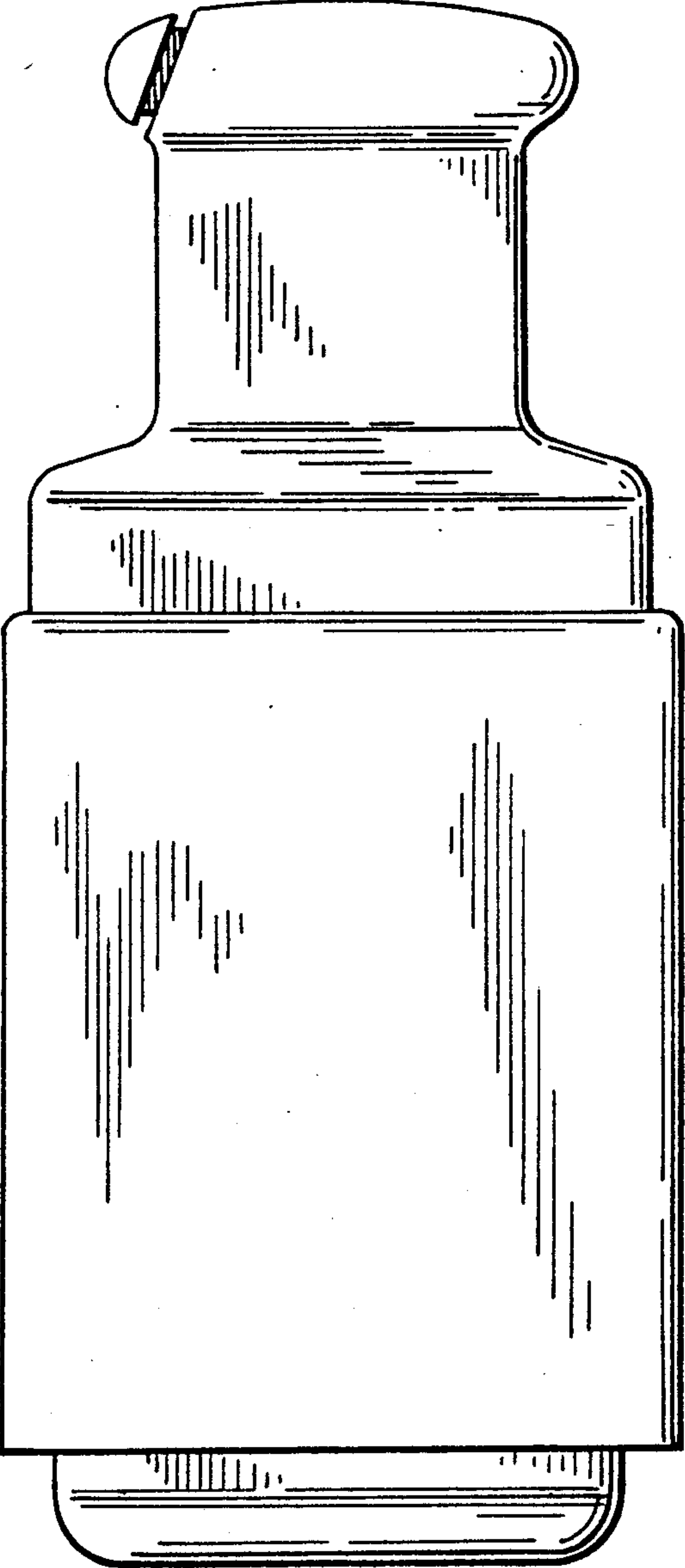

FIG. 8

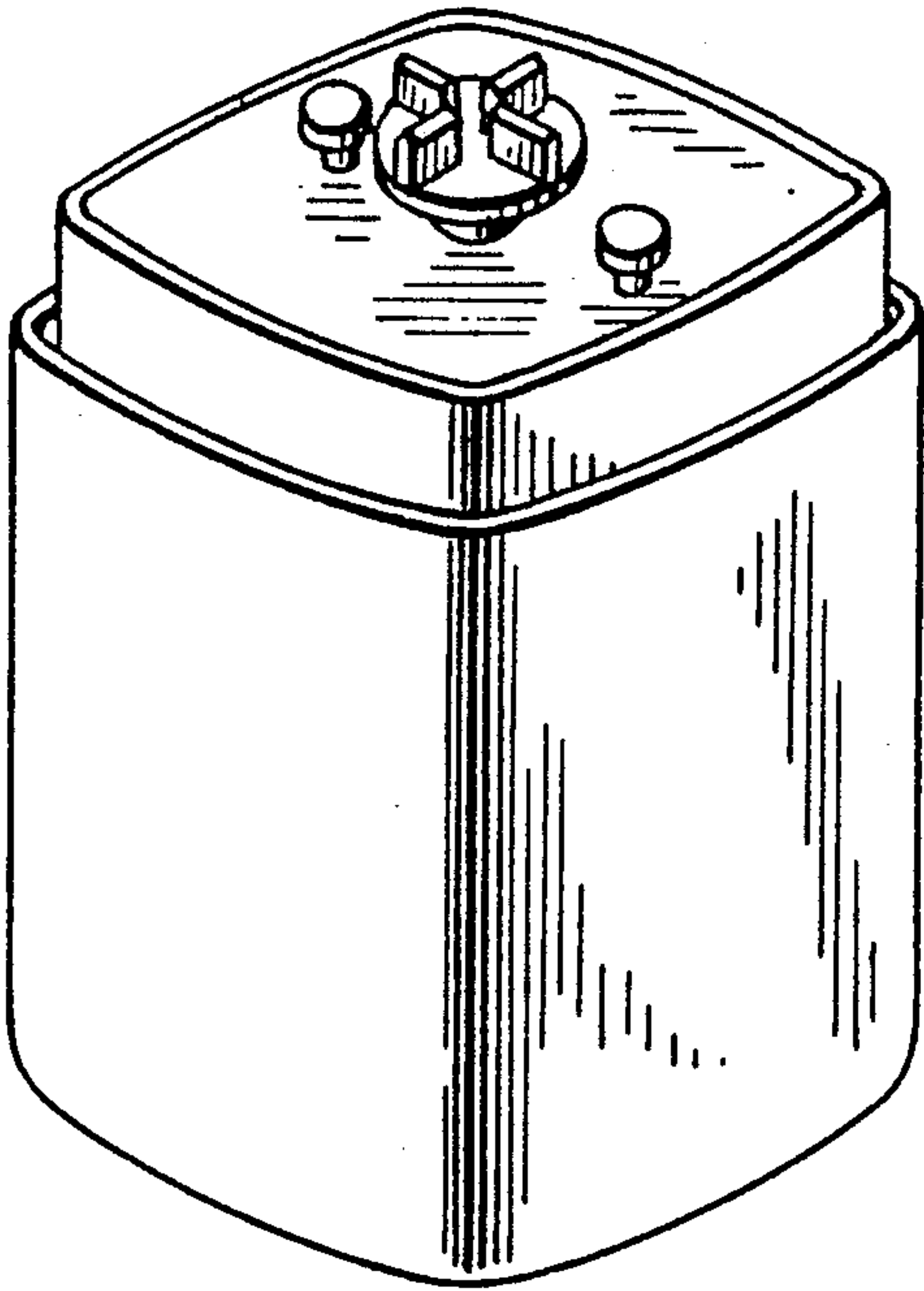

FIG. 13

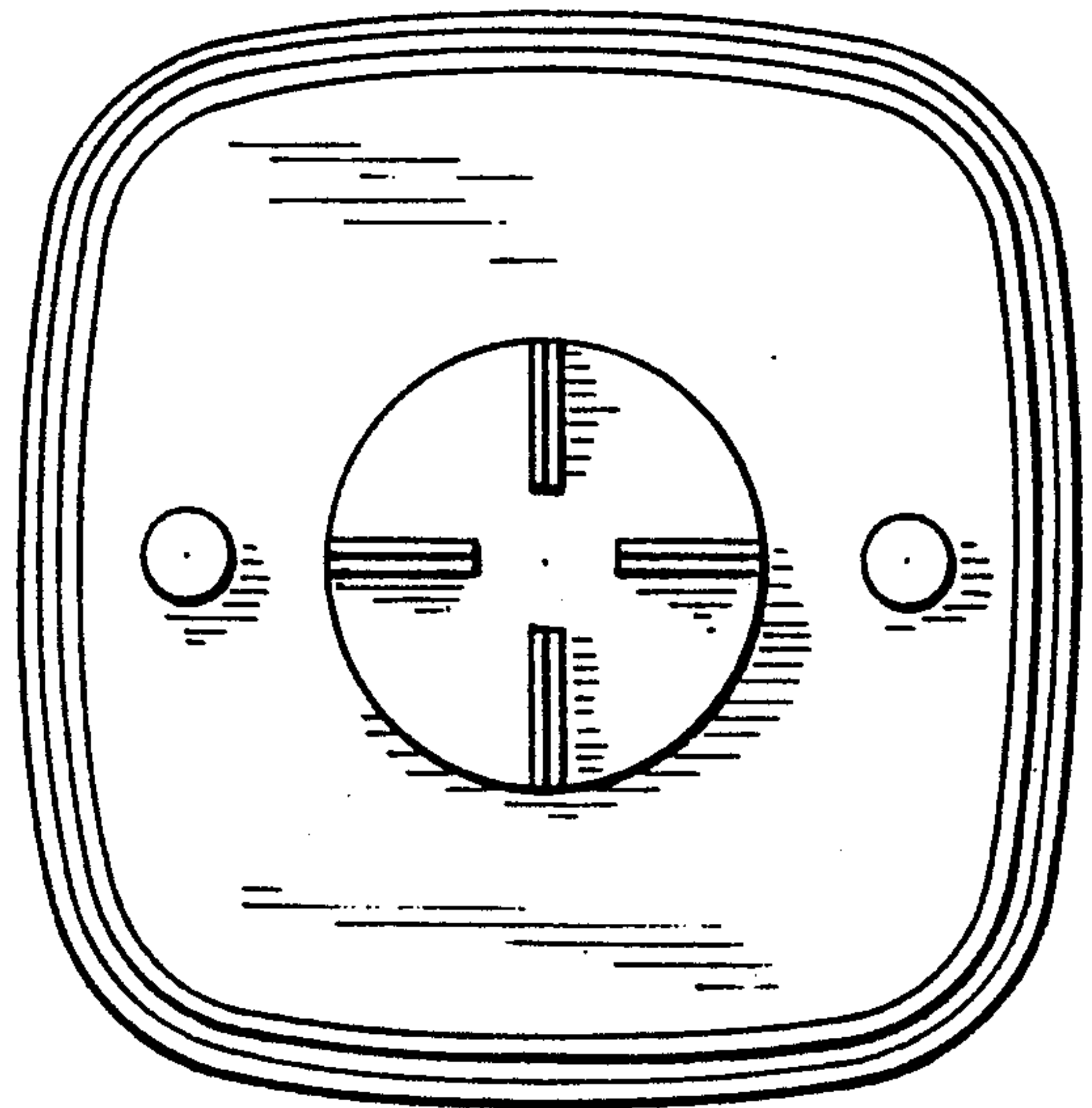

FIG. 14

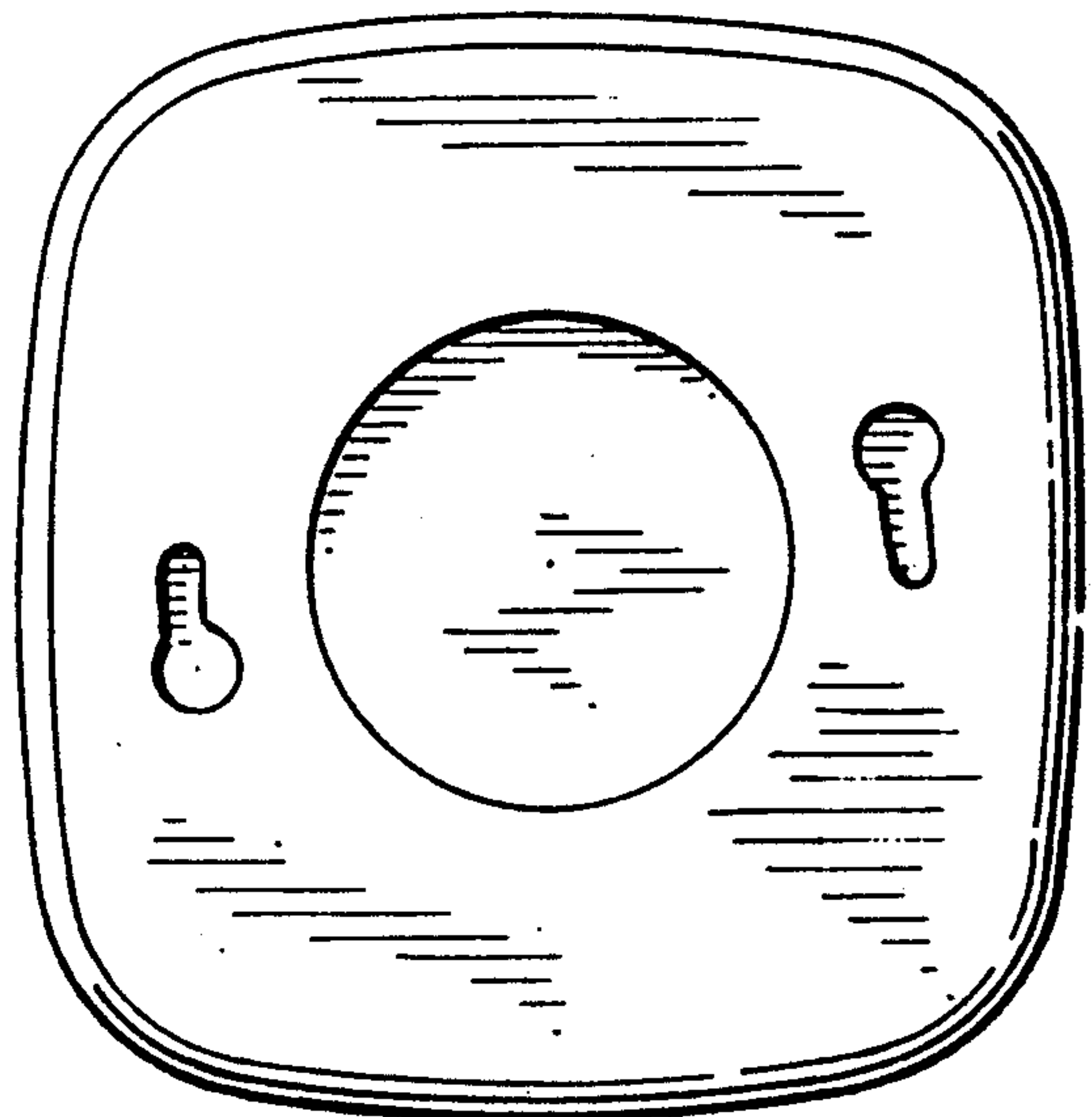

FIG. 9

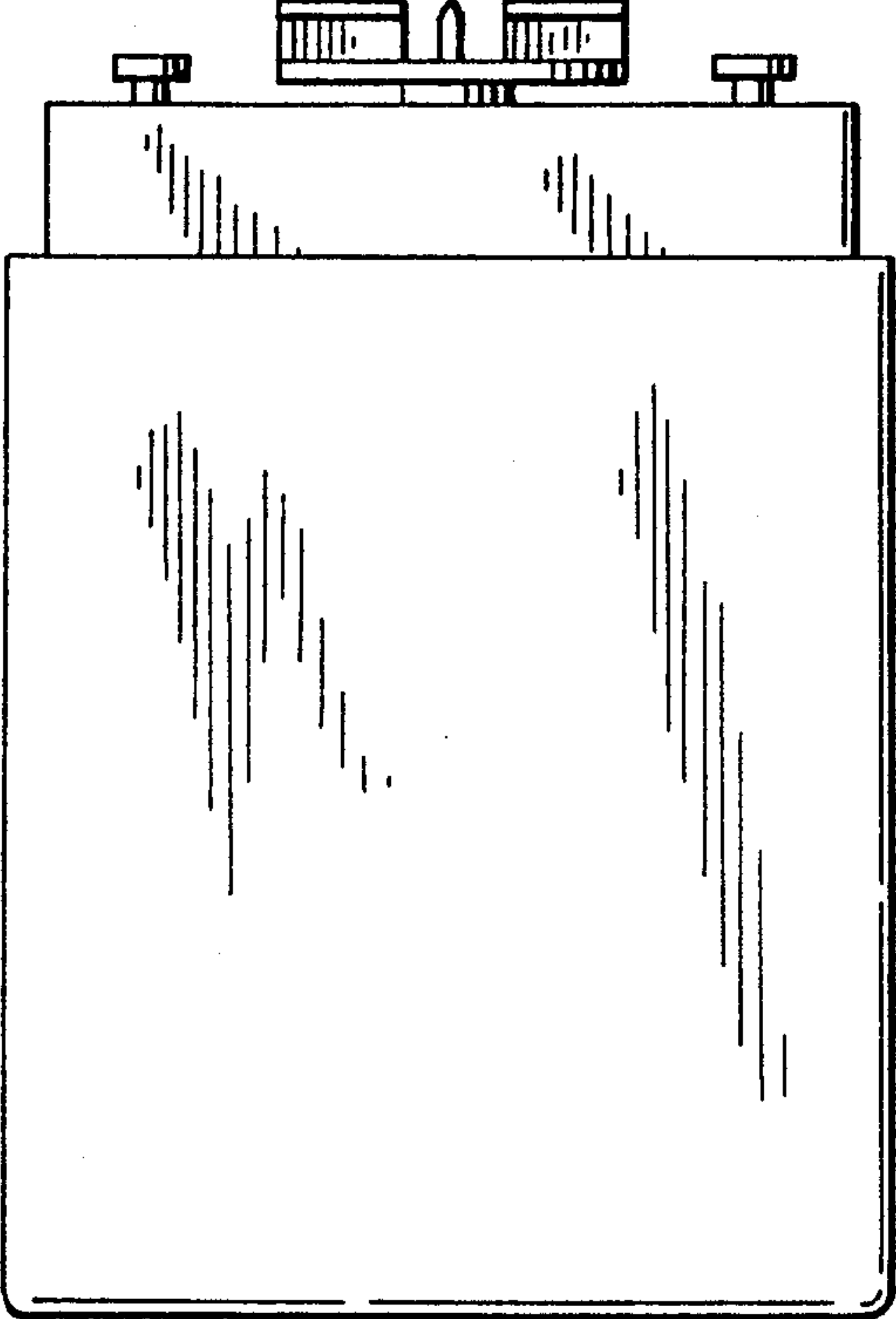

FIG. 11

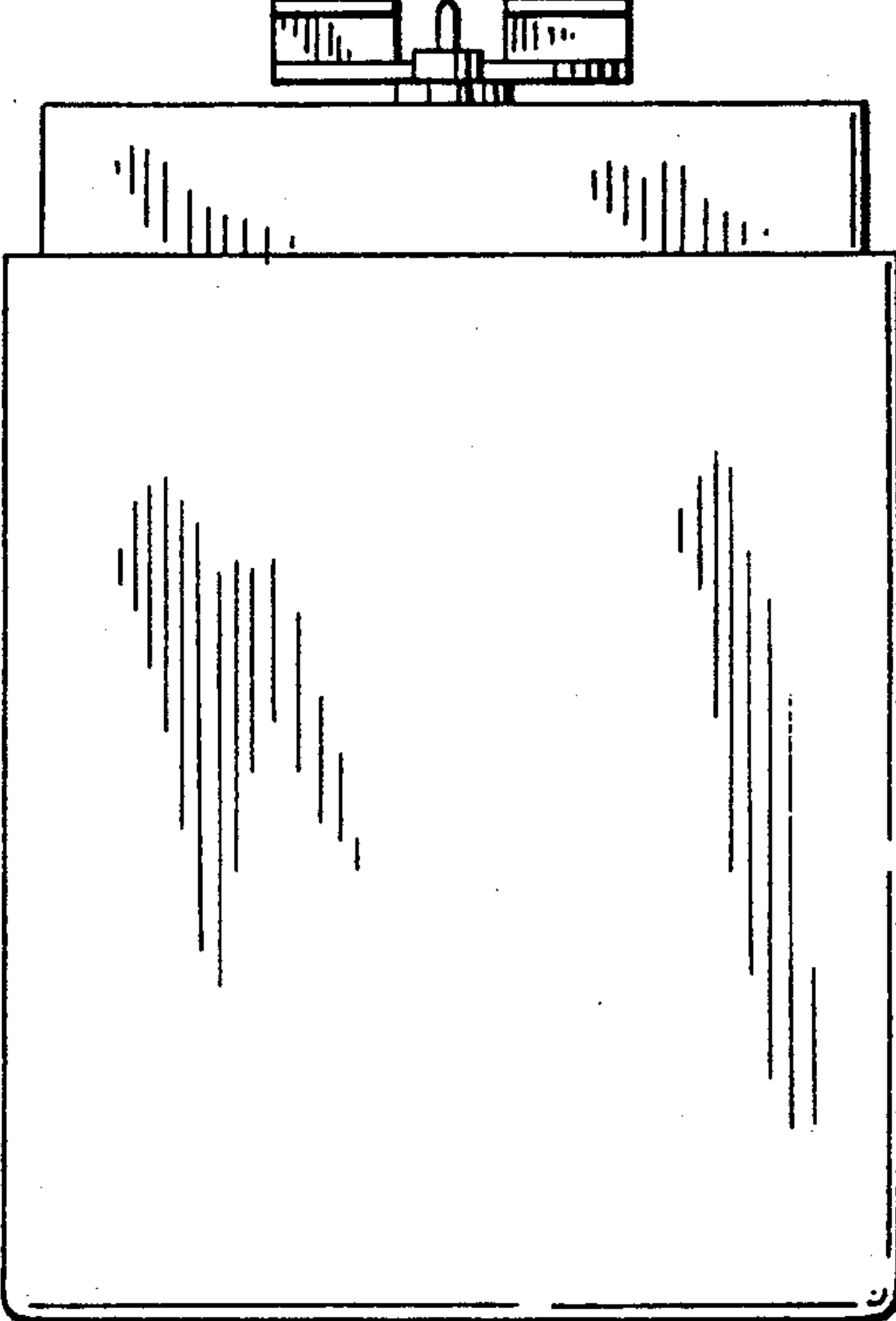

FIG. 10

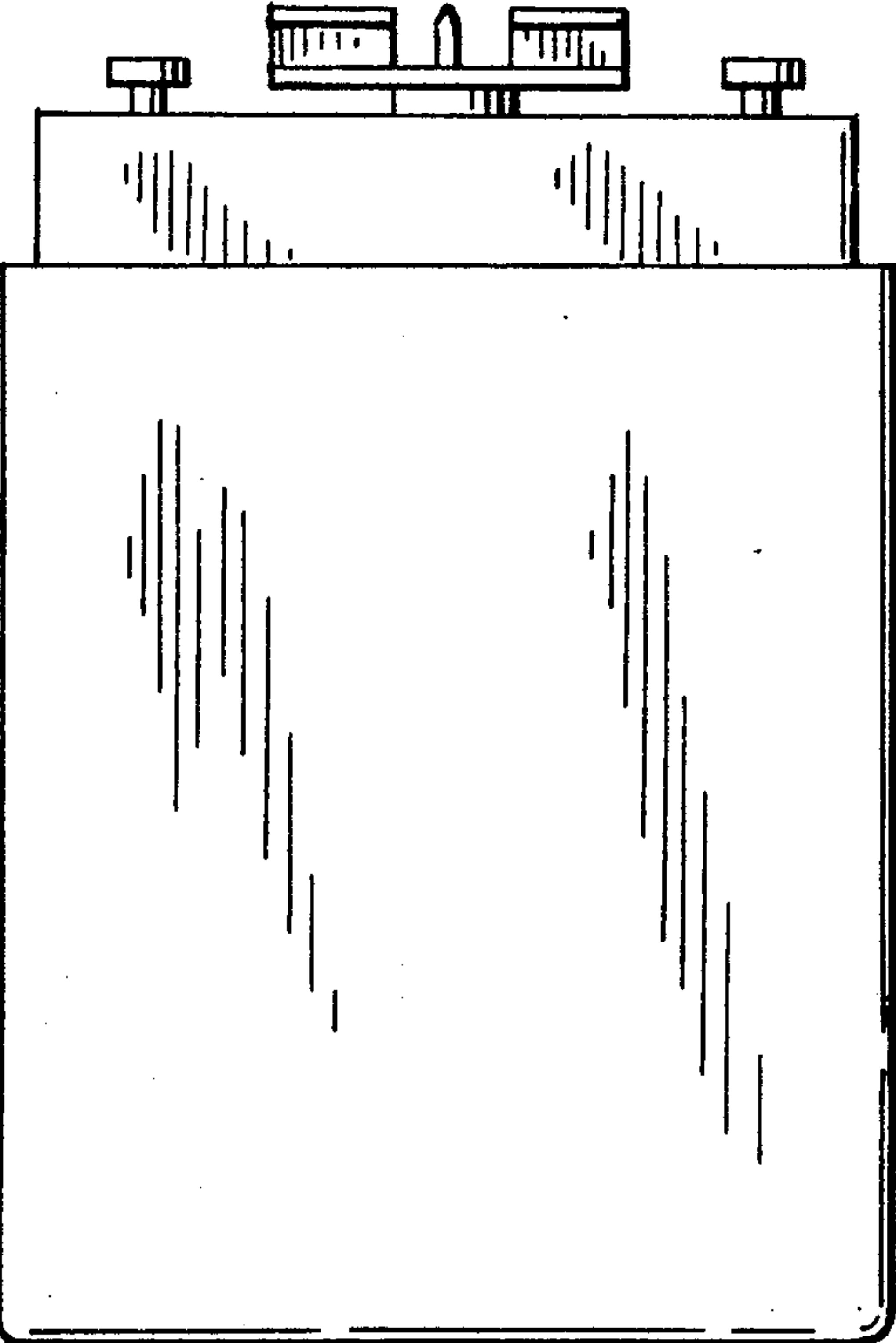

FIG. 12

