



- US00D335596S

# United States Patent [19]

[11] Patent Number: **Des. 335,596**

Wogoman et al.

[45] Date of Patent: **\*\* May 18, 1993**

## [54] OFFICE CHAIR

[75] Inventors: **Steven S. Wogoman, Elkhart, Ind.;**  
**Robert G. Martinez, Akron, Ohio**

[73] Assignee: **Harter Corporation, Sturgis, Mich.**

[\*\*] Term: **14 Years**

[21] Appl. No.: **853,155**

[22] Filed: **Mar. 18, 1992**

### Related U.S. Application Data

[62] Division of Ser. No. 364,184, Jun. 9, 1989.

[52] U.S. Cl. .... **D6/500**

[58] Field of Search ..... **D6/365, 366, 500, 358,**  
**D6/364; 297/DIG. 2, 411, 412, 421**

### [56] References Cited

#### U.S. PATENT DOCUMENTS

D. 274,675	7/1984	Diffrient	.....	D6/366
D. 277,143	1/1985	Helmholdt	.....	D6/366
D. 279,332	6/1985	Diffrient	.....	D6/364 X
D. 292,655	11/1987	Hendrick	.....	D6/366
D. 306,531	3/1990	Snodgrass	.....	D6/366
D. 309,385	7/1990	Buhk	.....	D6/501 X
699,428	5/1902	Truslow	.....	297/421 X
1,192,941	8/1916	Schmid	.....	297/421
1,555,396	9/1925	Bourgon	.....	297/412 X
1,814,276	9/1929	Anoskopay	.....	297/DIG. 2 X
5,114,212	5/1992	Verney et al.	.....	297/421

## FOREIGN PATENT DOCUMENTS

59824 9/1982 European Pat. Off. .... 297/412

## OTHER PUBLICATIONS

*Interiors*, May 1982, p. 143, "Como Swivel Chair", center of page.

*Interiors*, Aug. 1986, p. 76, "Bühk 100" Chair, center of page.

*Interiors*, Feb. 1983, p. 26, Anthropom Chair, center of page.

*Primary Examiner*—Alan P. Douglas

*Assistant Examiner*—Monica A. Hannon

*Attorney, Agent, or Firm*—Renner, Kenner, Greive, Bobak, Taylor & Weber

## [57] CLAIM

The ornamental design for an office chair, as shown and described.

## DESCRIPTION

FIG. 1 is a perspective view of an office chair showing our new design, the broken lines are for environmental purposes only and form no part of the claimed design; FIG. 2 is a right side elevational view of an office chair, the left side being a mirror image, showing our new design;

FIG. 3 is a front perspective view thereof;

FIG. 4 is a top perspective view thereof;

FIG. 5 is a rear perspective view thereof; and,

FIG. 6 is a bottom plan view thereof.

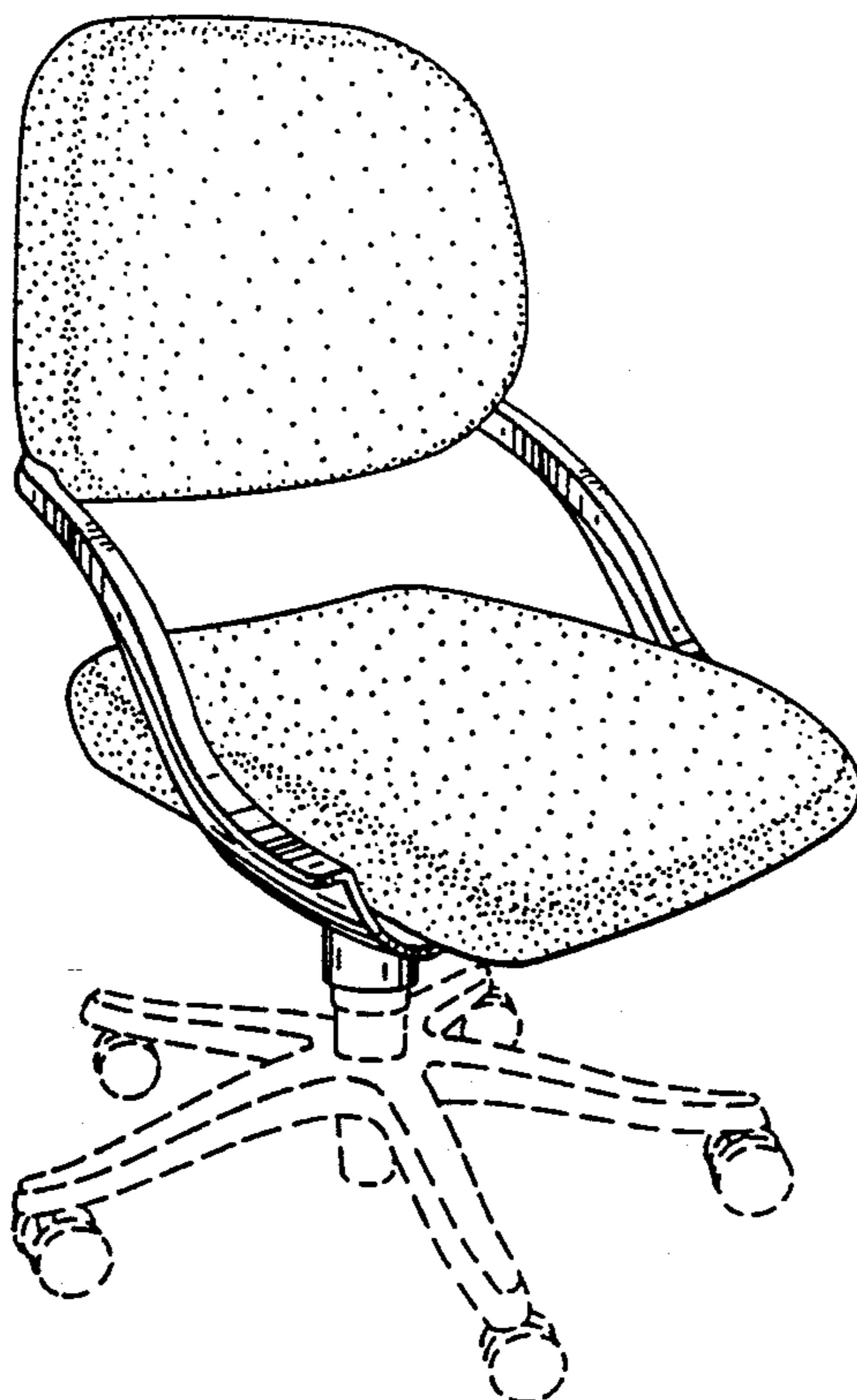

FIG. 1

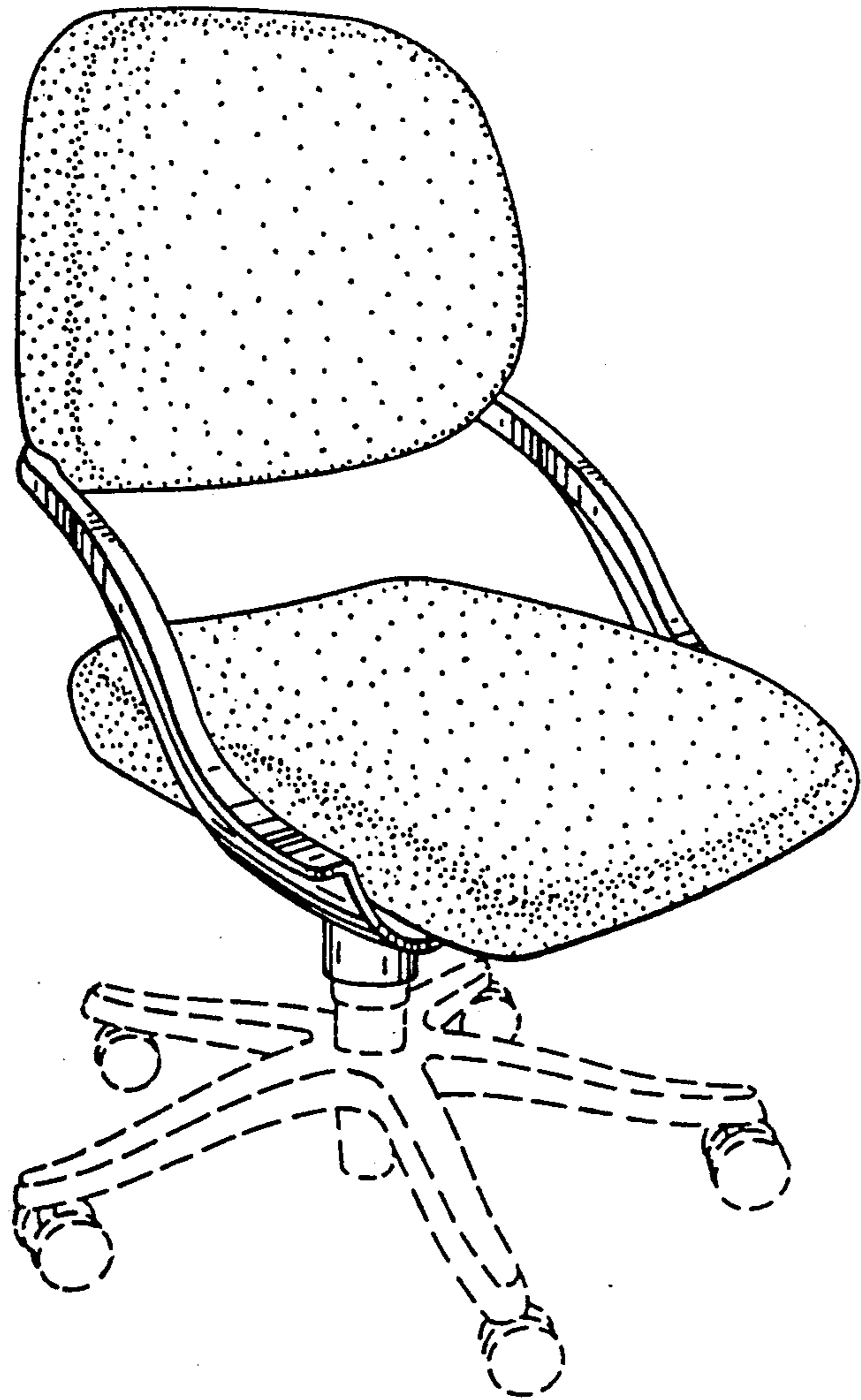
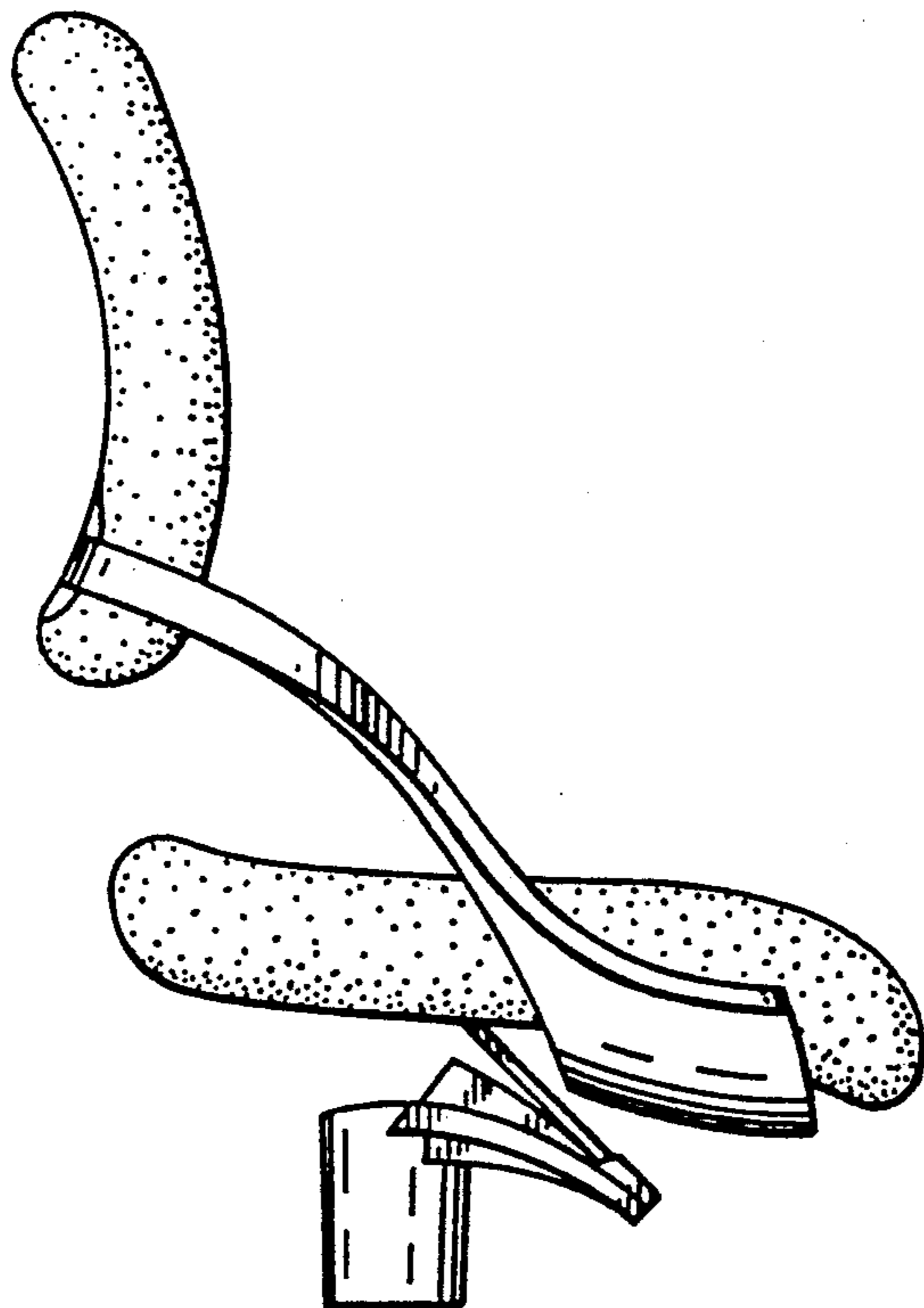

FIG. 2



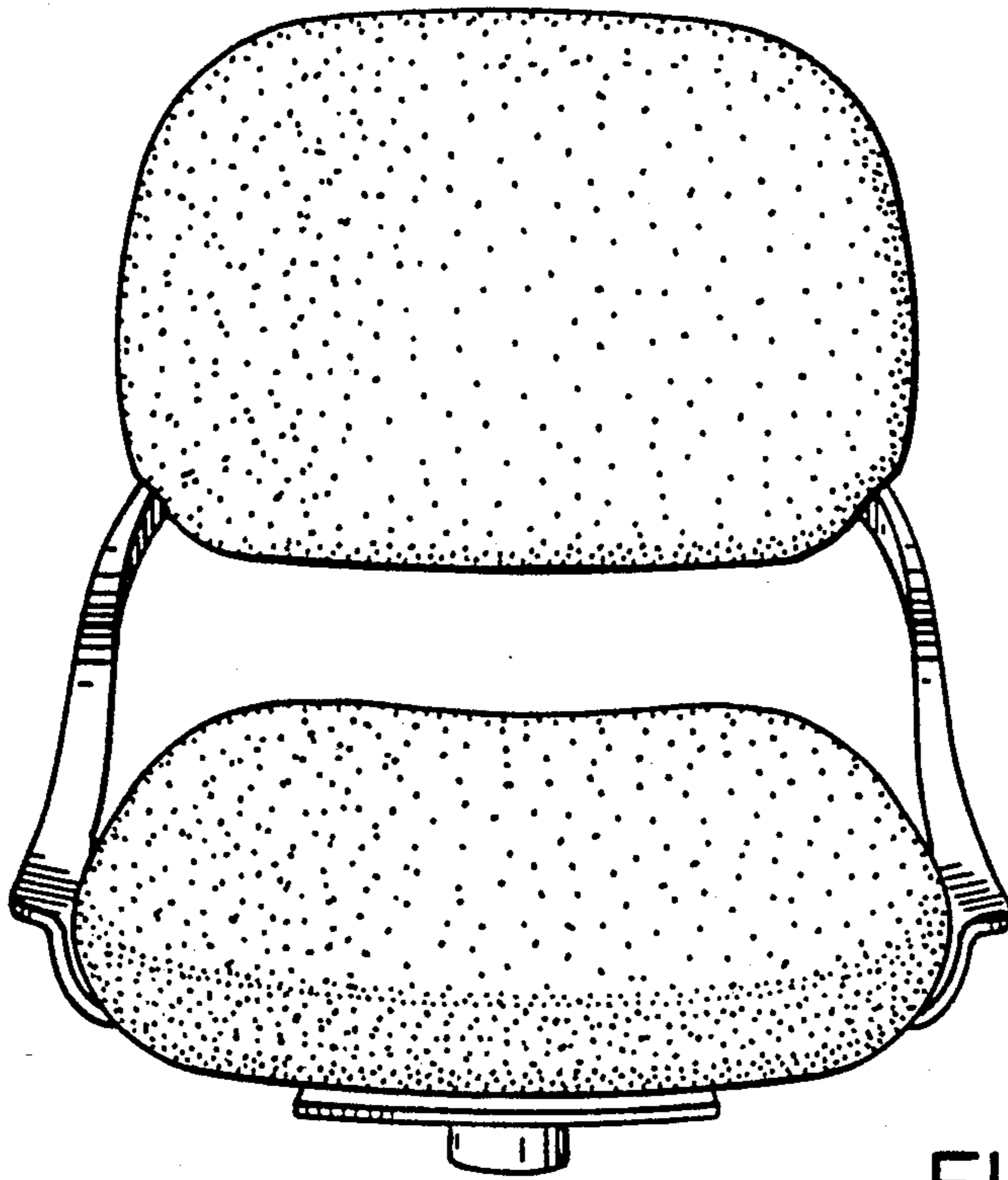

FIG. 3

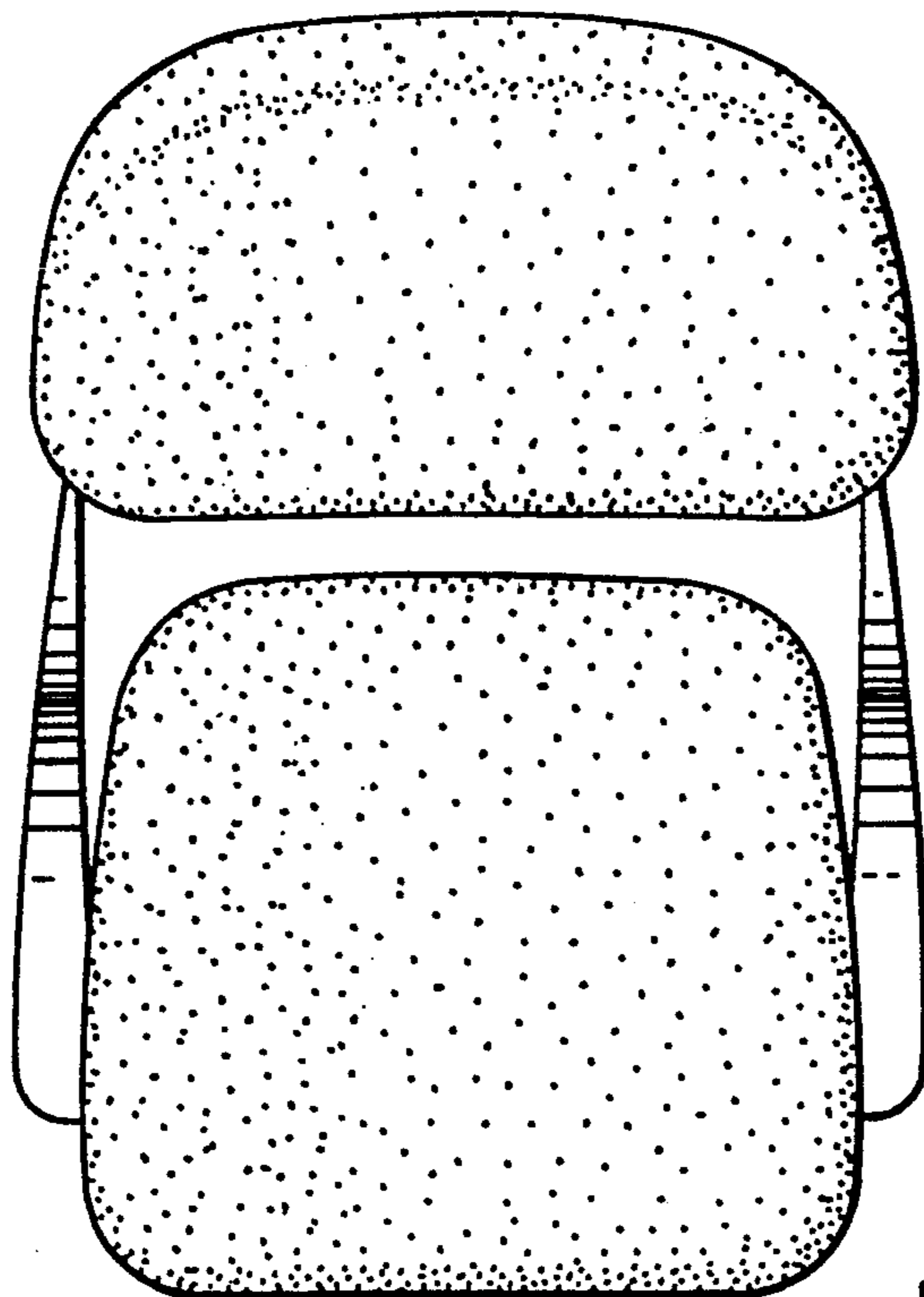

FIG. 4



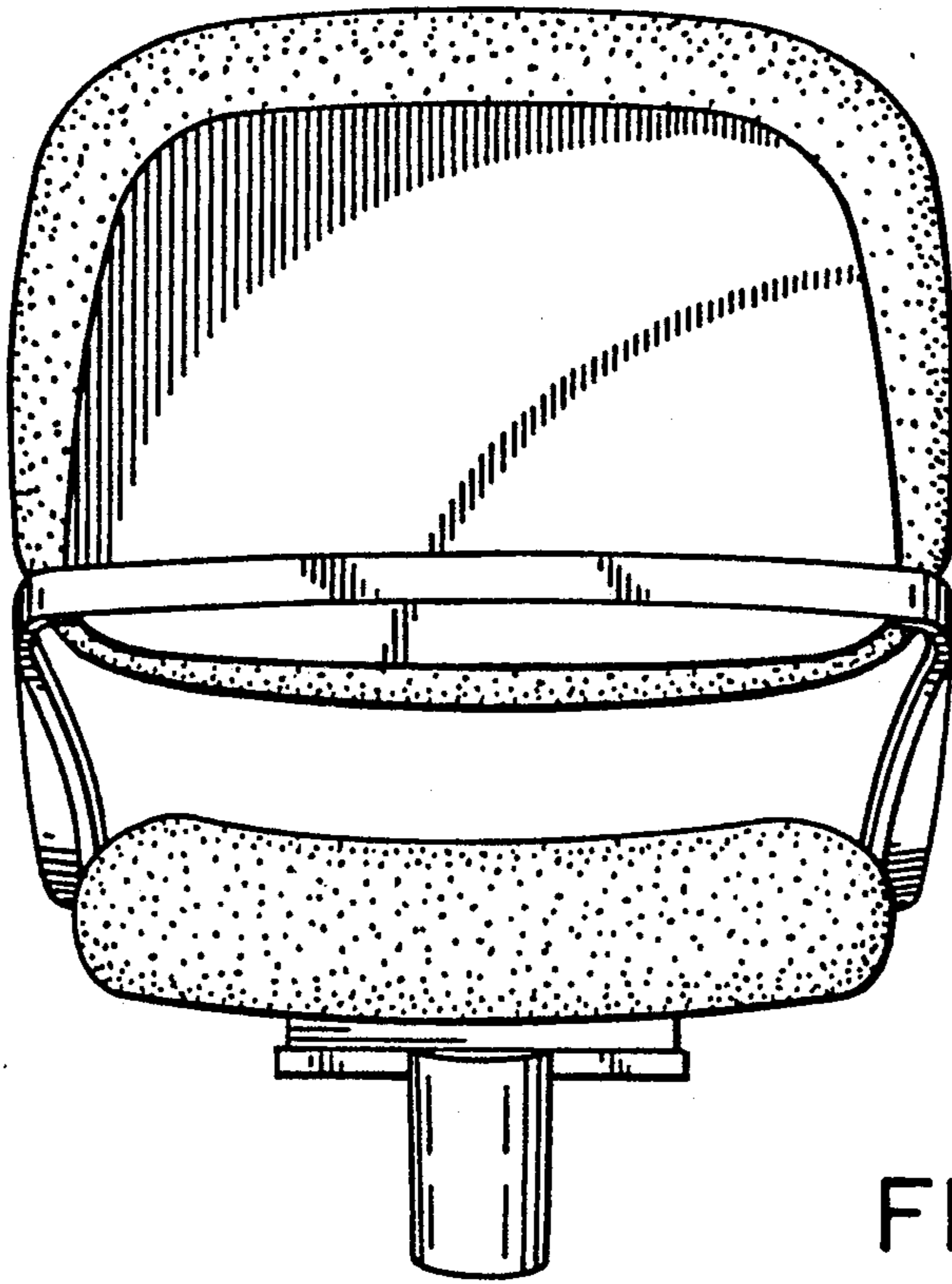

FIG. 5

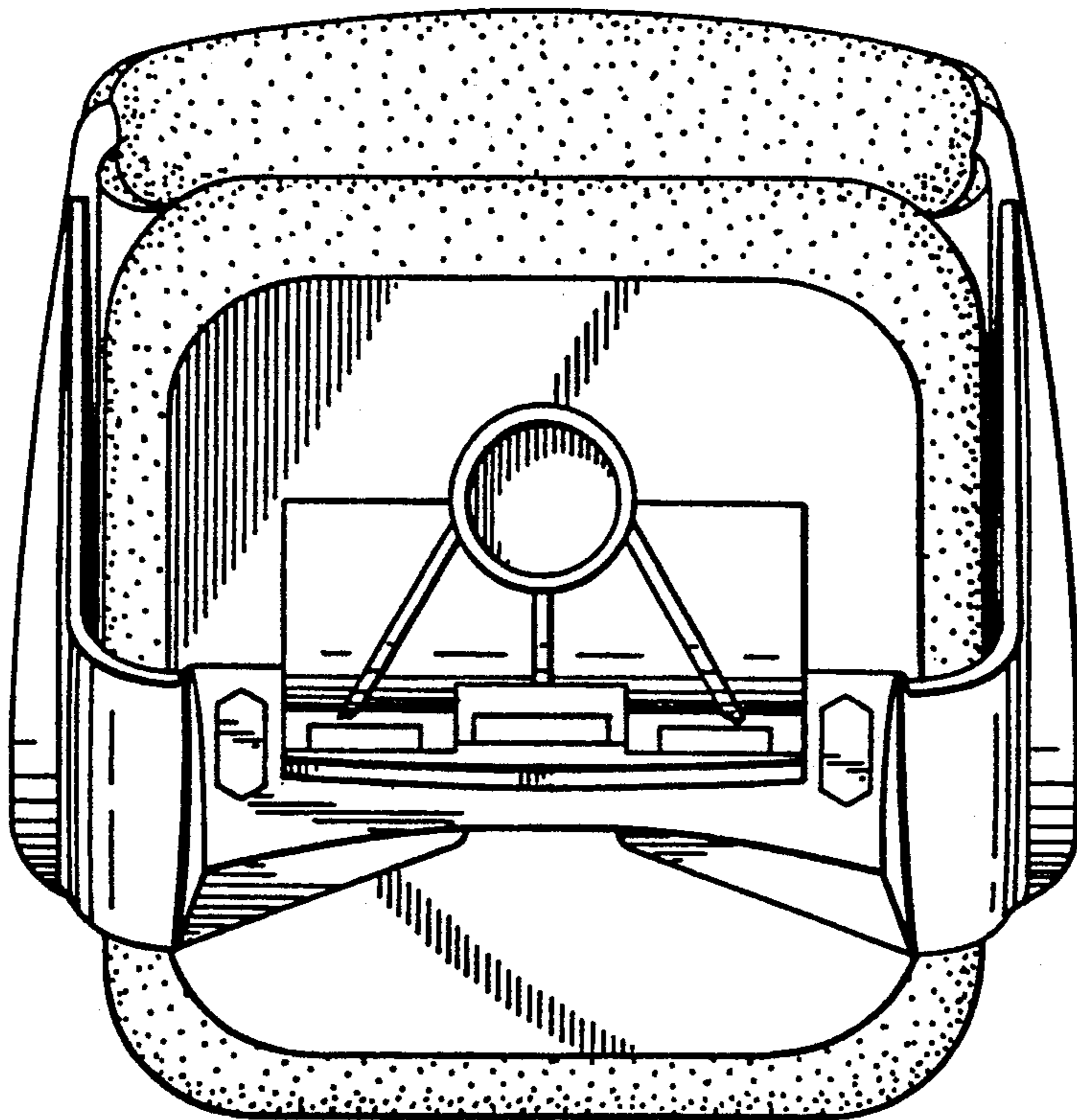

FIG. 6