



US00D335405S

United States Patent [19]

[11] Patent Number: Des. 335,405

Tiedge

[45] Date of Patent: ** May 11, 1993

[54] LITTLE LEAGUE EQUIPMENT STAND

[76] Inventor: William F. Tiedge, 380 McKinley St., West Hempstead, N.Y. 11552

[**] Term: 14 Years

[21] Appl. No.: 682,222

[22] Filed: Apr. 9, 1991

[52] U.S. Cl. D6/467; D6/562

[58] Field of Search D6/396, 449, 466-468, D6/462-465, 473, 416, 552; D23/403; 211/13, 14, 60.1, 70.2; D21/223; 224/223, 274, 42.15 R, 42.11

D. 201,686 7/1965 Hobson, Jr. D23/403
D. 312,016 11/1990 Montgomery D6/467
4,227,710 10/1980 Laub 211/60.1 X

Primary Examiner—Alan P. Douglas
Assistant Examiner—Jeffrey Asch
Attorney, Agent, or Firm—Leon Gilden

[57] CLAIM

The ornamental design for a little league equipment stand, as shown and described.

DESCRIPTION

FIG. 1 is a front elevational view of the little league equipment stand showing my new design; FIG. 2 is a rear elevational view thereof; FIG. 3 is a left side elevational view thereof; FIG. 4 is a right side elevational view thereof; FIG. 5 is a top plan view thereof; FIG. 6 is a bottom plan view thereof; and, FIG. 7 is a perspective view thereof.

[56] References Cited

U.S. PATENT DOCUMENTS

D. 44,078 5/1913 Treadway D6/468
D. 108,611 3/1938 Best D6/464
D. 162,207 2/1951 Meitenleiter D6/467

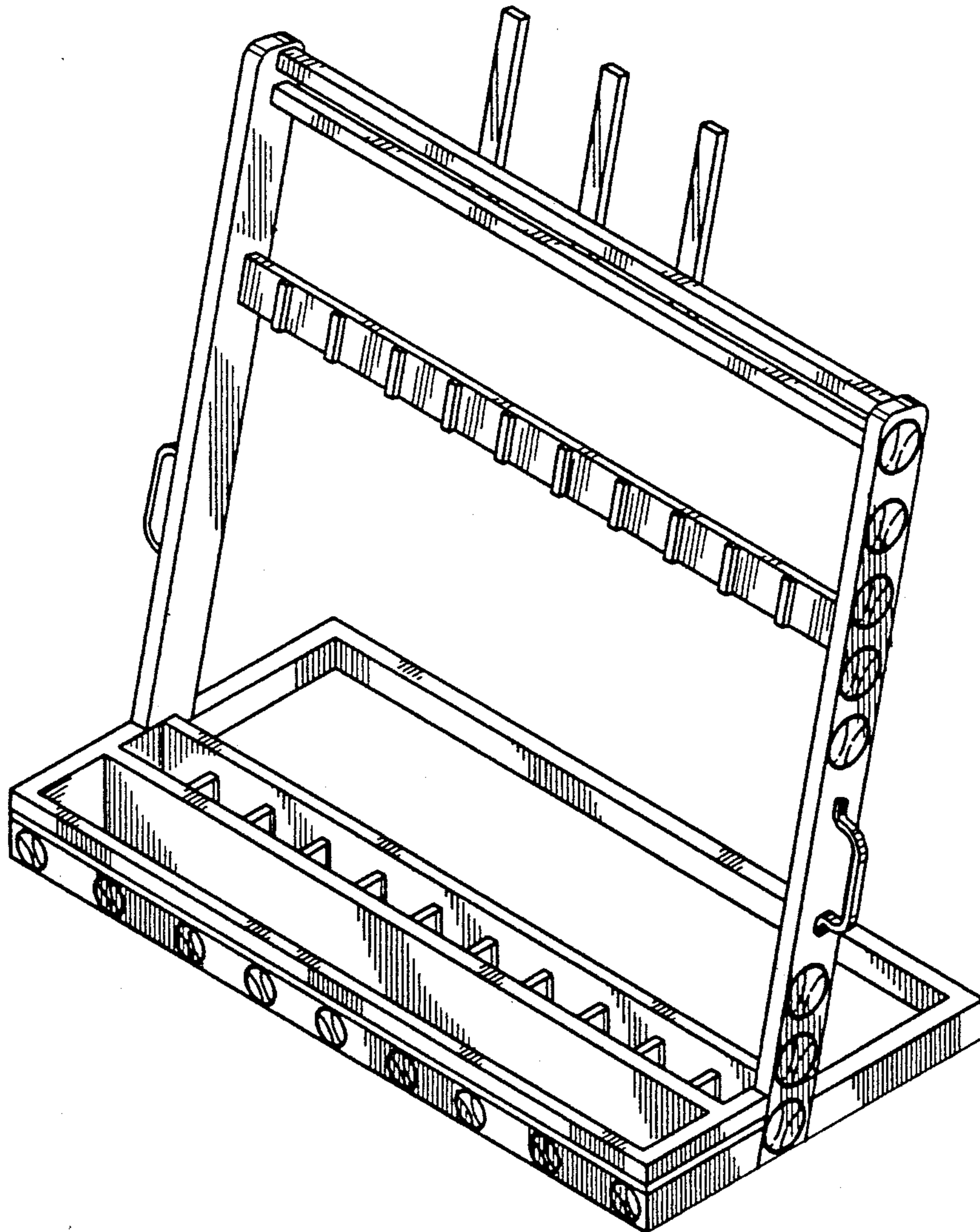

FIG. 1

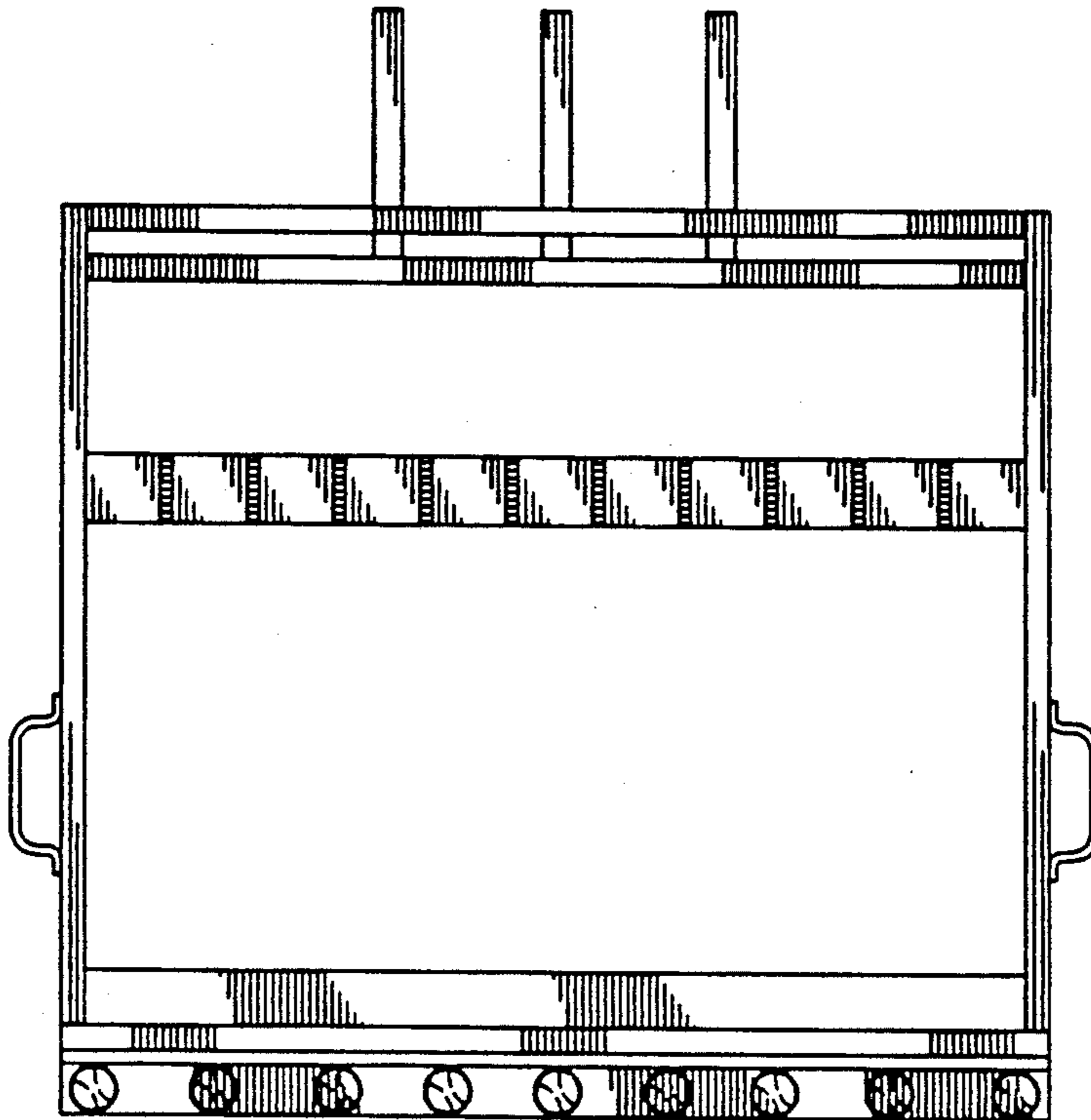

FIG. 2

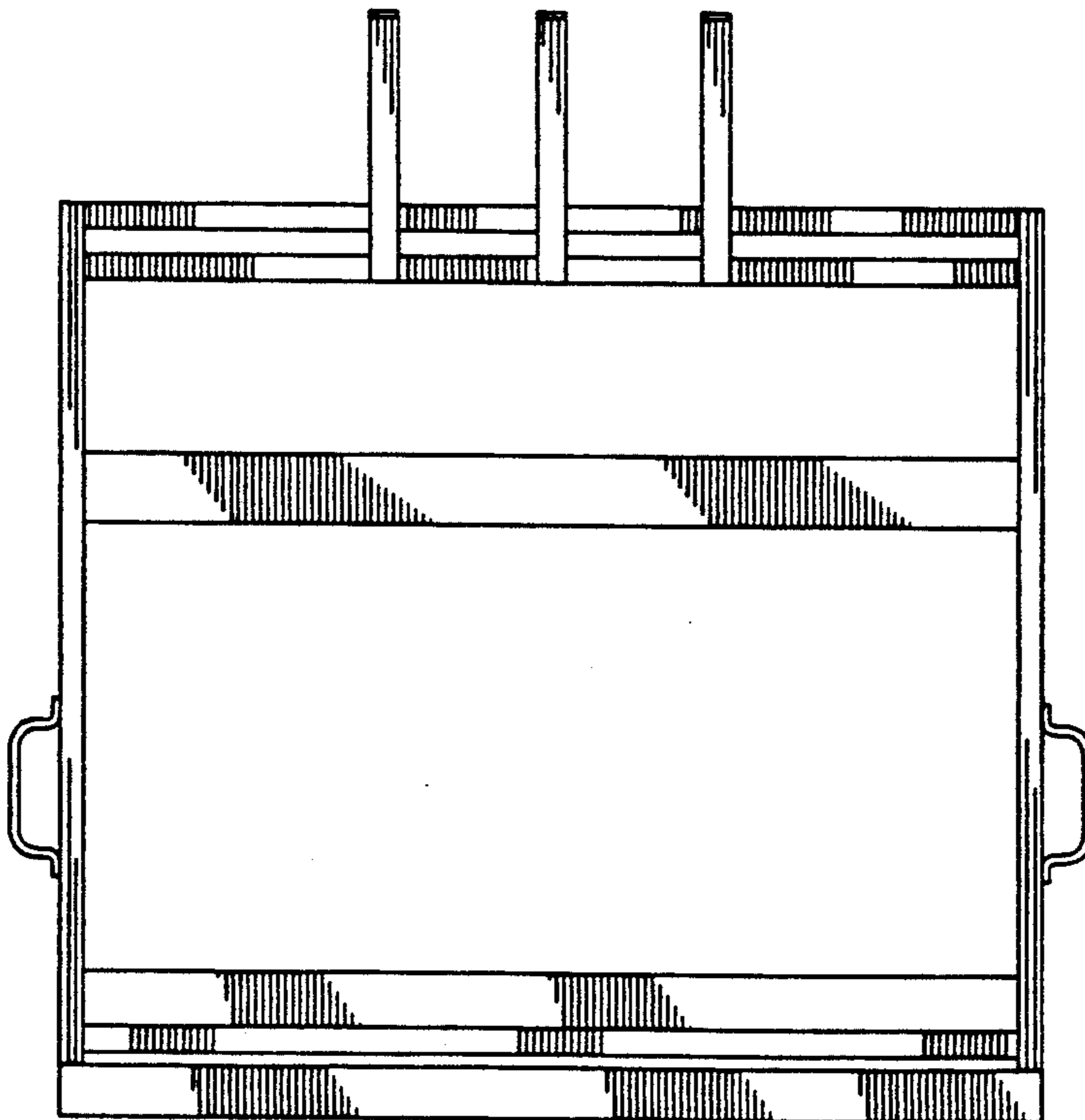

FIG. 3

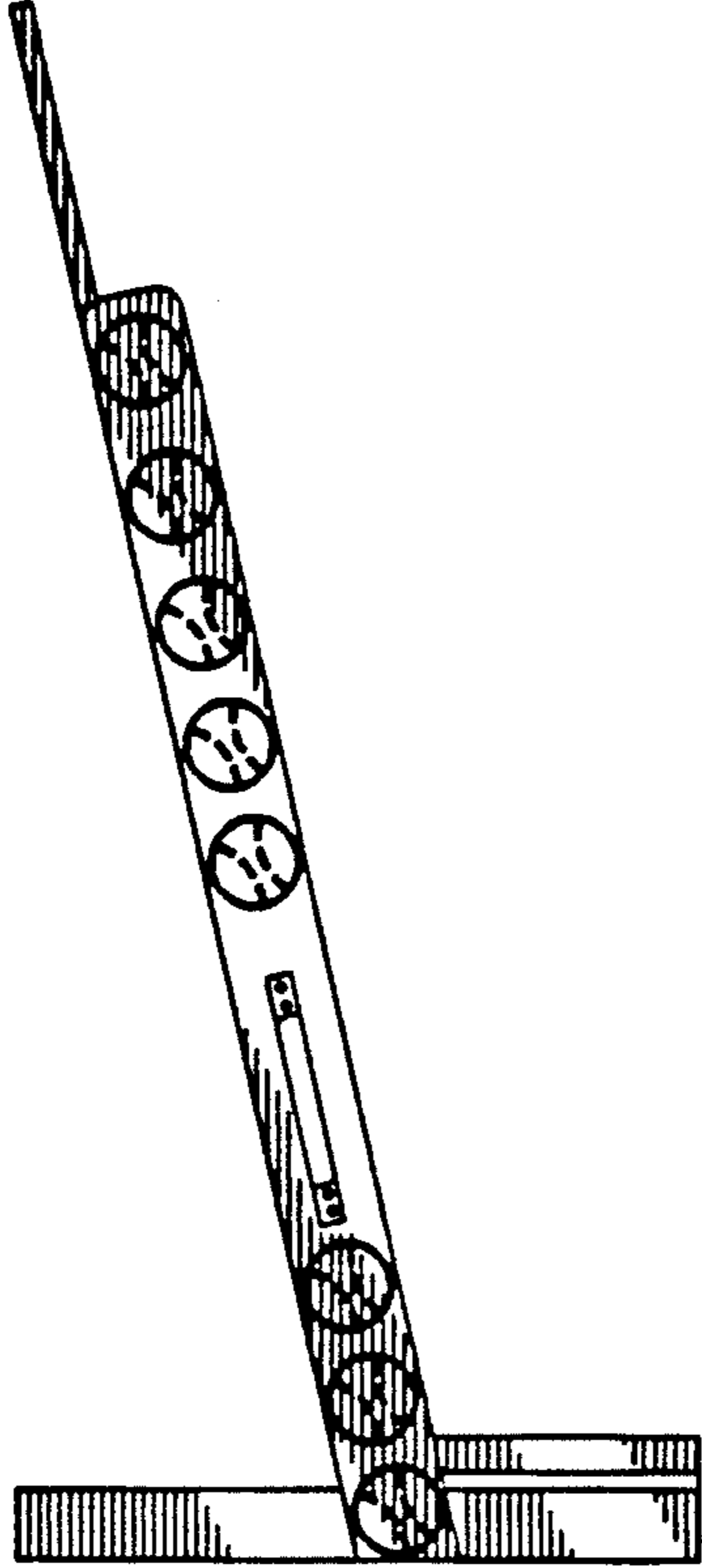

FIG. 4

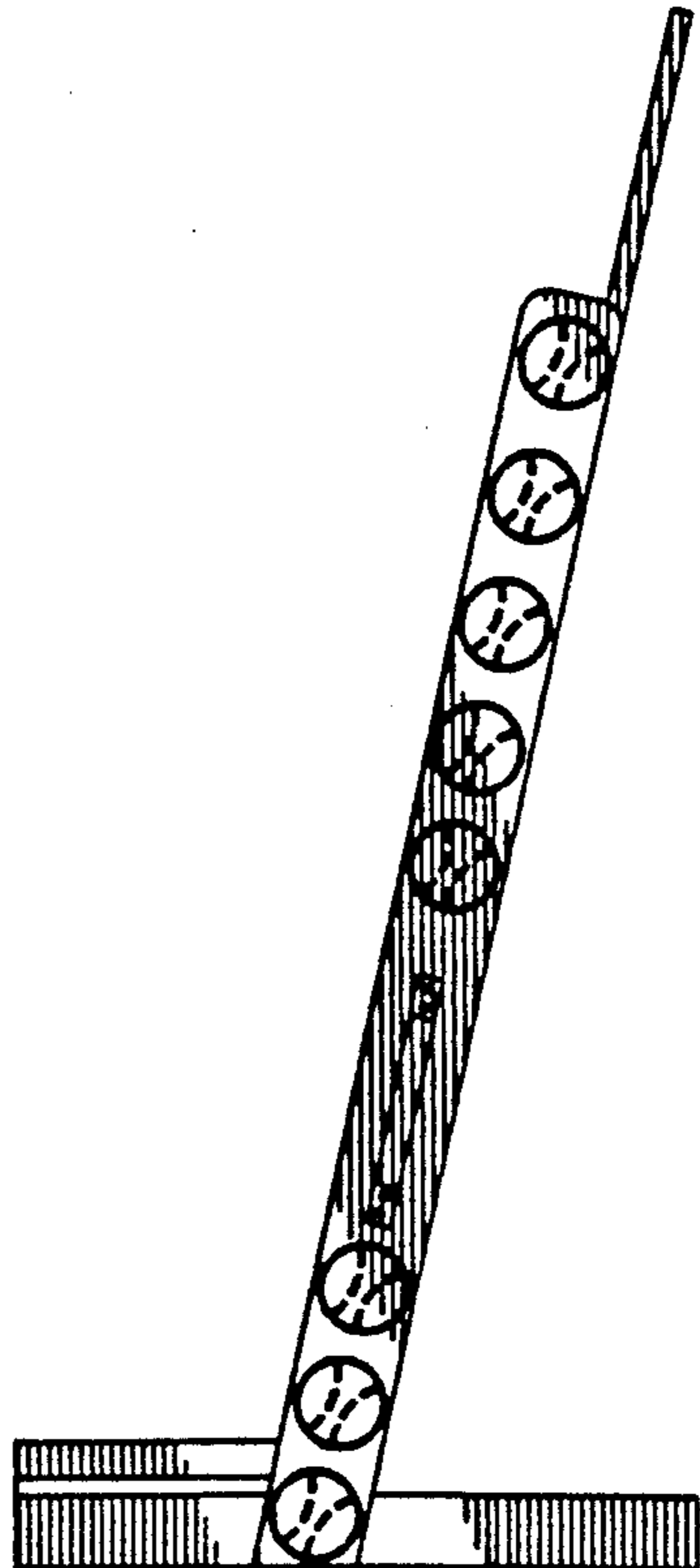

FIG. 5

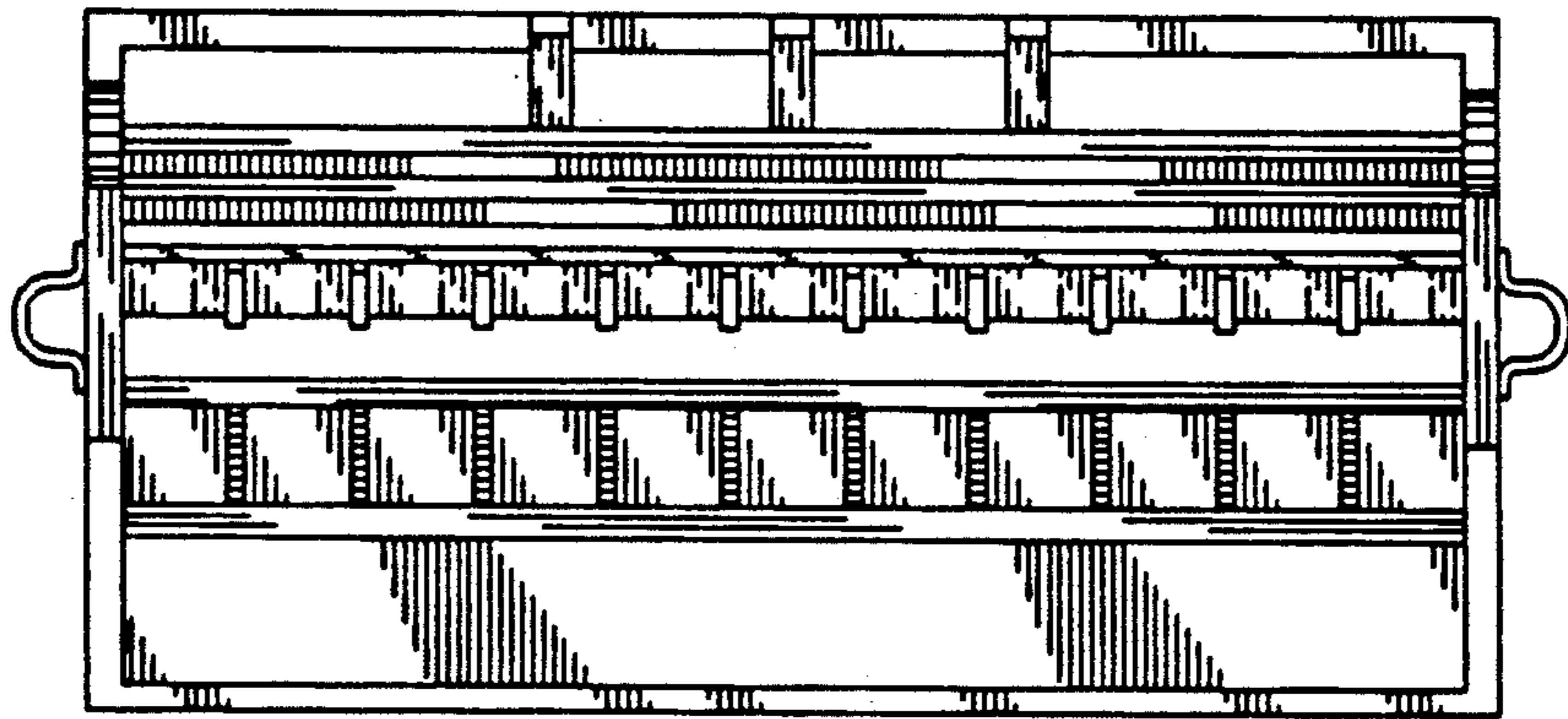

FIG. 6

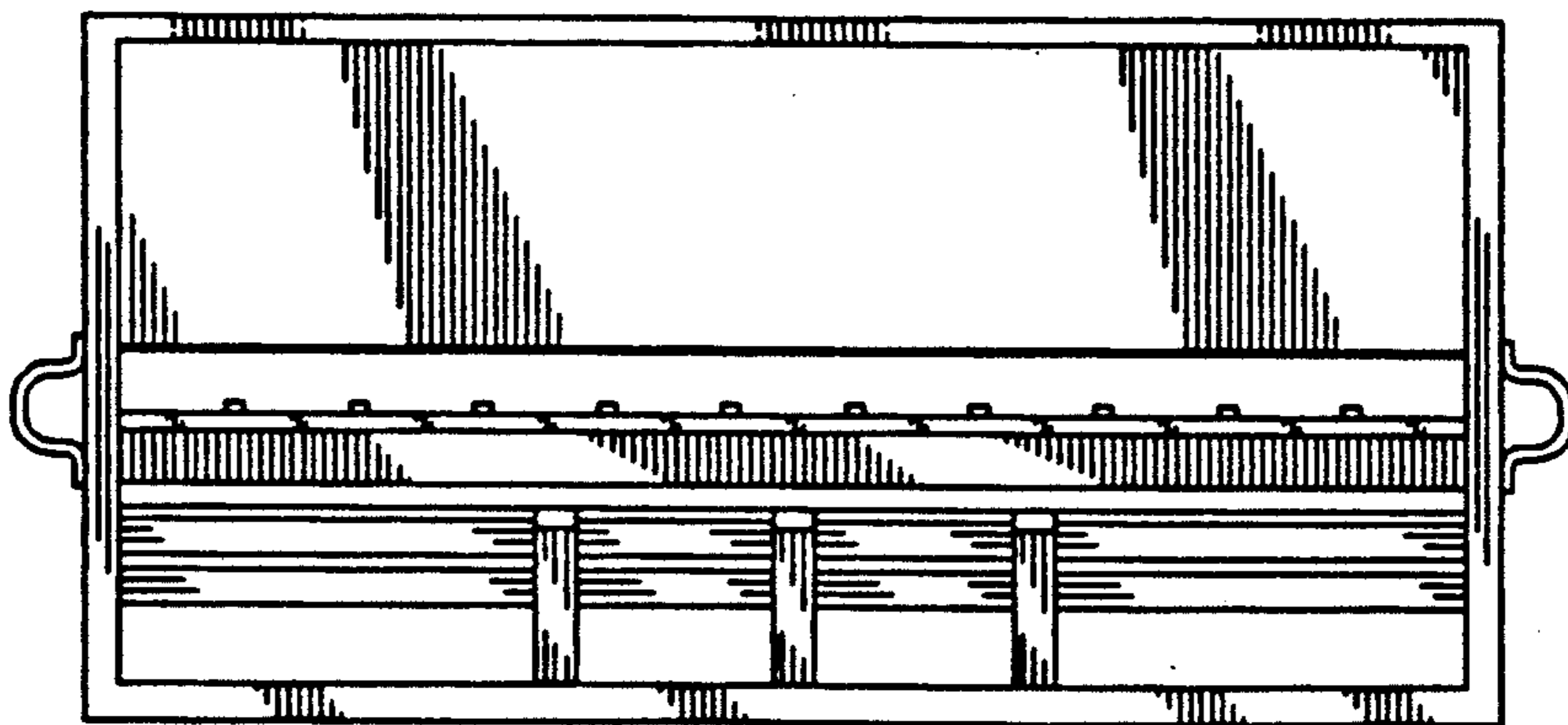

FIG. 7

