



US00D335399S

United States Patent [19]

Hubbard

[11] Patent Number: Des. 335,399

[45] Date of Patent: ** May 11, 1993

[54] BLANKET RACK

[76] Inventor: Timothy R. Hubbard, 6759W 450N,
Michigan City, Ind. 46360

[**] Term: 14 Years

[21] Appl. No.: 764,935

[22] Filed: Sep. 30, 1991

[52] U.S. Cl. D6/412; D6/410;
D6/450; 248/915

[58] Field of Search D6/410-415,
D6/450-453, 462-465, 396, 449; 211/13, 106,
181; 248/915, 102, 105, 103

[56] **References Cited**

U.S. PATENT DOCUMENTS

D. 56,339	10/1920	Carter	D6/412
D. 82,446	11/1930	Muller	D6/412
D. 91,027	11/1933	Guild	D6/410
D. 277,720	7/1973	Rau, Sr.	D6/412 X
D. 287,078	12/1986	Bowsher	D6/450
D. 313,900	1/1991	Yau Kee	D6/410

D. 315,264	3/1991	Rives et al.	D6/449 X
D. 316,342	4/1991	Kee	D6/410
D. 320,322	10/1991	Hendrix	D6/474 X

OTHER PUBLICATIONS

House & Garden Nov. 1984, p. 191, Cactus Coat Rack.

Primary Examiner—Alan P. Douglas

Assistant Examiner—Jeffrey Asch

Attorney, Agent, or Firm—James D. Hall

[57] **CLAIM**

The ornamental design for a blanket rack, as shown and described.

DESCRIPTION

FIG. 1 is a side perspective view of a blanket rack showing my new design;

FIG. 2 is a left side elevational view thereof;

FIG. 3 is a right side elevational view thereof;

FIG. 4 is a bottom plan view thereof;

FIG. 5 is a top plan view thereof; and,

FIG. 6 is a front elevational view thereof, the rear elevational view being a mirror image of that shown.

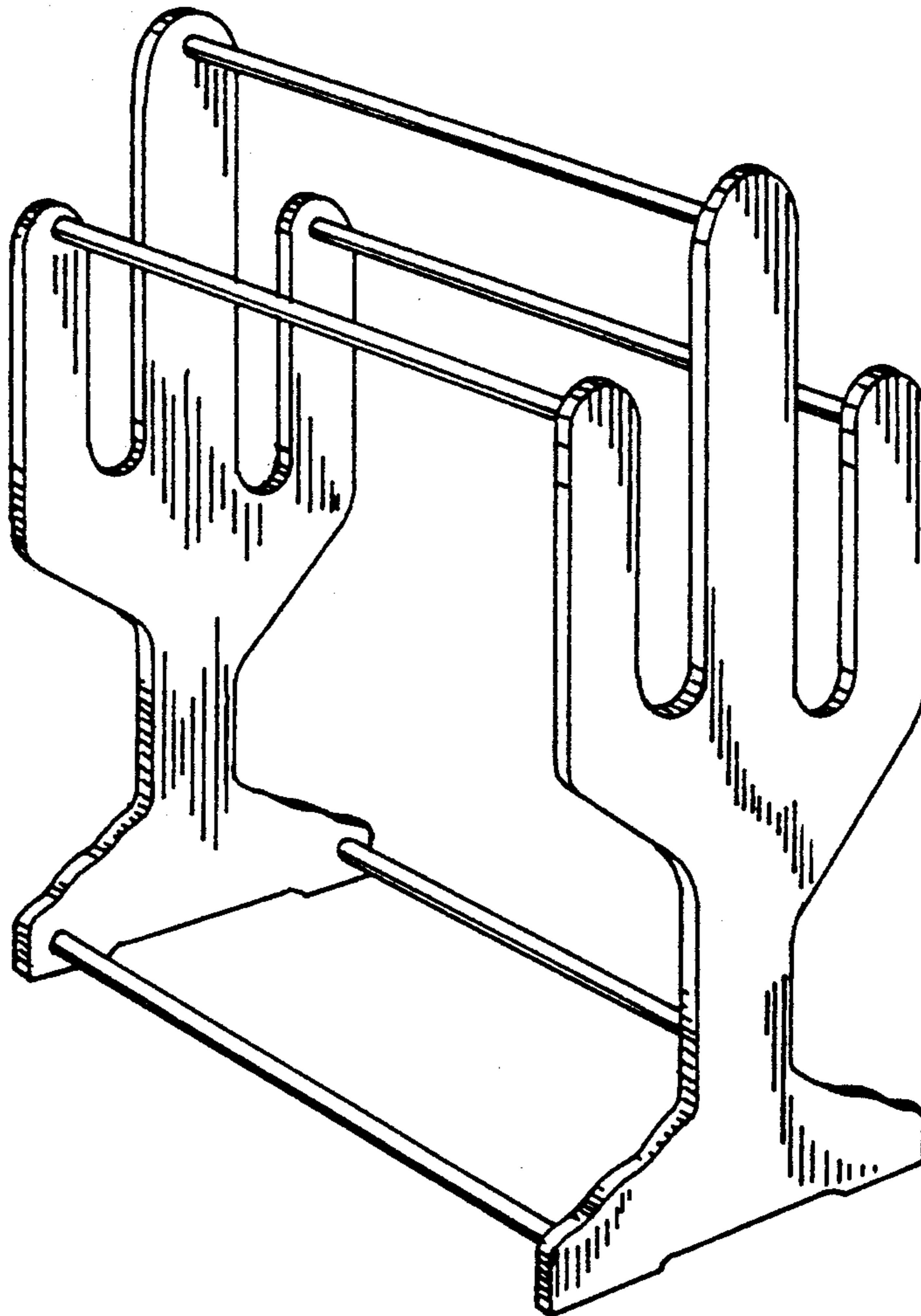

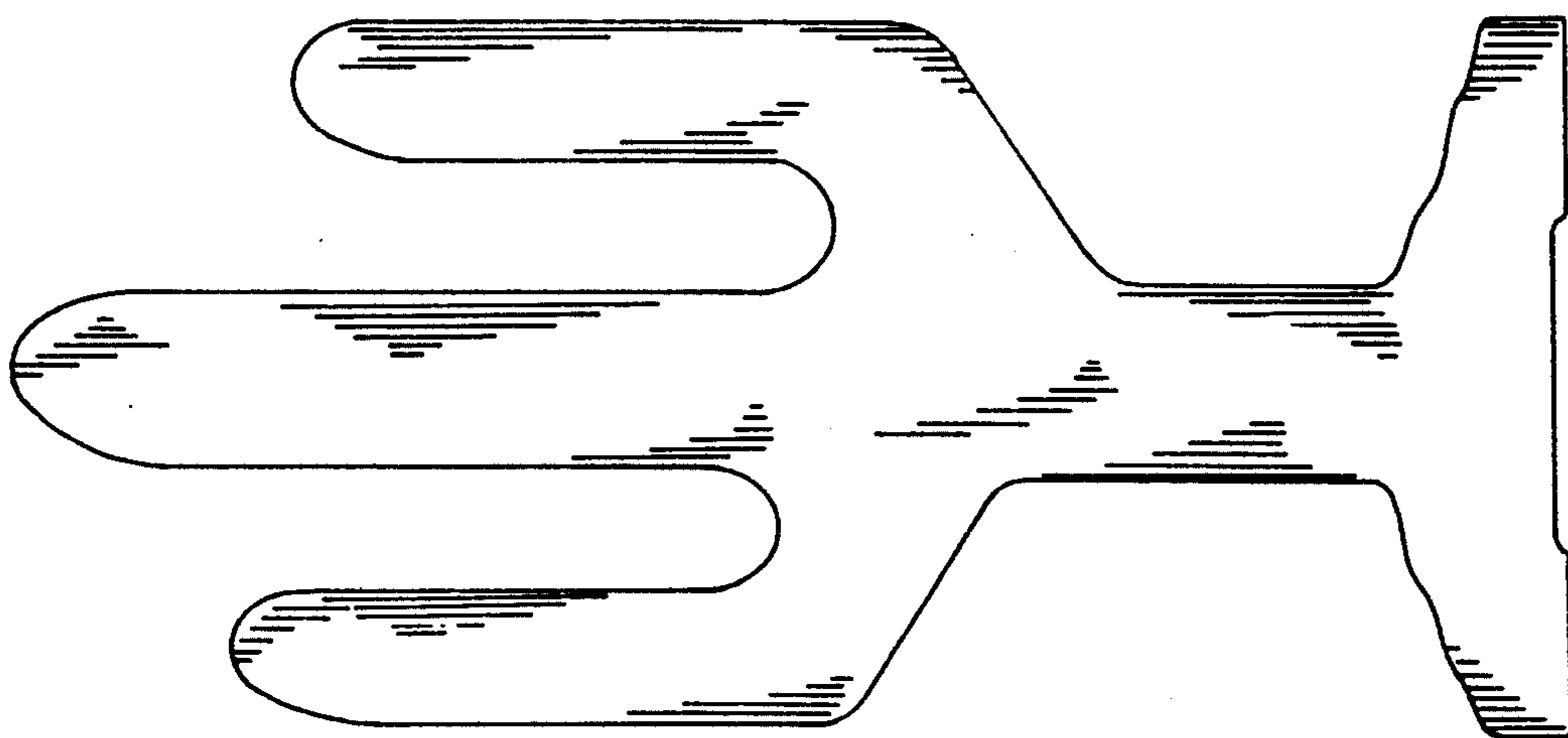

FIG. 3

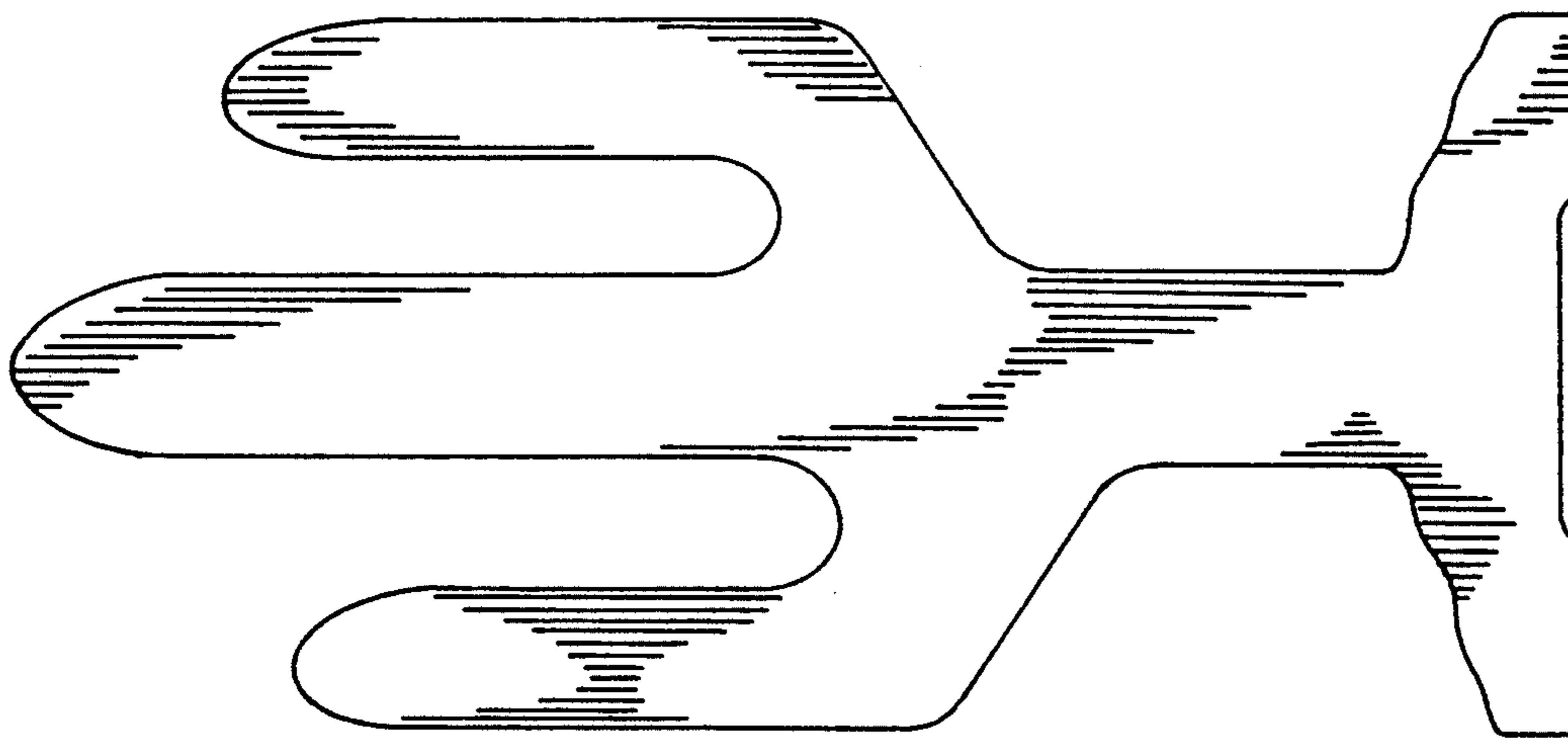

FIG. 2

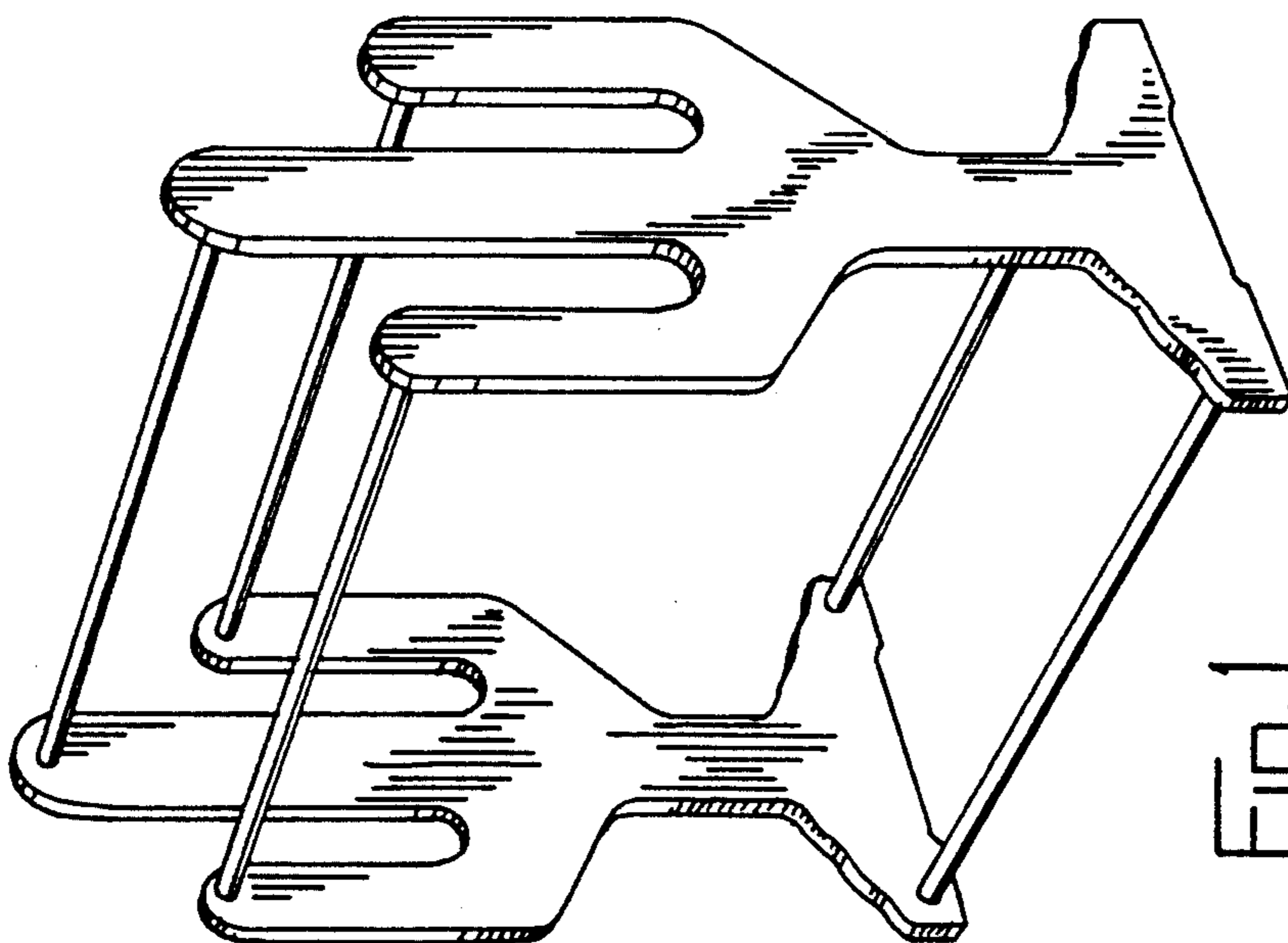

FIG. 1

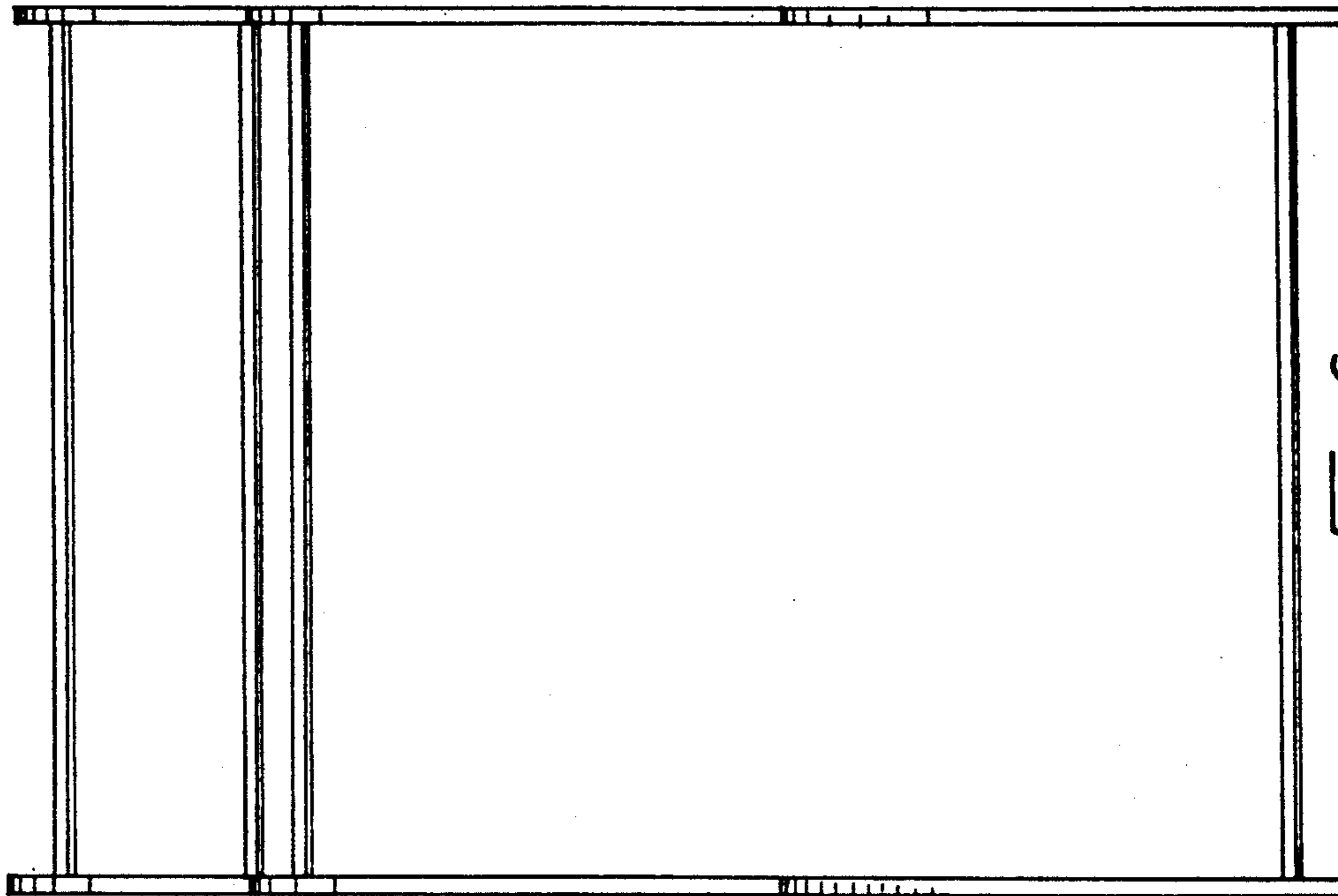

FIG. 6

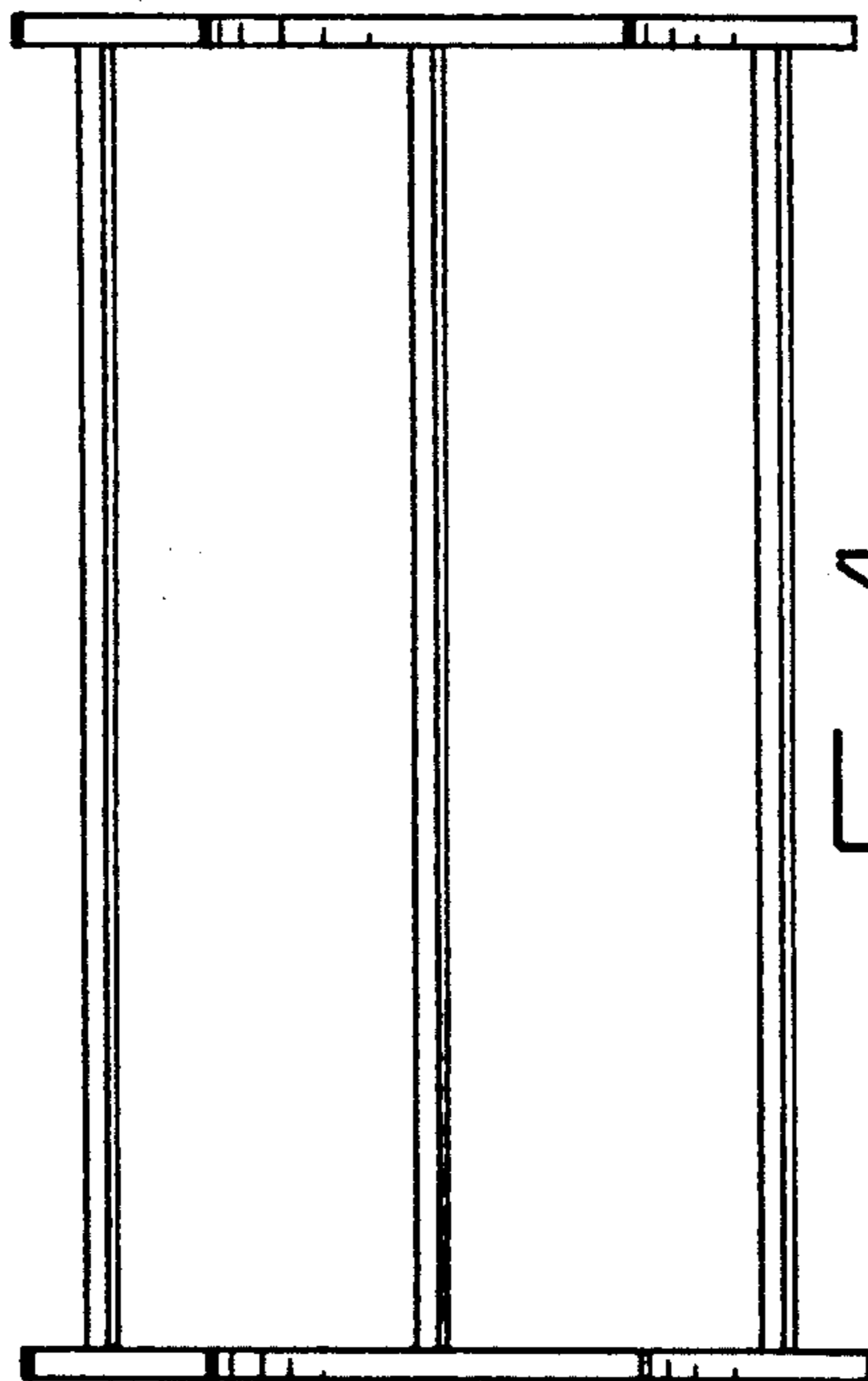

FIG. 4

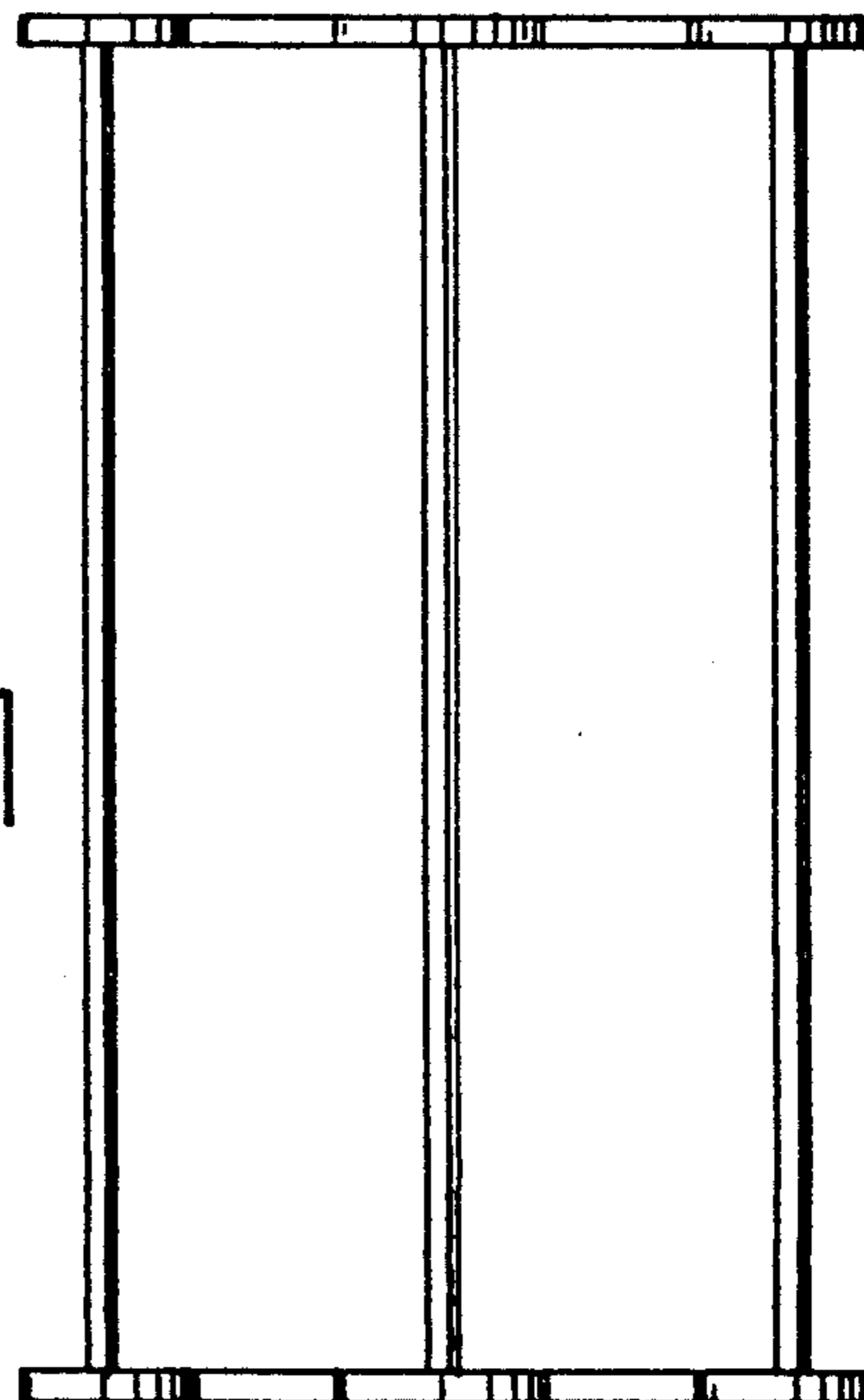

FIG. 5