



US00D335371S

# United States Patent [19]

[11] Patent Number: **Des. 335,371**

Meade

[45] Date of Patent: **\*\* May 4, 1993**

- [54] CLOTHES LINE CLIP
- [75] Inventor: **Ronald G. Meade, Seaton Park, Australia**
- [73] Assignee: **Hills Industries Limited, Edwardstown, Australia**
- [\*\*] Term: **14 Years**
- [21] Appl. No.: **574,243**
- [22] Filed: **Aug. 28, 1990**
- [30] Foreign Application Priority Data
  - Mar. 2, 1990 [AU] Australia ..... 667/90
- [52] U.S. Cl. .... **D32/60; D8/382; D8/395**
- [58] Field of Search ..... **D8/382, 383, 394, 395; 24/336; 403/294; D82/60-65**
- [56] References Cited
  - U.S. PATENT DOCUMENTS**
  - D. 136,783 12/1943 LeVeck ..... D32/60
  - D. 162,767 4/1951 Adams ..... D32/60
  - D. 271,467 11/1983 Sakaguchi ..... D8/395

- D. 276,272 11/1984 Weissenburger ..... D8/394
- D. 307,108 4/1990 Morita ..... D8/382
- 1,459,115 6/1923 Pedersen ..... D32/60
- 3,797,076 3/1974 Watkin ..... D32/61

### OTHER PUBLICATIONS

Richco catalog ©1986 p. 32 wire saddle, model LWS.

*Primary Examiner*—Bernard Ansher  
*Assistant Examiner*—Sandra Morris  
*Attorney, Agent, or Firm*—Rodman & Rodman

### [57] CLAIM

The ornamental design for a clothes line clip, as shown.

### DESCRIPTION

FIG. 1 is a top perspective view of a clothes line clip, showing my new design;  
 FIG. 2 is a bottom perspective view thereof;  
 FIG. 3 is a top plan view thereof;  
 FIG. 4 is a front elevational view thereof;  
 FIG. 5 is a bottom plan view thereof;  
 FIG. 6 is a right end elevational view thereof;  
 FIG. 7 is a left end elevational view thereof; and,  
 FIG. 8 is a rear end elevational view thereof.

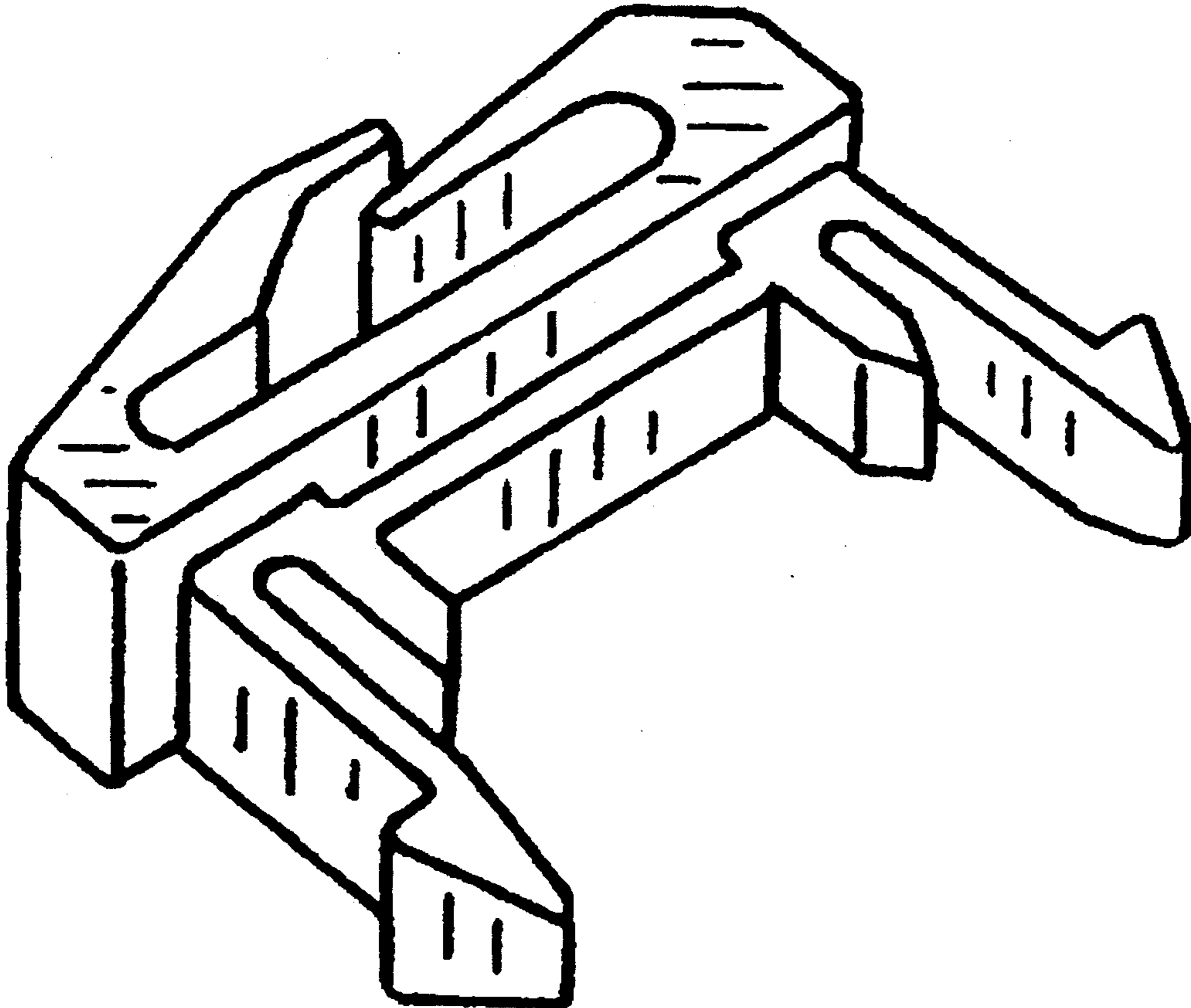

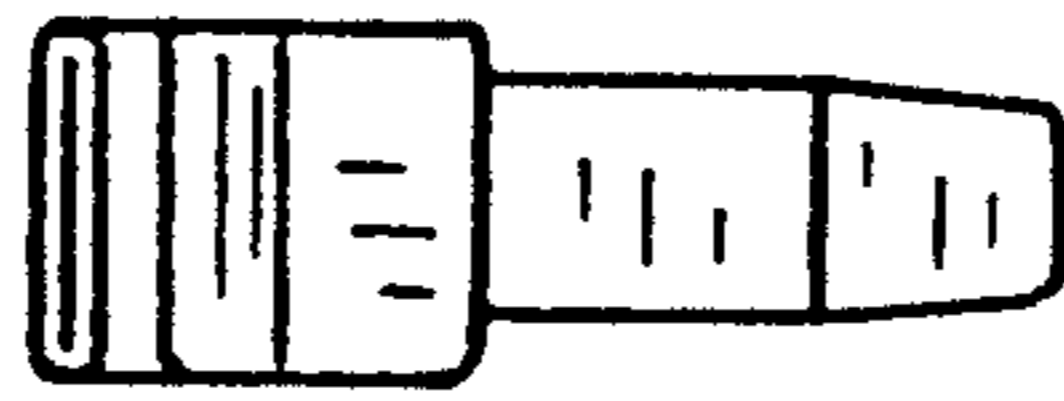

FIG. 6

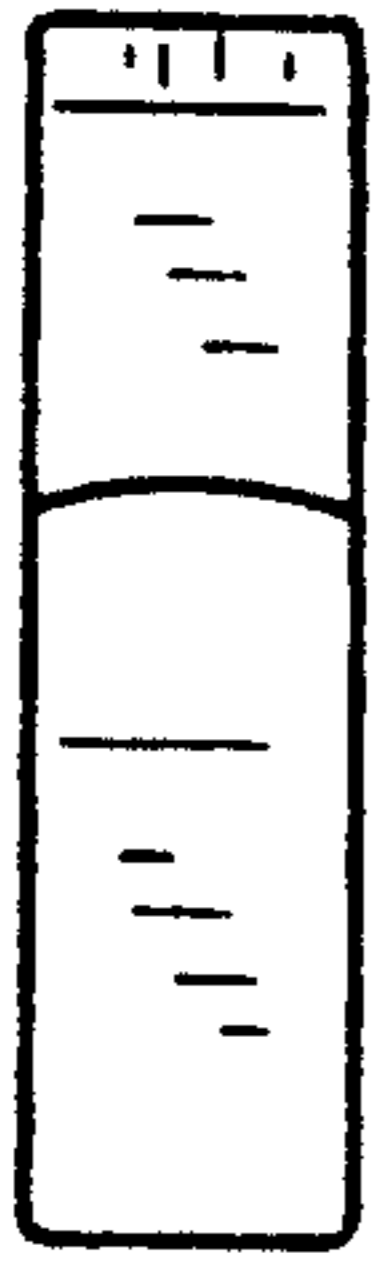

FIG. 3

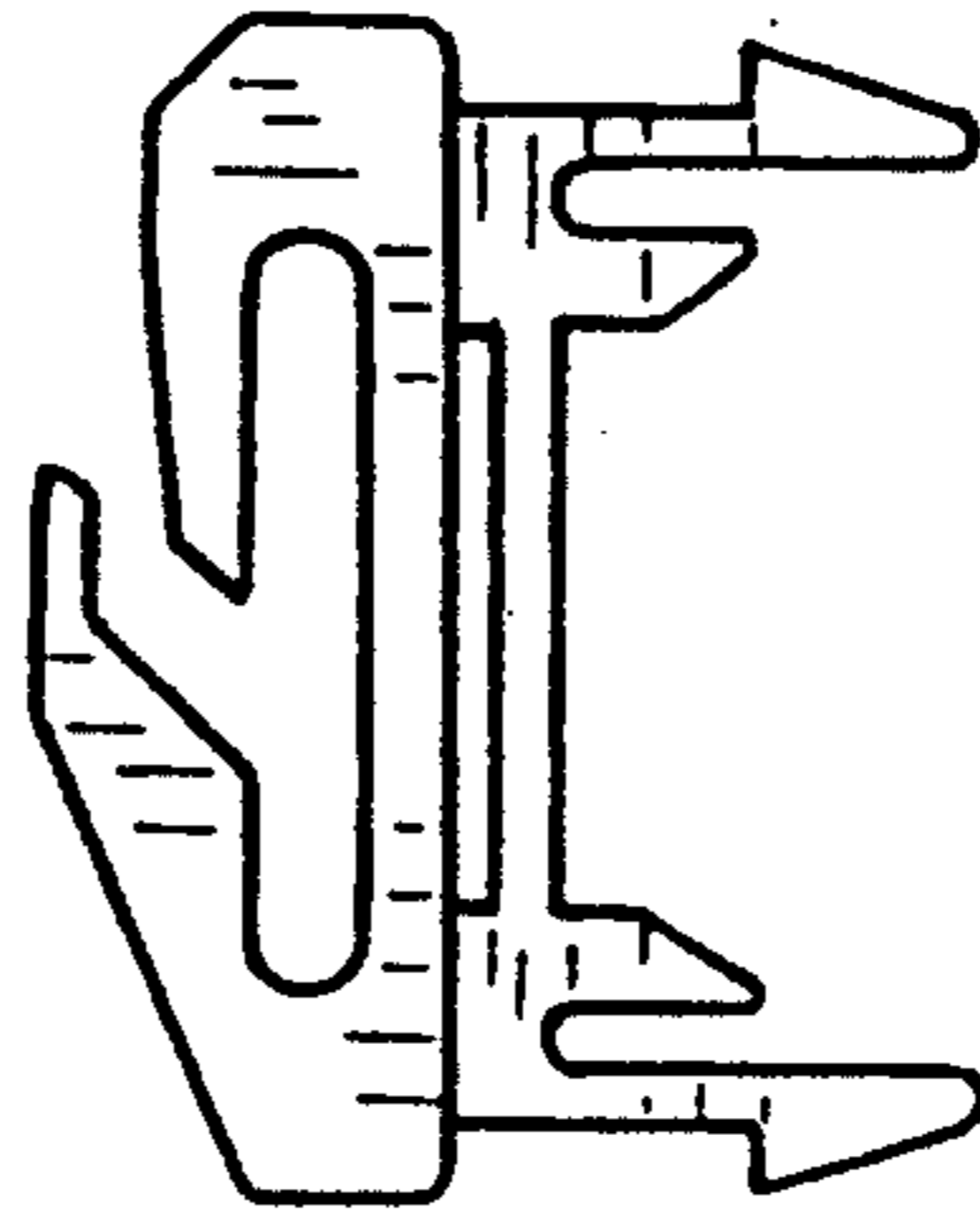

FIG. 4

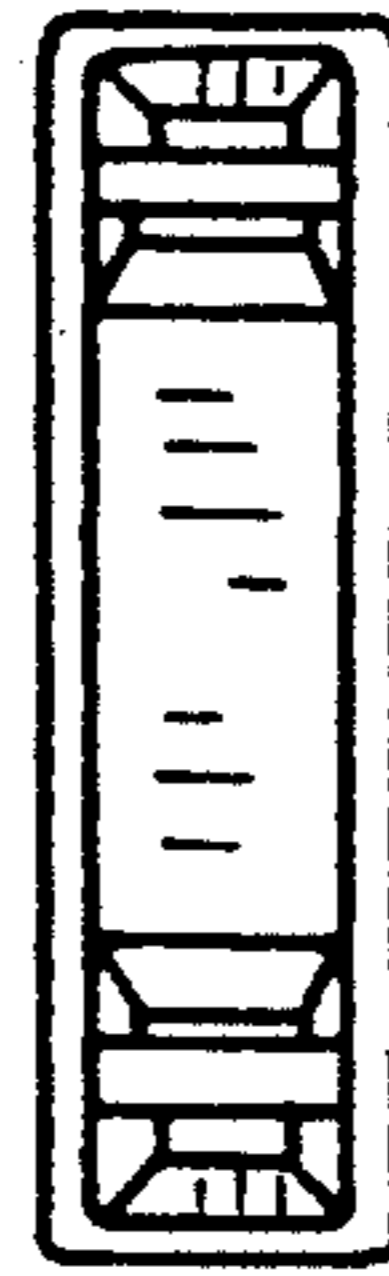

FIG. 5

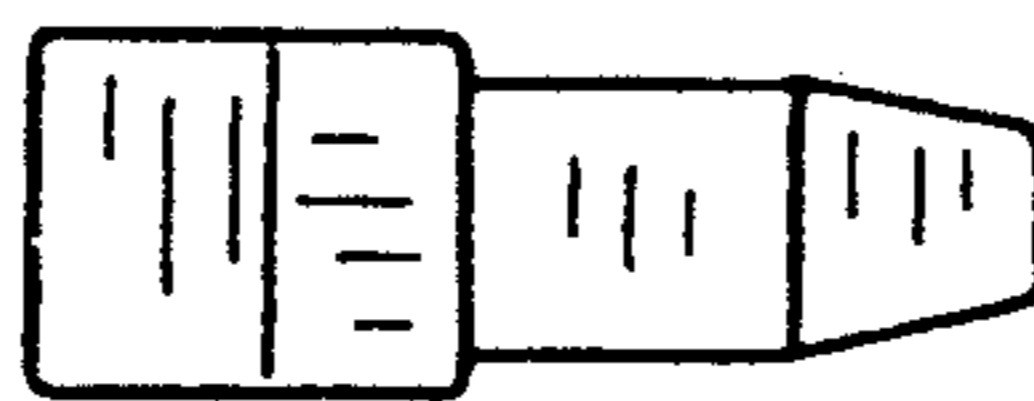

FIG. 7

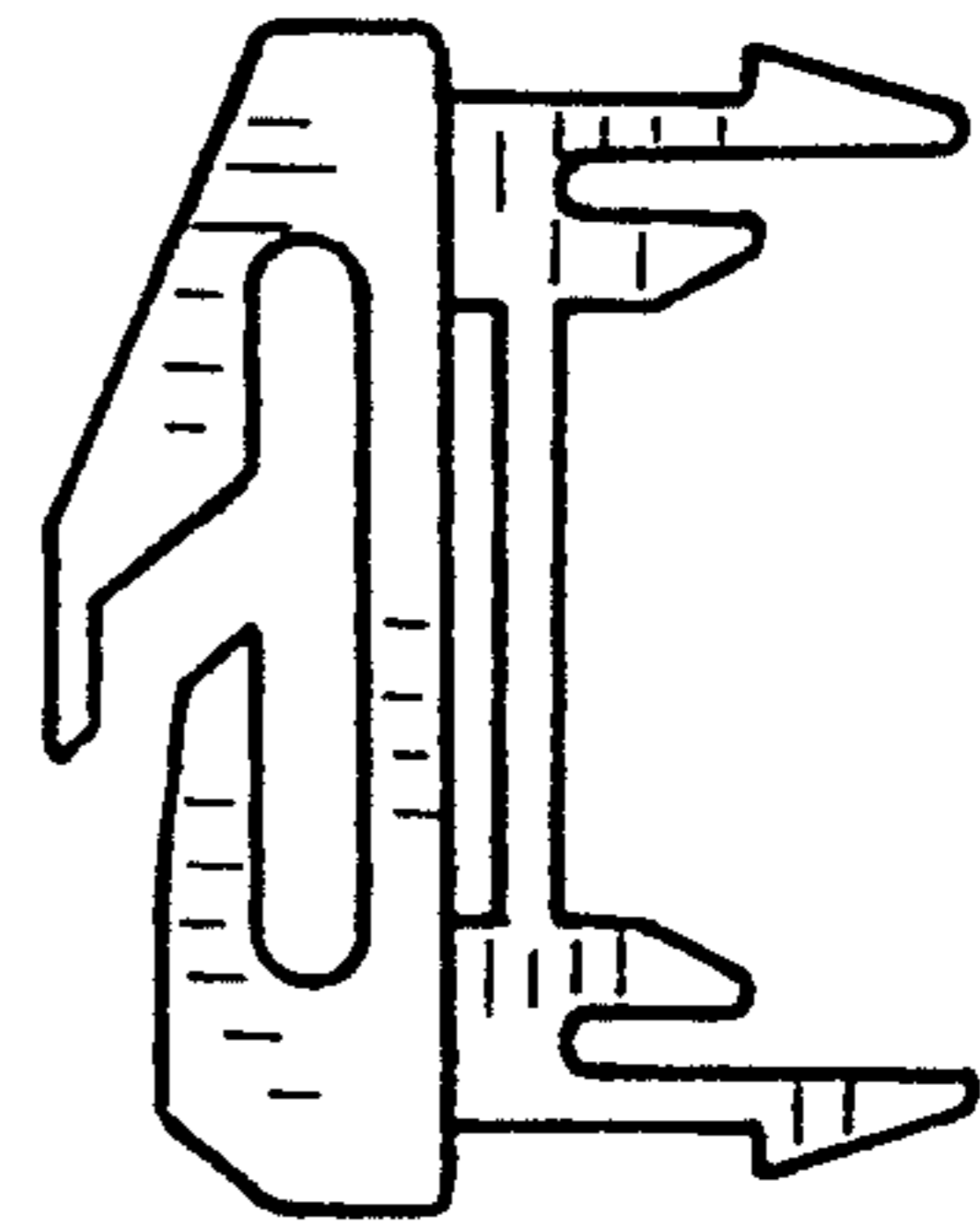

FIG. 8

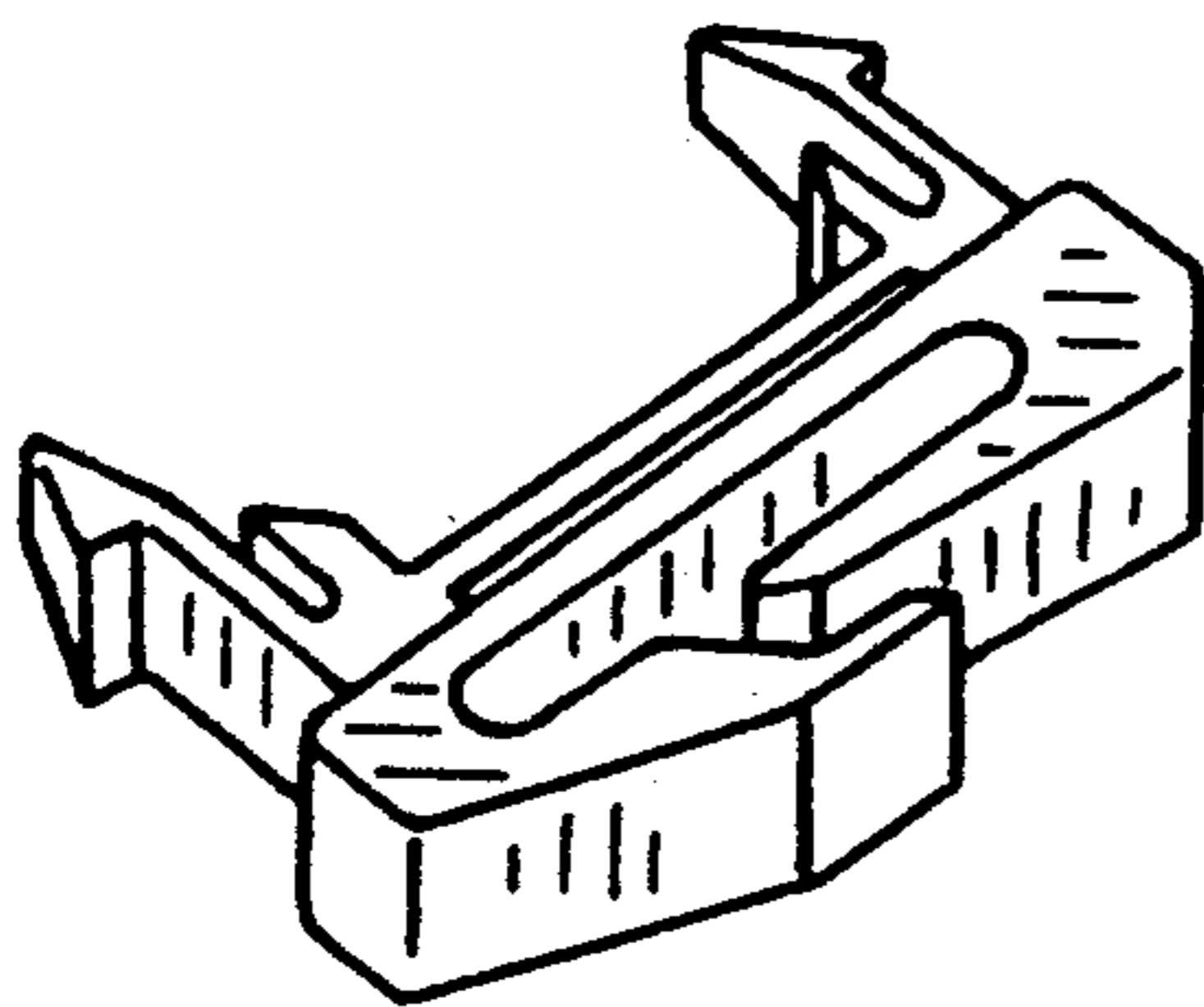

FIG. 1

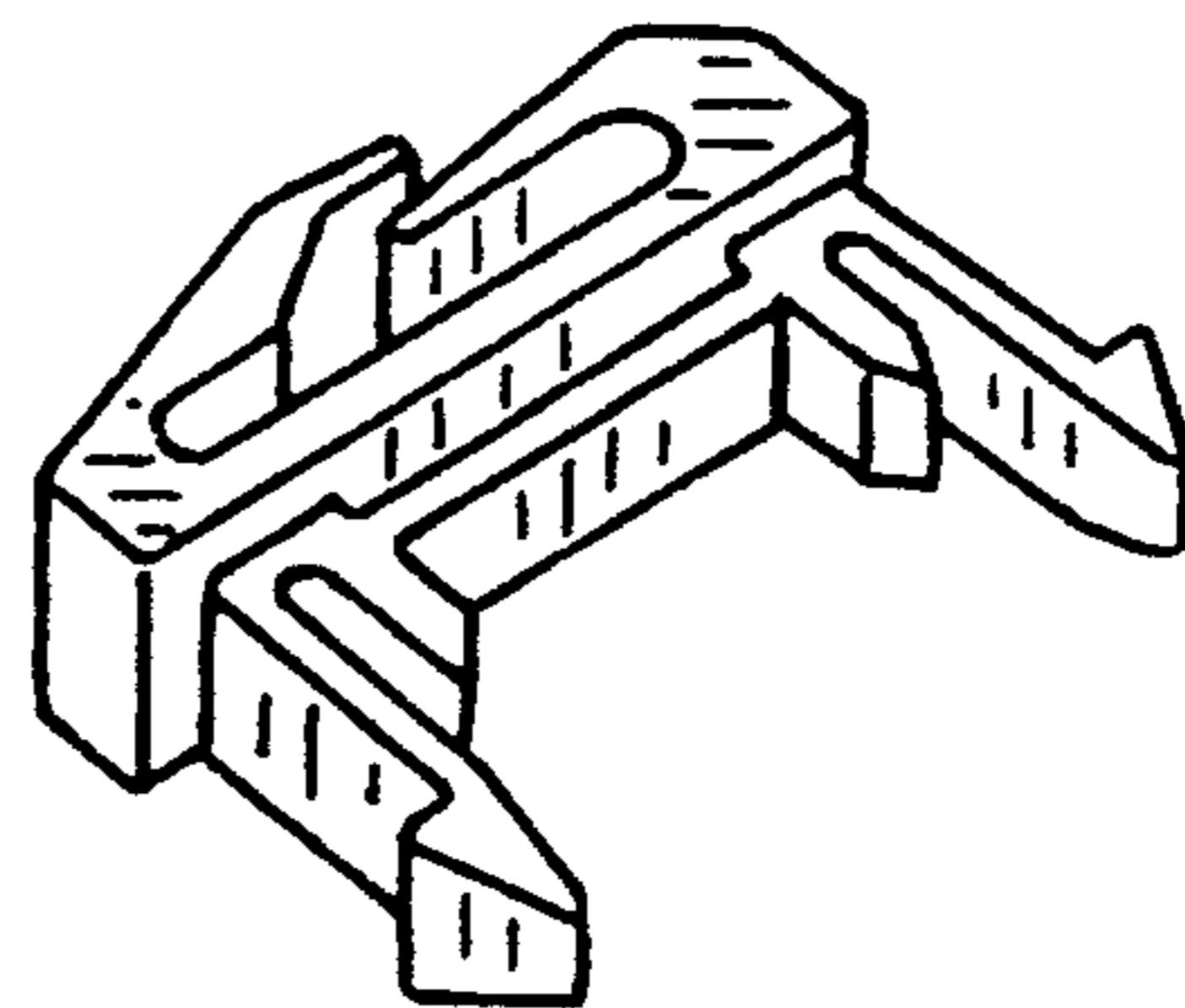

FIG. 2