



US00D335333S

United States Patent [19]

[11] Patent Number: **Des. 335,333**

Kohler, Jr. et al.

[45] Date of Patent: **** May 4, 1993**

[54] **COMBINED BATHTUB AND SPOUT**

[75] Inventors: **Herbert V. Kohler, Jr., Kohler; David J. O'Connell, Sturgeon Bay, both of Wis.**

[73] Assignee: **Kohler Co., Kohler, Wis.**

[**] Term: **14 Years**

[21] Appl. No.: **641,015**

[22] Filed: **Jan. 11, 1991**

[52] U.S. Cl. **D23/271; D23/281**

[58] Field of Search **D23/270, 271, 273, 275, D23/277-283, 303-307; D24/201-205; 4/538, 541.1-541.6, 557, 559, 560.1-566.1, 571.1-578.1, 584, 589, 590, 596, 610, 611, 612, 614, 621, 622, 675**

[56] **References Cited**

U.S. PATENT DOCUMENTS

D. 211,789	7/1968	Bonsack	D23/280
D. 226,607	4/1973	Lawrence	D23/281
D. 241,643	9/1976	Bonsack	D23/281
D. 274,454	6/1984	Robinson	D23/281
D. 279,702	7/1985	Harrison	D23/280
D. 286,679	11/1986	D'Innocente et al.	D23/281 X
D. 311,710	10/1990	Sauter et al.	D23/277
D. 313,838	1/1991	Lenahan	D23/277
372,347	11/1887	Wells .	
493,194	3/1893	Stifel et al. .	
755,109	3/1904	Bussenius .	
920,575	5/1909	Ike .	
1,436,538	11/1922	Schiller .	
4,912,782	4/1990	Robbins .	

OTHER PUBLICATIONS

Page 6-5, 1989 Kohler Co. K-900 catalog, showing "Pillow Talk" tub.

Primary Examiner—James R. Largen
Attorney, Agent, or Firm—Quarles & Brady

[57] **CLAIM**

The ornamental design for a combined bathtub and spout, as shown and described.

DESCRIPTION

FIG. 1 is a perspective view taken from the top, front and left side of a combined bathtub and spout showing our new design;

FIG. 2 is a top plan view thereof;

FIG. 3 is a cross-sectional view taken on line 3—3 of FIG. 2;

FIG. 4 is a cross-sectional view taken on line 4—4 of FIG. 2 with the spout shown in full for clarity;

FIG. 5 is a cross-sectional view taken on line 5—5 of FIG. 2 with the spout shown in full for clarity;

FIG. 6 is a detailed top frontal and right side perspective view of the spout shroud portions of the design;

FIG. 7 is a top plan view thereof;

FIG. 8 is a front elevational view thereof;

FIG. 9 is a bottom plan view thereof; and,

FIG. 10 is a right side elevational view thereof, the left side elevational view thereof being the mirror image thereof.

The fragmentary broken line representation of a deck in FIG. 1 is for purposes of illustration only and forms no part of the claimed design.

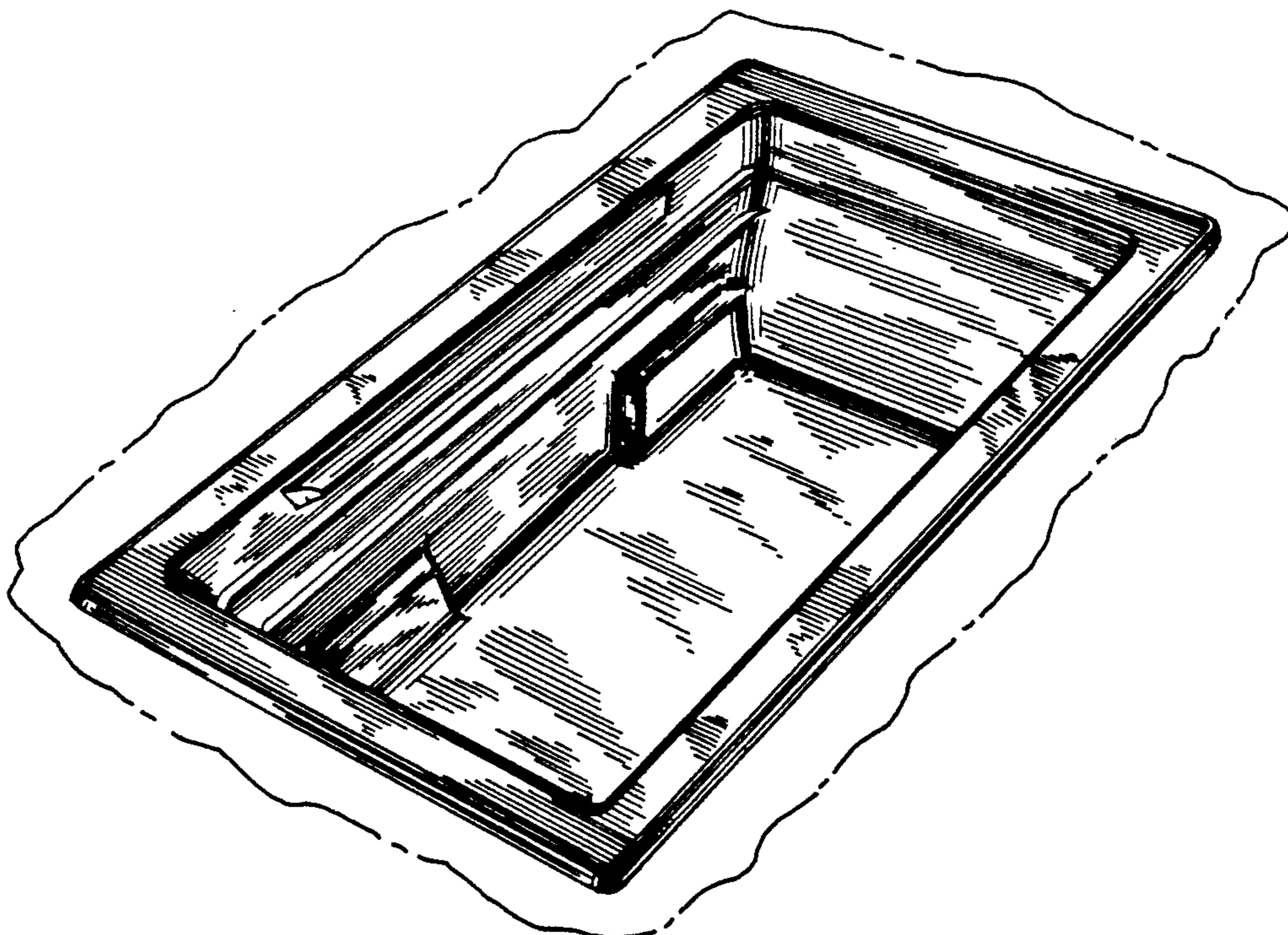

FIG. 1

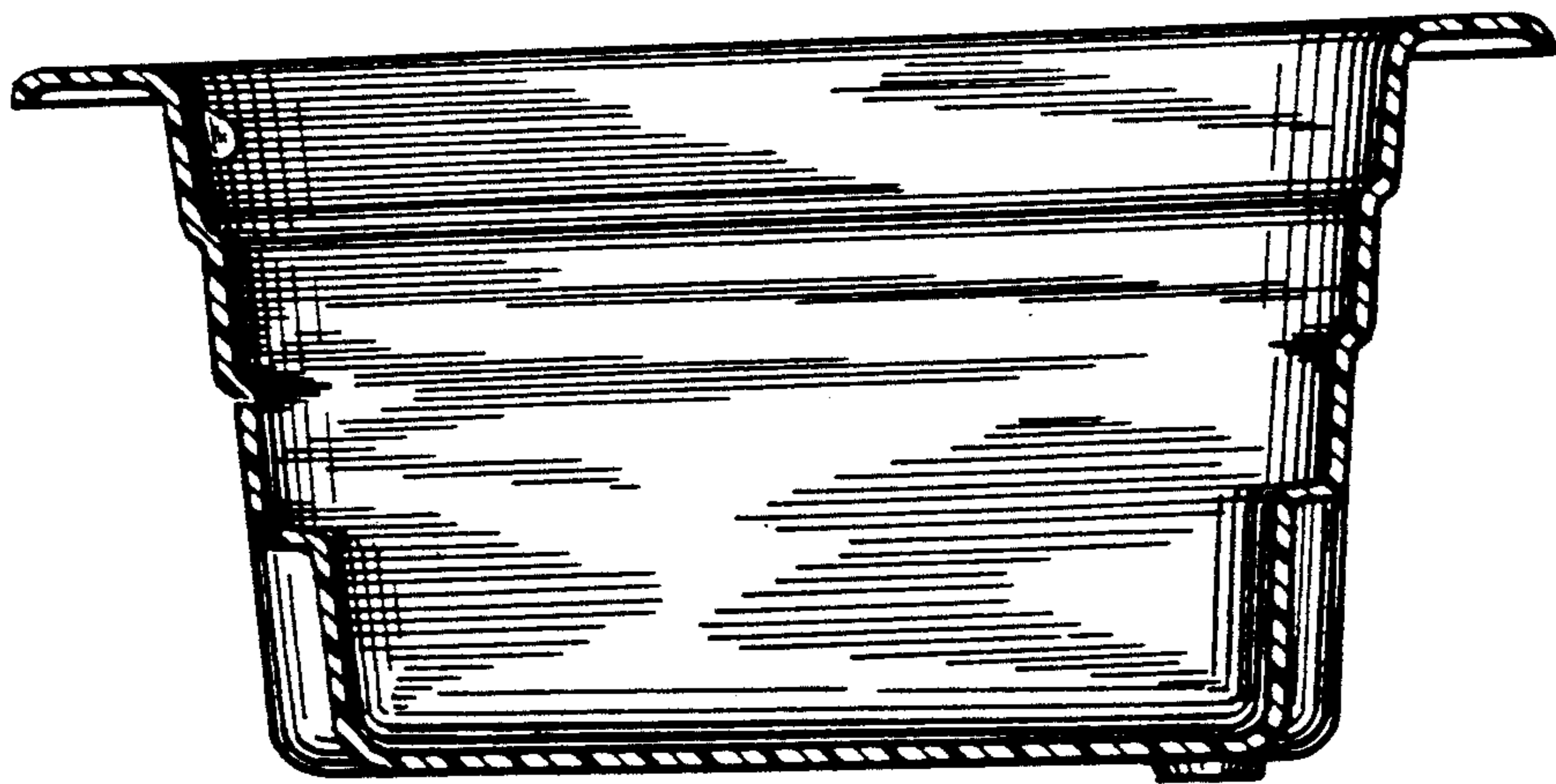
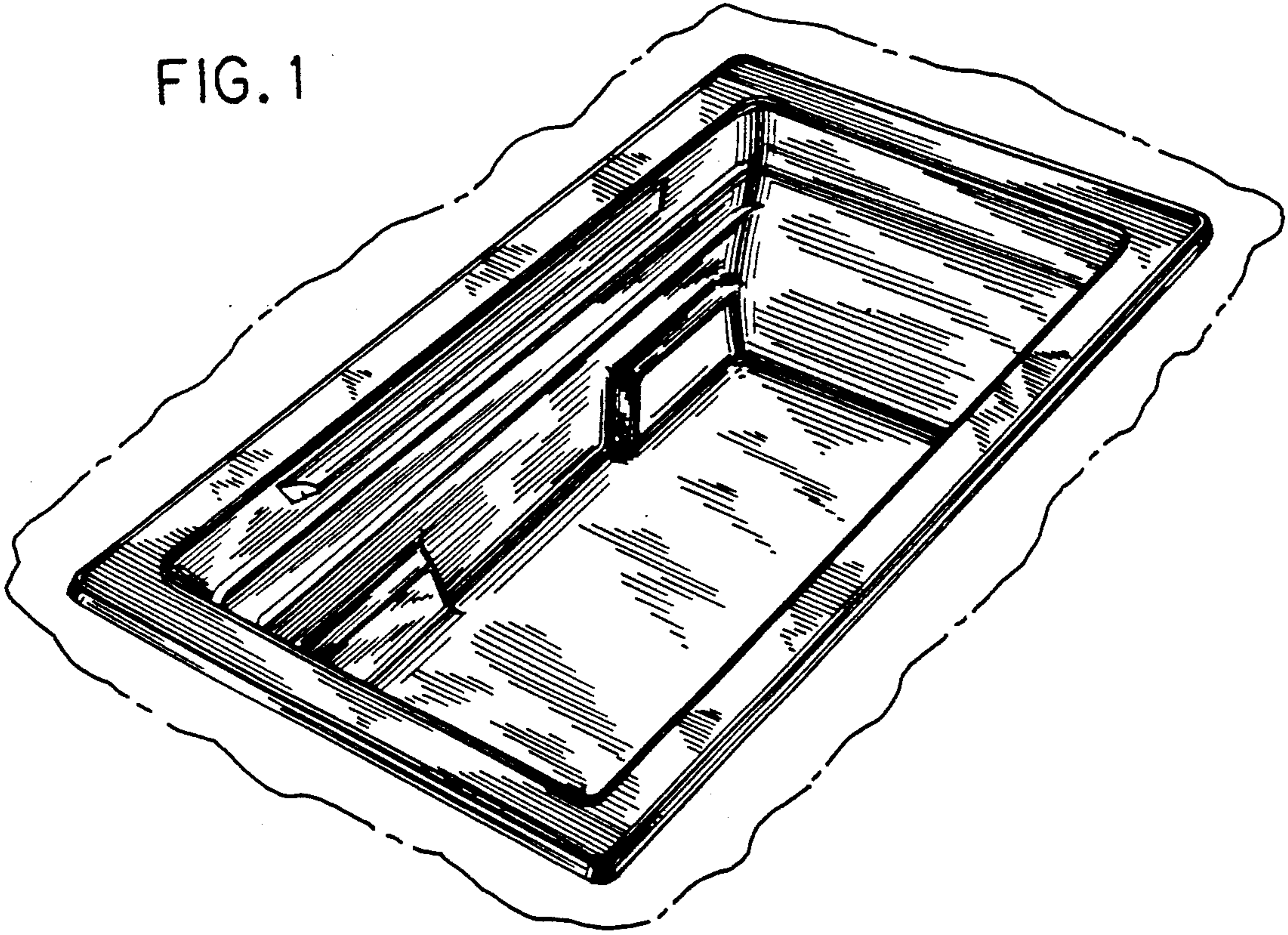

FIG. 5

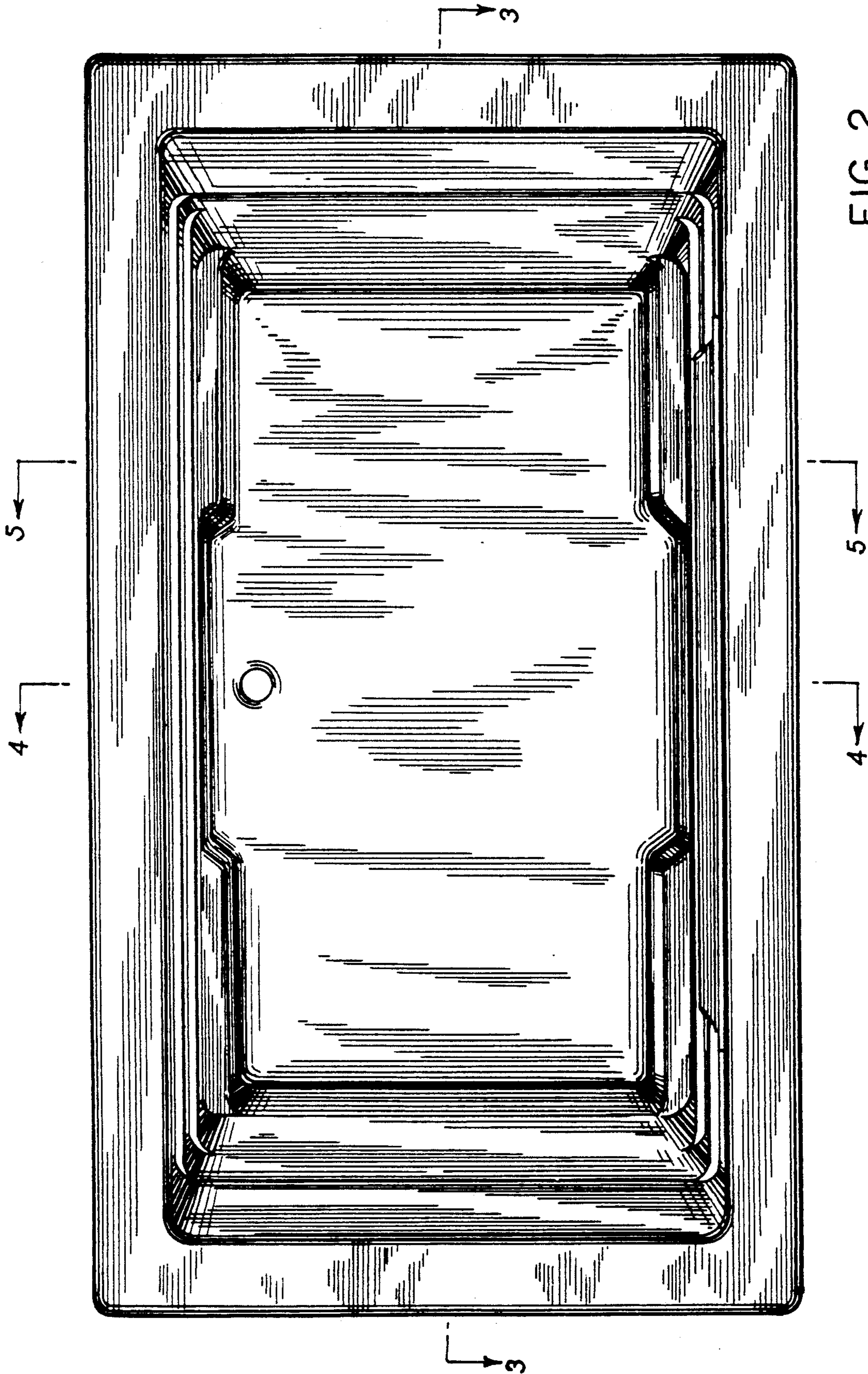

FIG. 2

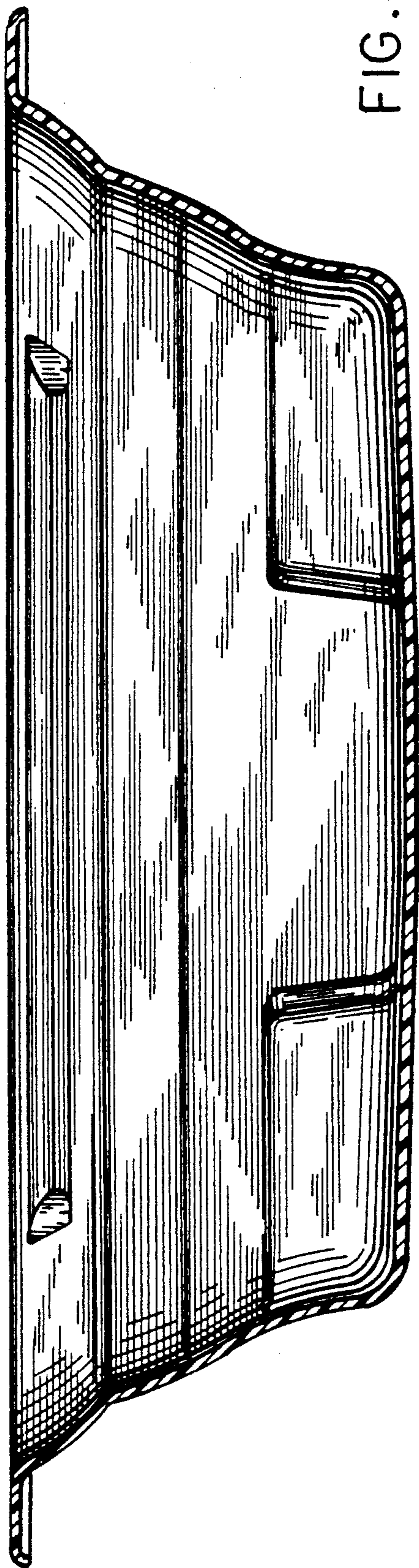

FIG. 3

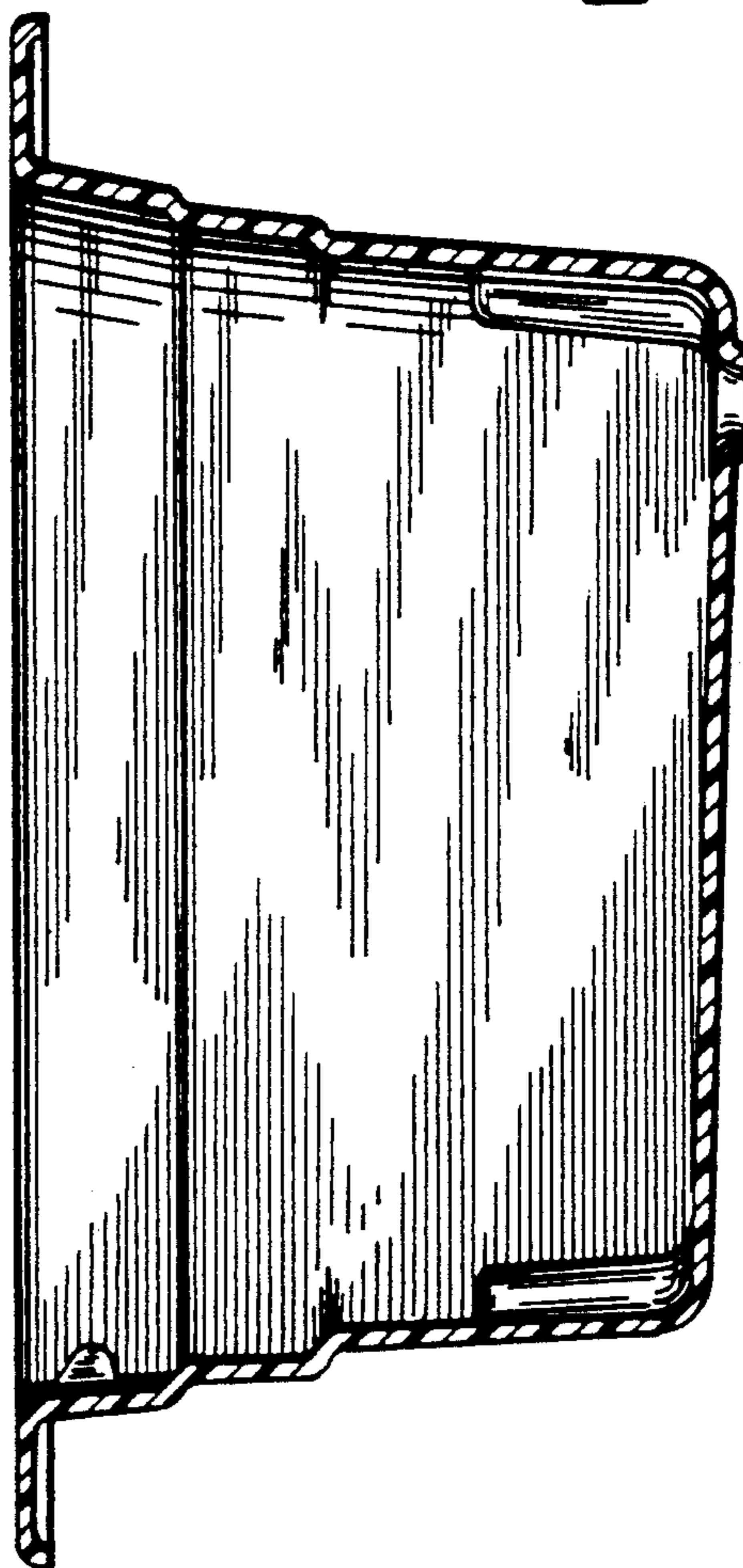

FIG. 4

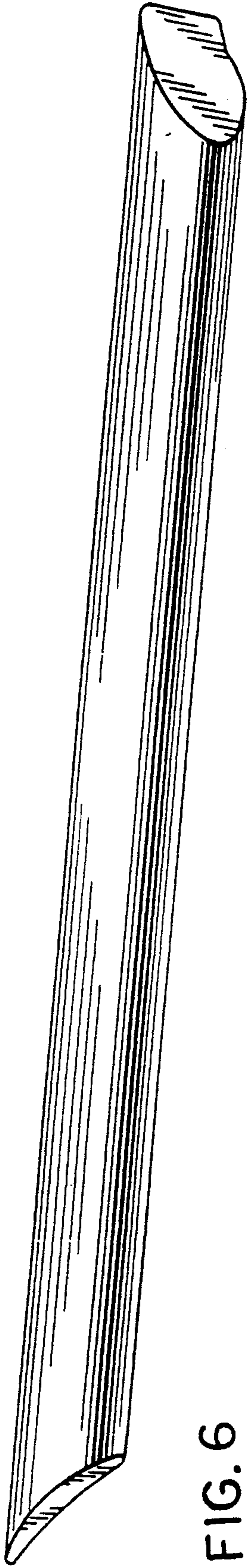

FIG. 6



FIG. 7



FIG. 8



FIG. 9



FIG. 10