



US00D335179S

United States Patent [19]

[11] Patent Number: **Des. 335,179**

Jones et al.

[45] Date of Patent: **** Apr. 27, 1993**

[54] SPECIMEN CUP HOLDER

[76] Inventors: **Timothy B. Jones**, 3030 SW. 89th, Apt. #E, Oklahoma City, Okla. 73159; **Robert D. Jones; Lori D. Jones**, both of 1452 N. Washington, Ardmore, Okla. 73401

[**] Term: **14 Years**

[21] Appl. No.: **770,658**

[22] Filed: **Oct. 3, 1991**

[52] U.S. Cl. **D24/128; D7/620; D24/227**

[58] Field of Search **D24/121, 122, 123, 227, D24/228, 128; D1/123, 124; D7/611, 620; 126/82; 240/311.2, 315; 246/15, 16, 20, 21; 24/17 AP, 305 R, 305 D; 128/760, 761, 763**

[56] References Cited

U.S. PATENT DOCUMENTS

D. 256,279	8/1980	Huggins	D7/620 X
D. 306,648	4/1990	Jones et al.	D24/128
2,628,054	2/1953	Faznkerly	248/311.2
4,244,920	1/1981	Manchot et al.	128/760 X
5,058,787	10/1991	Chou	248/312.1 X

OTHER PUBLICATIONS

The Lancet Publication Jan. 3, 1970, Fig. 2, Lower Right "Urinal Lid with Pommel Rack and forward placed cup", p. 22.

Primary Examiner—Stella Reid
Assistant Examiner—I. Simmons
Attorney, Agent, or Firm—Glen M. Burdick

[57] CLAIM

The ornamental design for a specimen cup holder, as shown and described.

DESCRIPTION

FIG. 1 is a perspective view of a specimen cup holder showing our new design, with a specimen cup in broken lines for illustrative purposes only and forming no part of the claimed design;

FIG. 2 is a rear elevational view thereof;

FIG. 3 is a front elevational view thereof;

FIG. 4 is a side elevational view thereof;

FIG. 5 is a side elevational view thereof, opposite that shown in FIG. 4;

FIG. 6 is a top plan view thereof; and,

FIG. 7 is a bottom plan view thereof.

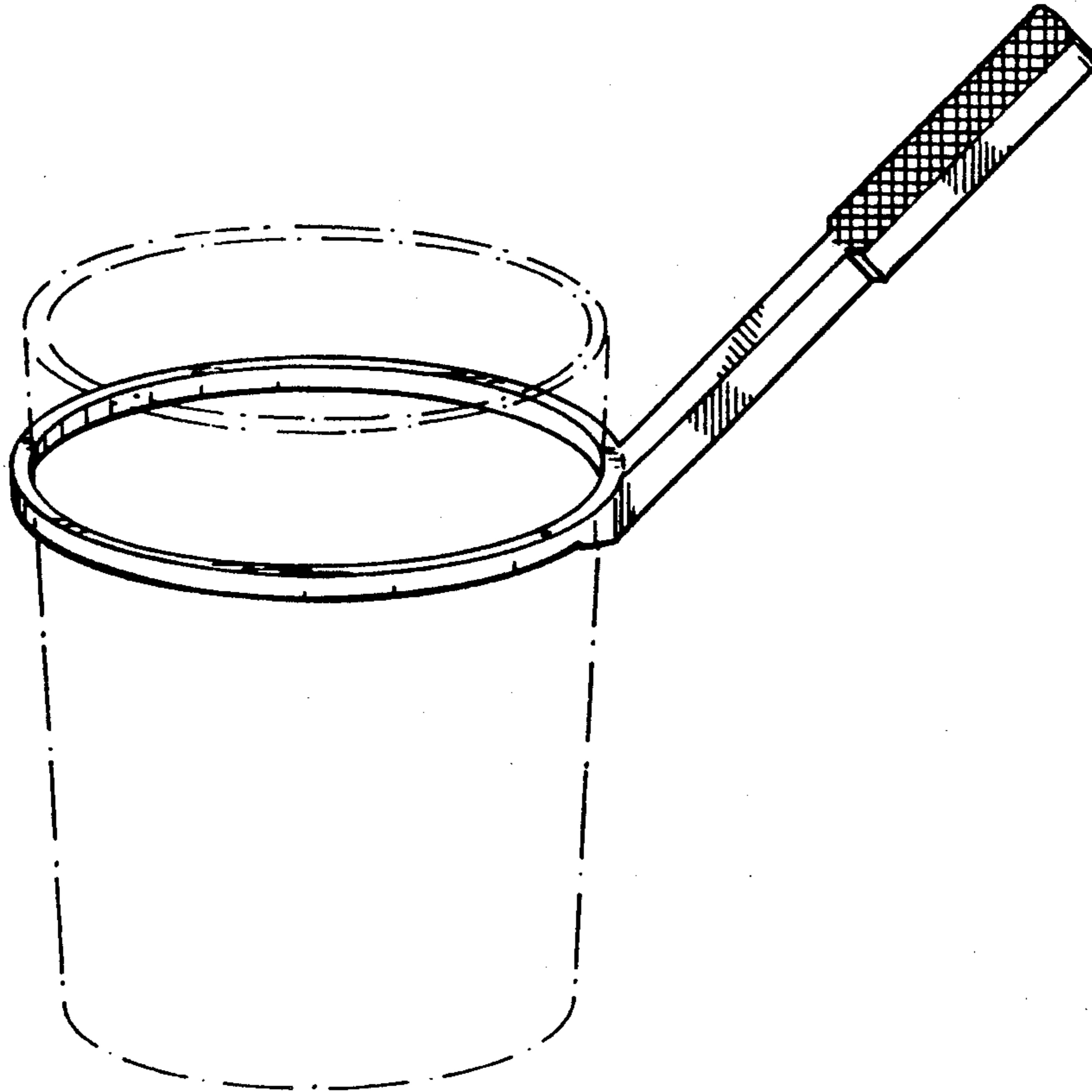

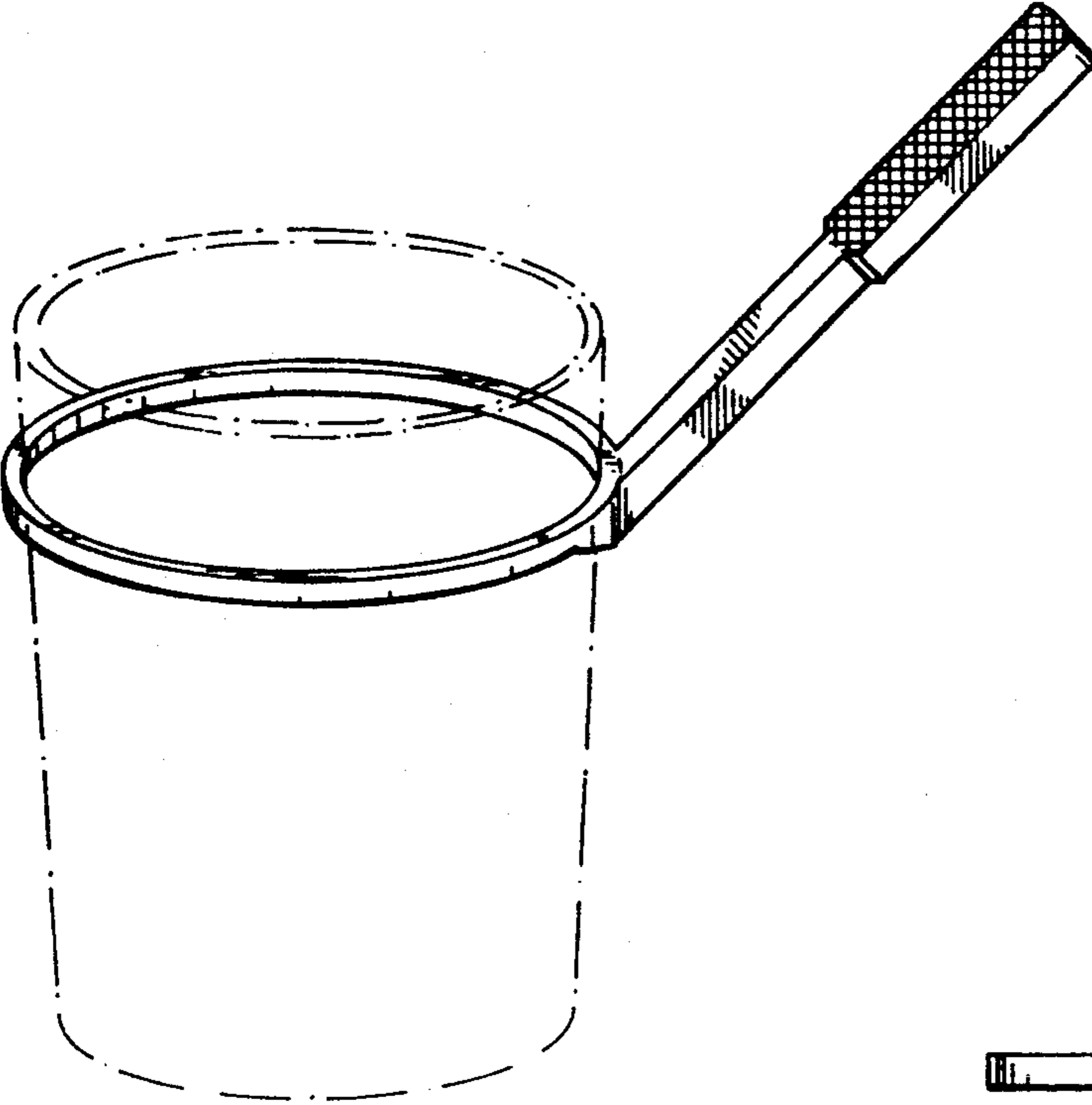

FIG. 1

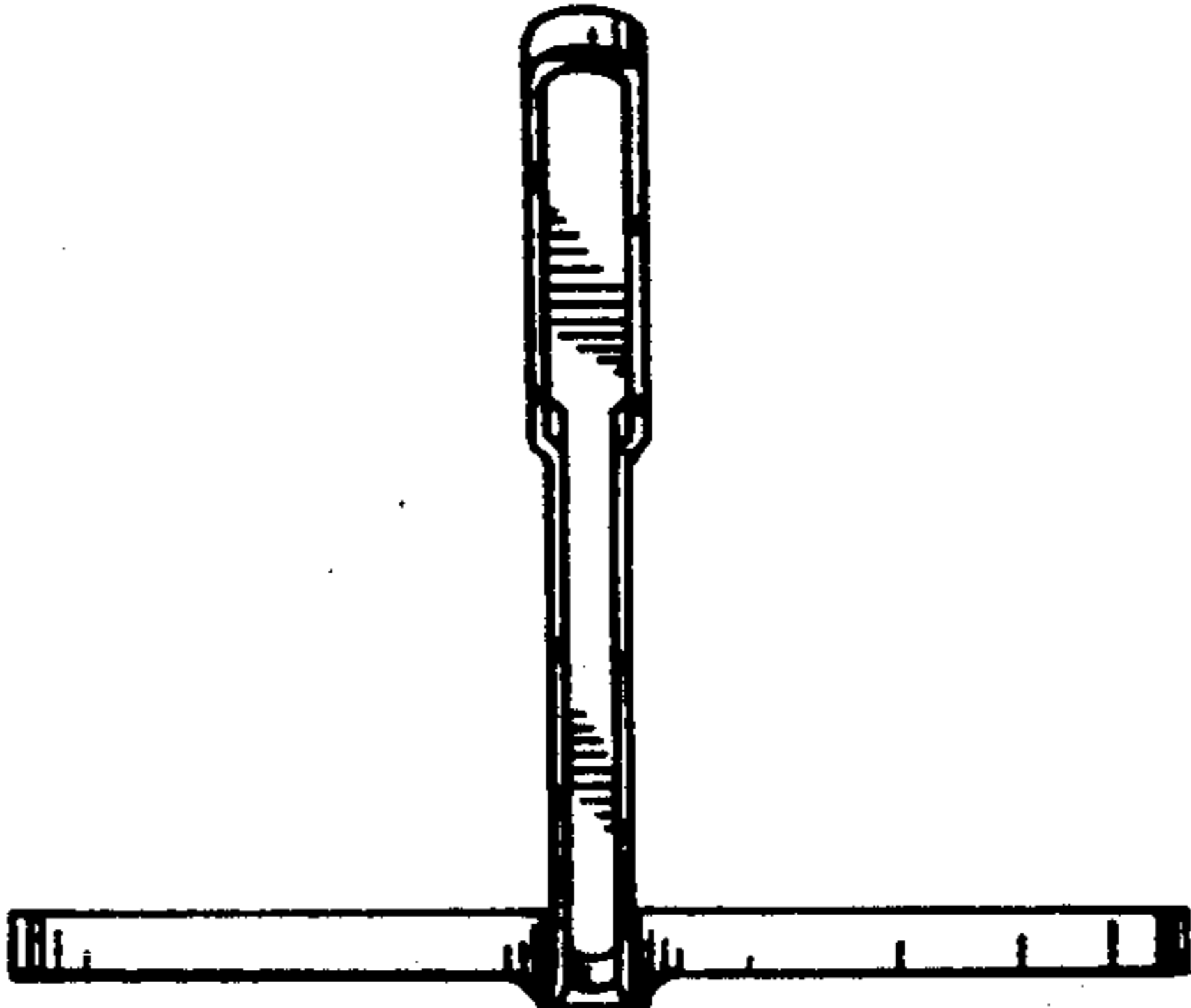

FIG. 2

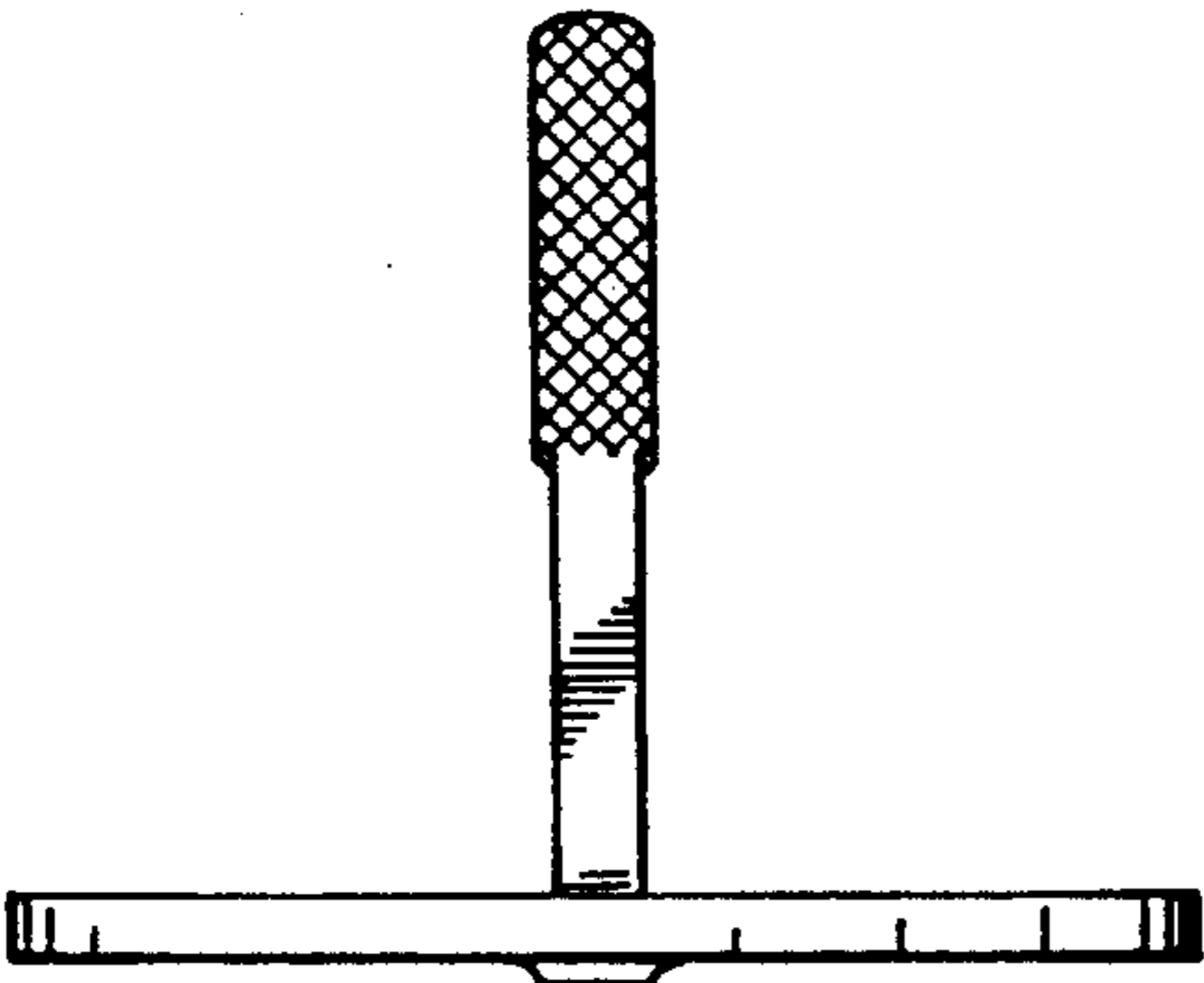

FIG. 3

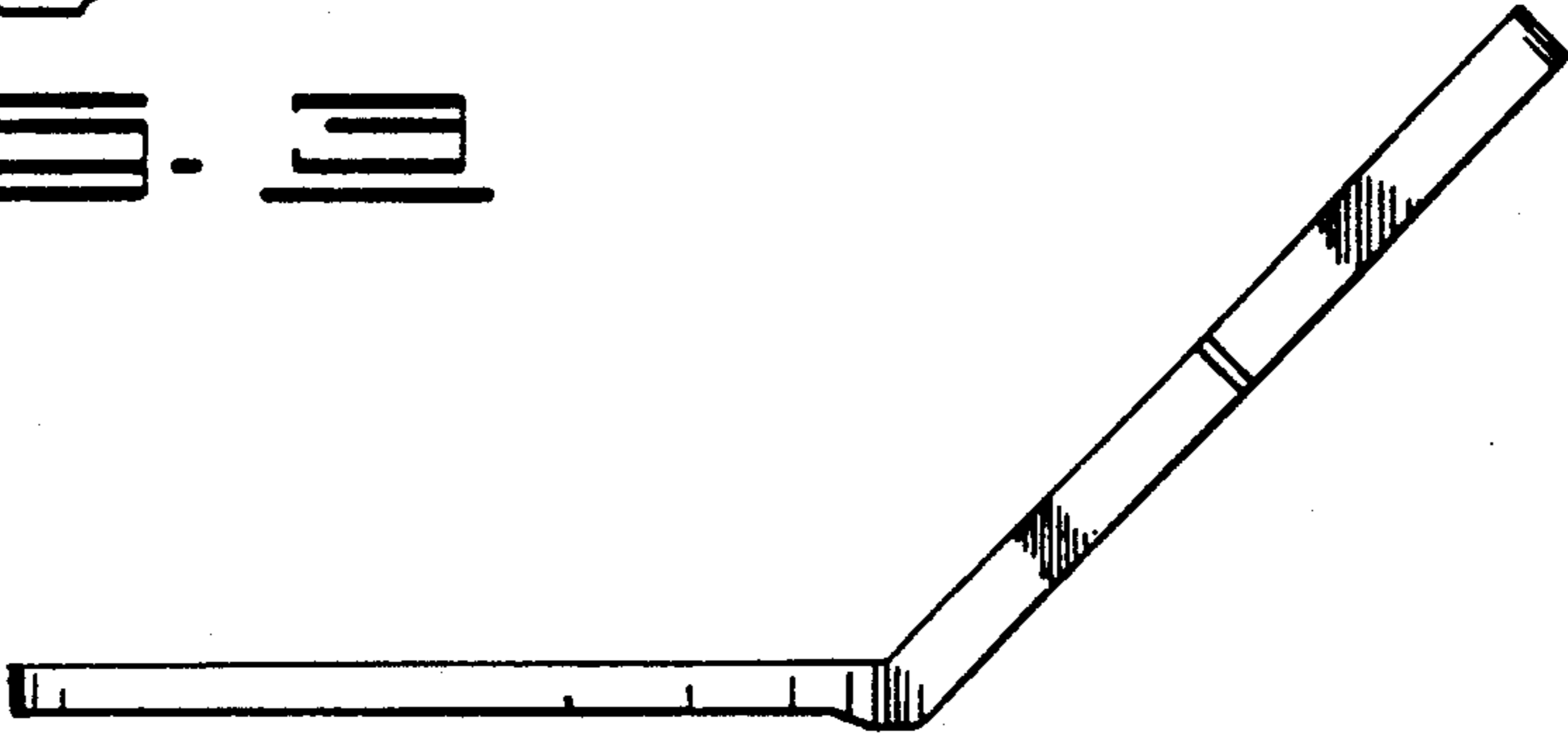

FIG. 4

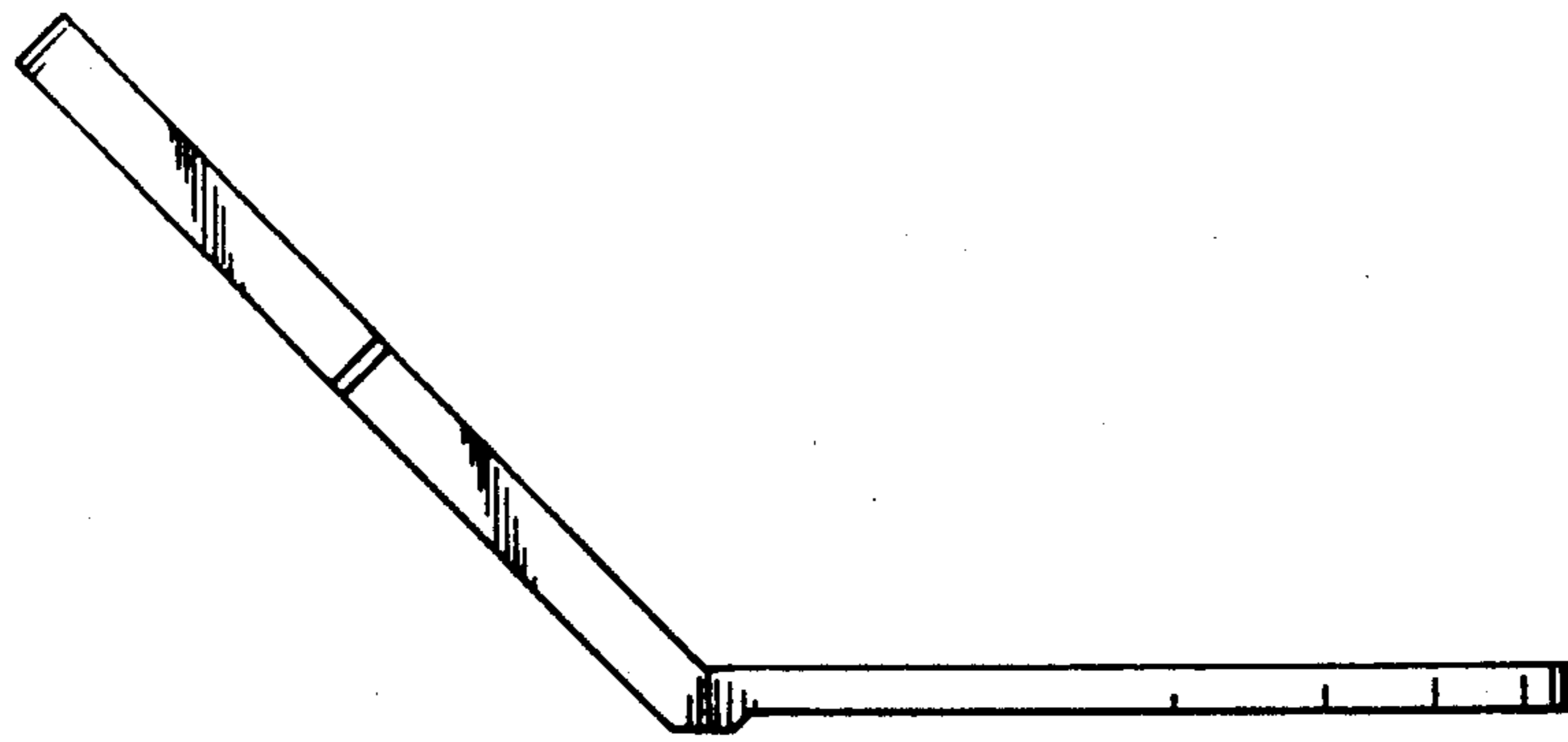

FIG. 5

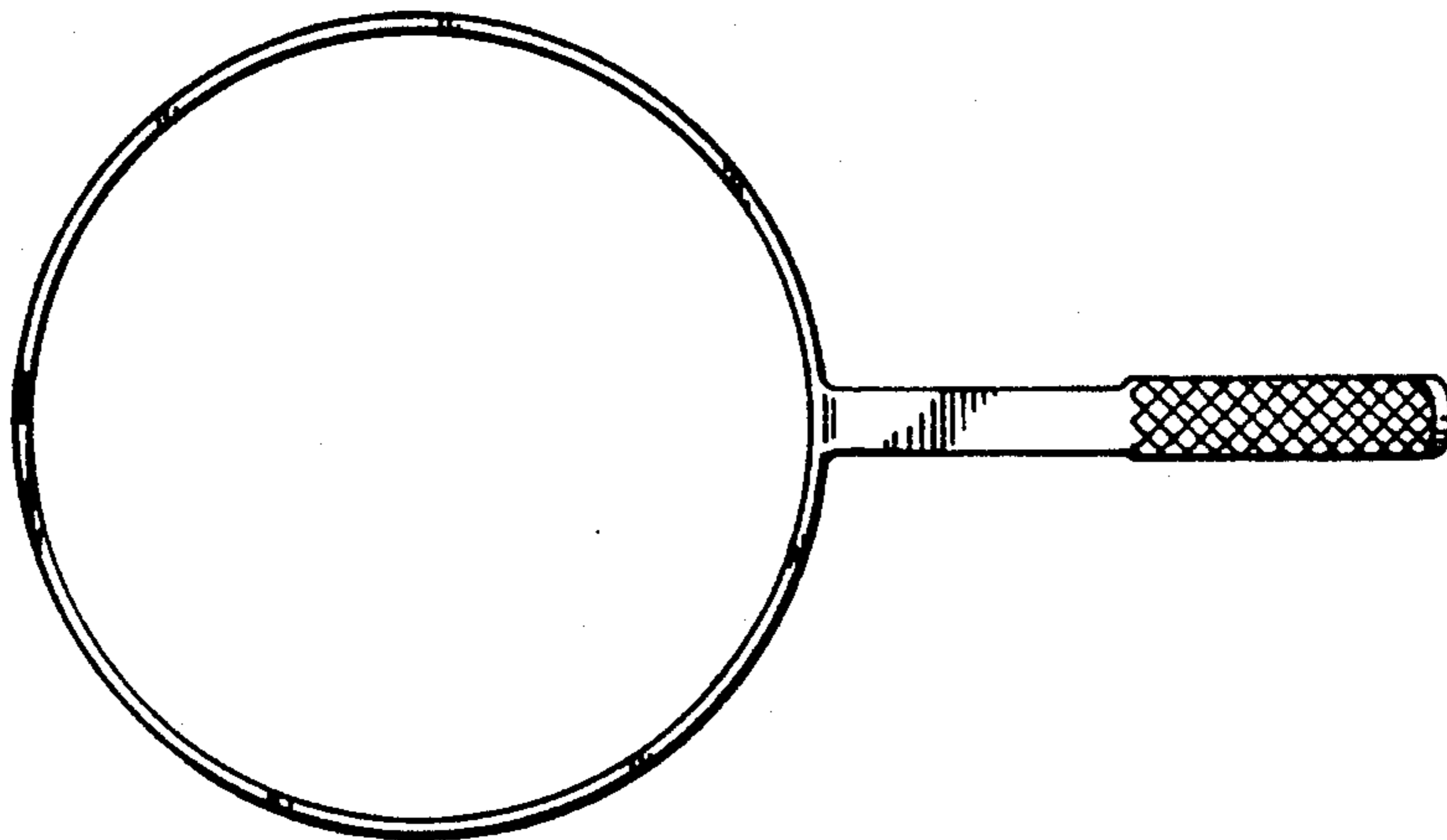

FIG. 6

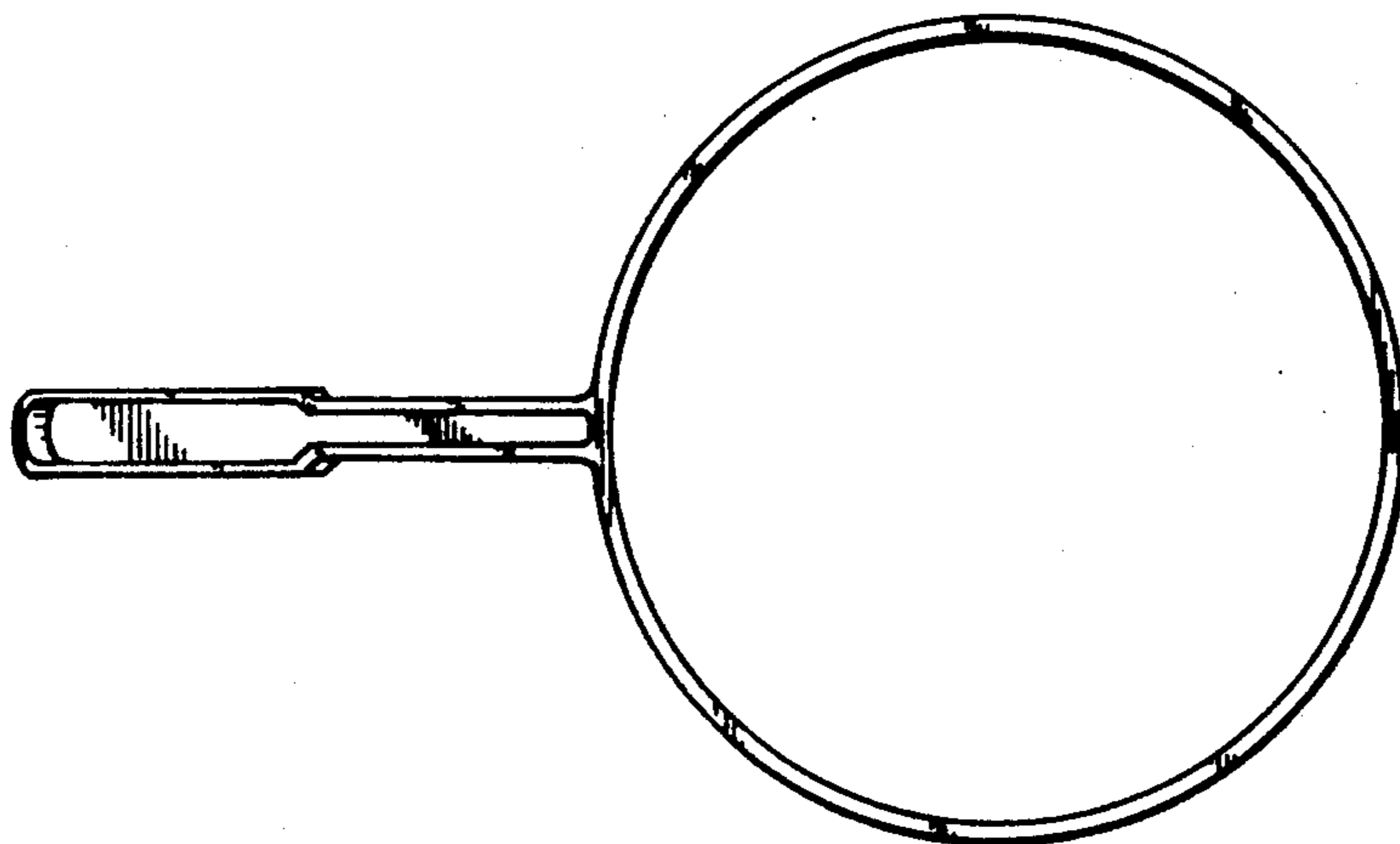

FIG. 7