



US00D335153S

# United States Patent [19]

Skov

[11] Patent Number: **Des. 335,153**

[45] Date of Patent: **\*\* Apr. 27, 1993**

[54] **ELEMENT FOR A TOY BUILDING SET**

[75] Inventor: **Ib T. Skov, Billund, Denmark**

[73] Assignee: **Interlego A.G., Baar, Switzerland**

[\*\*] Term: **14 Years**

[21] Appl. No.: **789,102**

[22] Filed: **Nov. 6, 1991**

[52] U.S. Cl. .... **D21/108**

[58] Field of Search ..... **D21/108, 124; 446/102, 446/103, 120, 124, 125, 128**

[56] **References Cited**

**U.S. PATENT DOCUMENTS**

- D. 295,645 5/1988 Knudsen ..... D21/108
- D. 304,468 11/1989 Dideriksen ..... D21/108
- D. 314,990 2/1991 Refsing ..... D21/108
- D. 315,754 3/1991 Eggert ..... D21/108

D. 317,480 6/1991 Skov ..... D21/108

*Primary Examiner*—Bernard Ansher

*Assistant Examiner*—R. Barkai

*Attorney, Agent, or Firm*—Kane, Dalsimer, Sullivan

Kurucz, Levy, Eisele and Sullivan

[57] **CLAIM**

The ornamental design for an element for a toy building set, as shown and described.

**DESCRIPTION**

FIG. 1 is a top perspective view of the element for a toy building set showing my new design;

FIG. 2 is a front elevational view thereof;

FIG. 3 is a side elevational view thereof, the other side being identical;

FIG. 4 is a rear elevational view thereof;

FIG. 5 is a top plan view thereof; and,

FIG. 6 is a bottom plan view thereof.

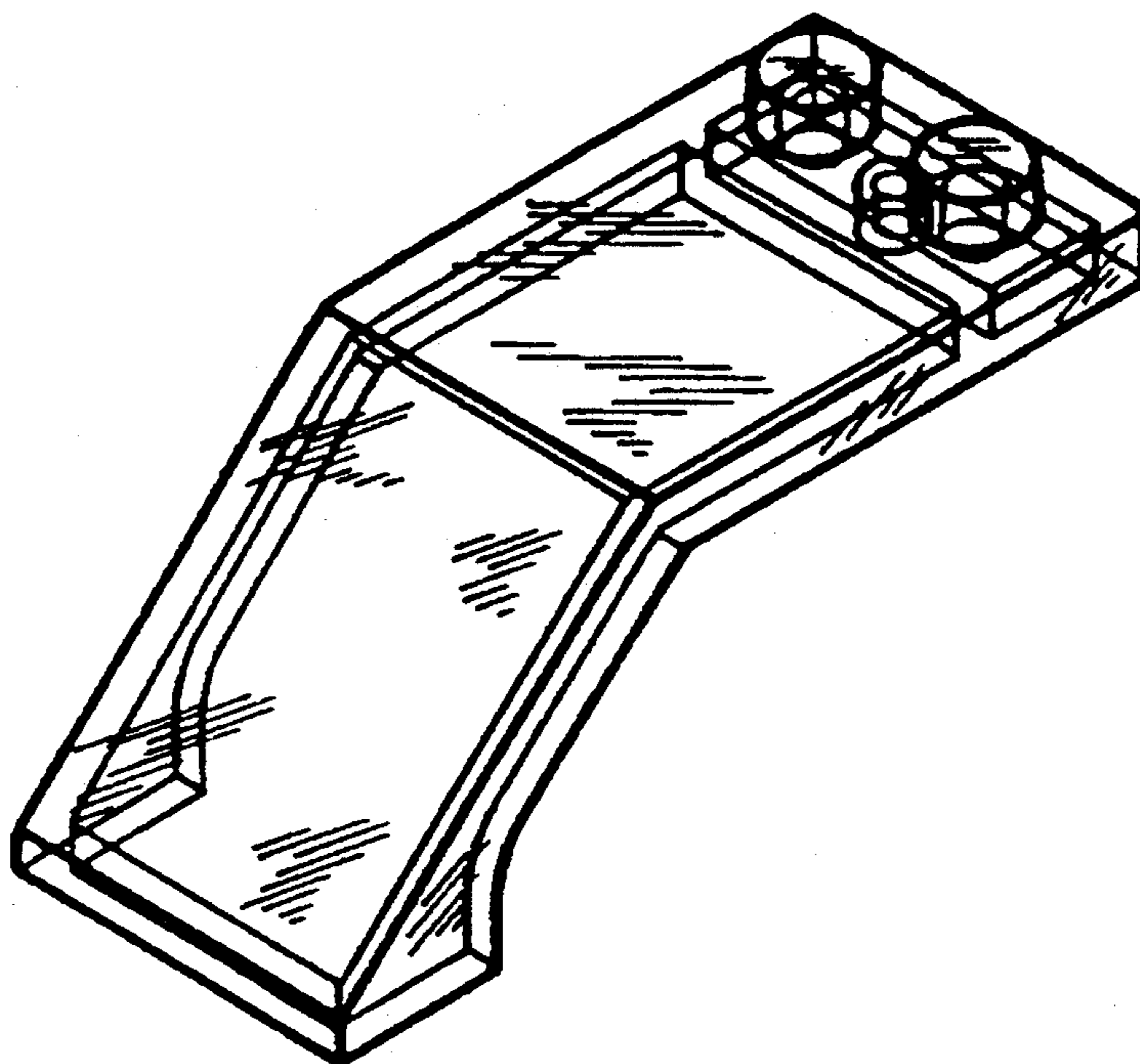

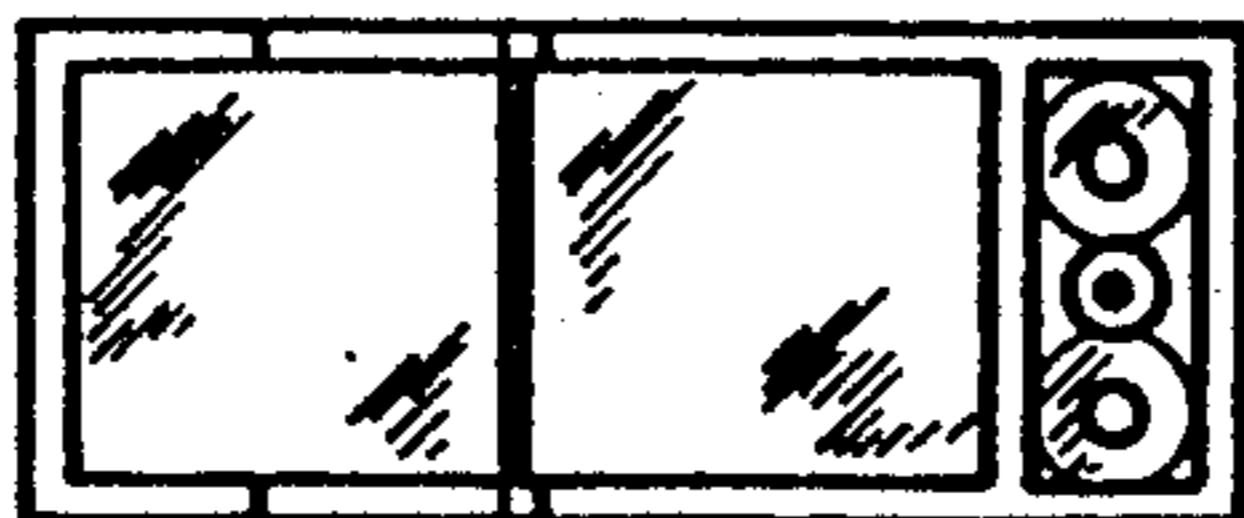

FIG. 6

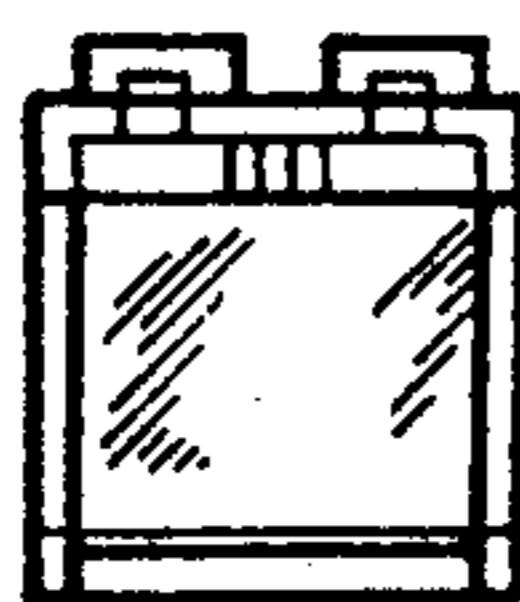

FIG. 4

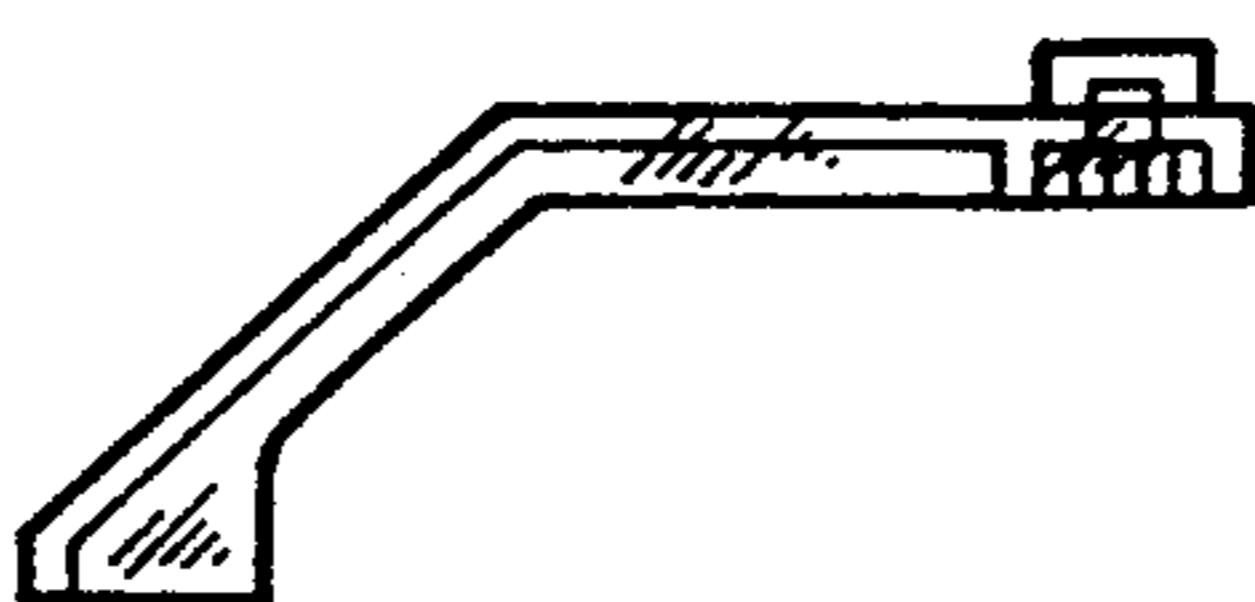

FIG. 3

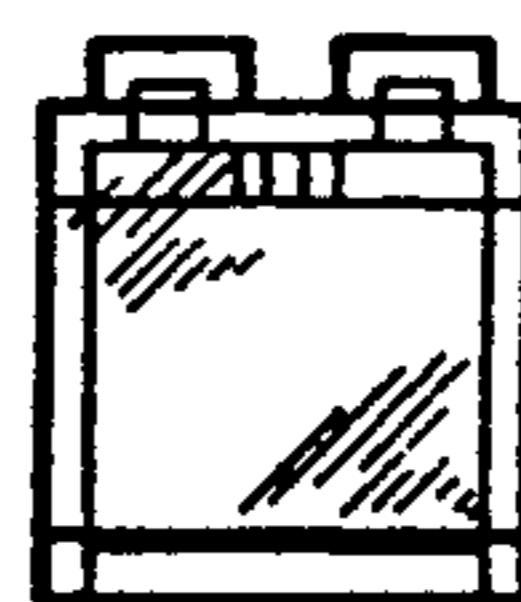

FIG. 2

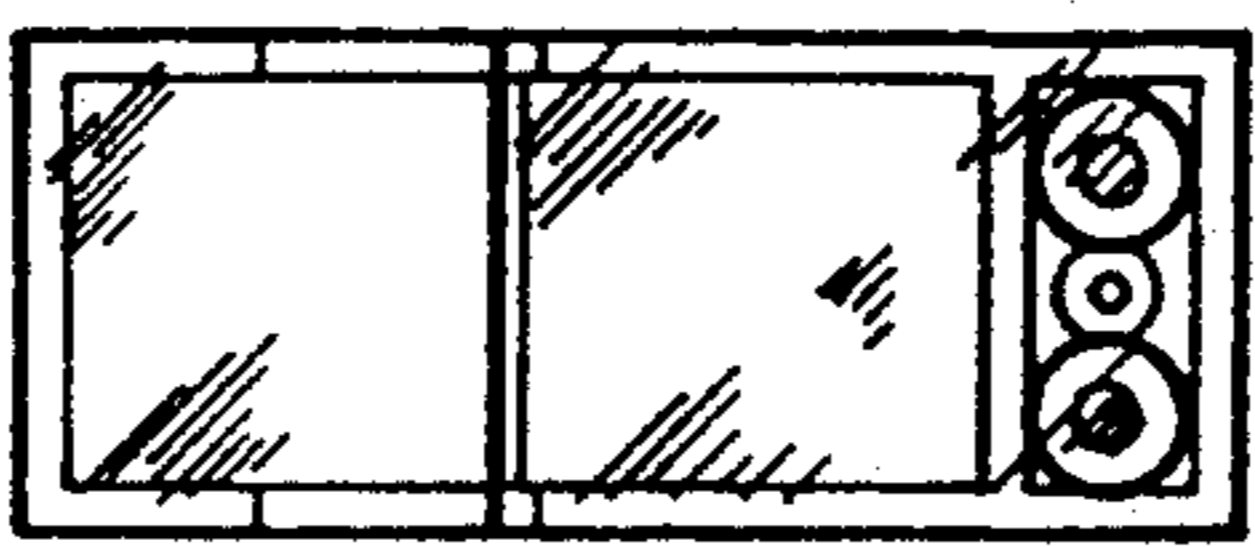

FIG. 5

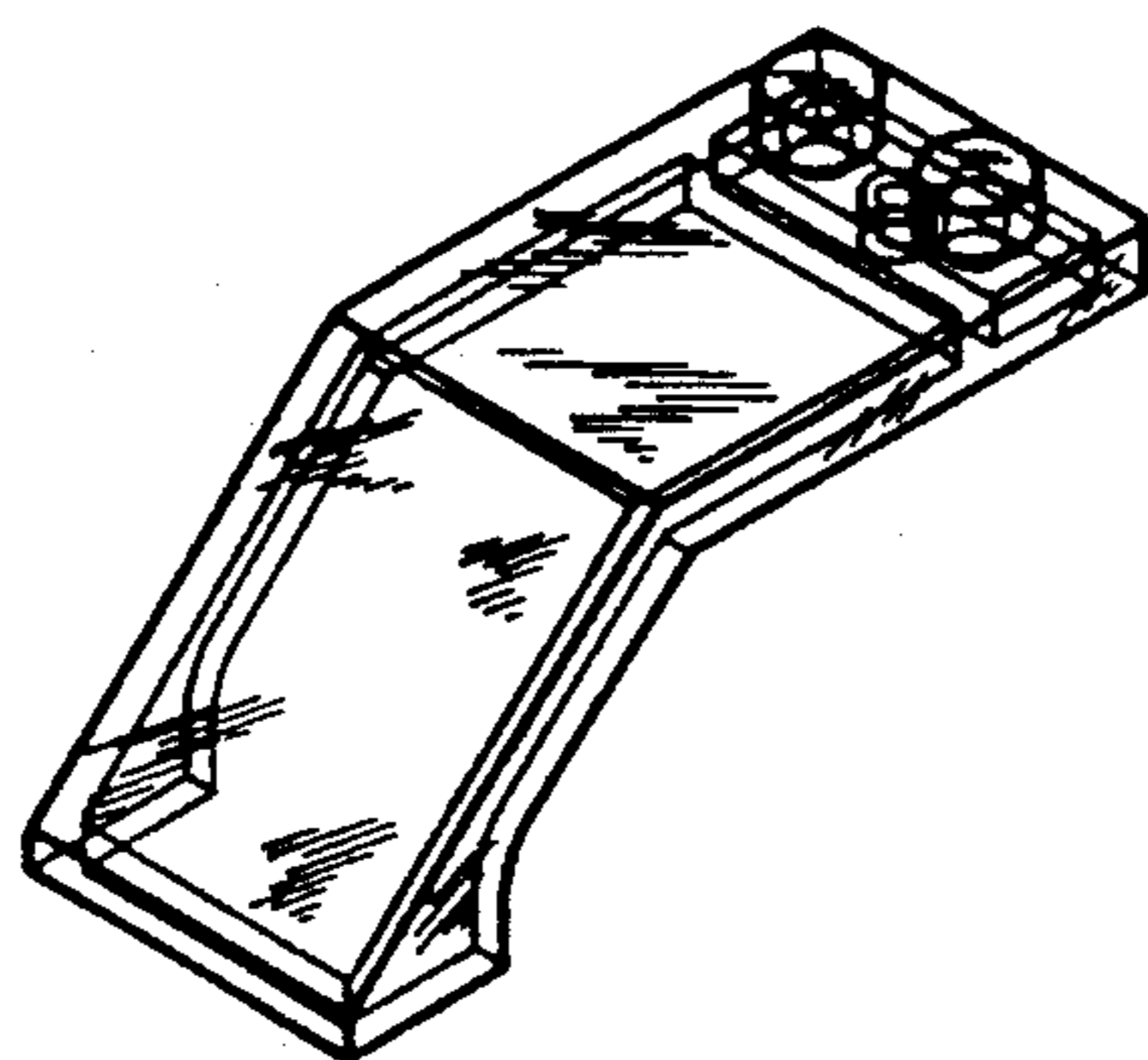

FIG. 1