



US00D334973S

United States Patent [19]

[11] Patent Number: **Des. 334,973**

Valentine et al.

[45] Date of Patent: **** Apr. 20, 1993**

[54] **SURGICAL INSTRUMENT HOLDING TRAY**

[75] Inventors: **A. H. Lynn Valentine, Granada Hills; Rudy Gaba, Simi Valley, both of Calif.**

[73] Assignee: **Devon Industries, Inc., Torrance, Calif.**

[**] Term: **14 Years**

[21] Appl. No.: **591,869**

[22] Filed: **Oct. 2, 1990**

[52] U.S. Cl. **D24/227; D24/229**

[58] Field of Search **D24/223, 227, 229; 206/53.5, 364, 366, 365, 363, 438, 562, 563, 564, 565**

3,770,119	11/1973	Hultberg et al. .
3,986,505	10/1976	Power .
4,042,109	8/1977	Barcan .
4,053,280	10/1977	Salisbury .
4,221,295	9/1980	Tuchband et al. .
4,241,833	12/1980	Luebeke .
4,483,455	11/1984	Prophet, Jr. et al. .
4,522,302	6/1985	Paikoff 206/571 X
4,523,679	6/1985	Paikoff et al. .
4,595,102	6/1986	Cianci et al. .
4,844,259	7/1989	Glowczewskie, Jr. et al. .
4,925,047	5/1990	Valentine et al. .

Primary Examiner—Stella Reid

Assistant Examiner—Ian Simmons

Attorney, Agent, or Firm—Poms, Smith, Lande & Rose

[57] CLAIM

The ornamental design for a surgical instrument holding tray, as shown and described.

DESCRIPTION

FIG. 1 is a front perspective view of a surgical instrument holding tray, showing our new design; FIG. 2 is a top plan view thereof; FIG. 3 is a side elevational view thereof, the opposite side elevational view being identical thereto; FIG. 4 is a front elevational view thereof; FIG. 5 is a rear elevational view thereof; FIG. 6 is a bottom plan view thereof; FIG. 7 is a cross-sectional view thereof, taken along line 7—7 of FIG. 2; and, FIG. 8 is a cross-sectional view thereof, taken along the line 8—8 of FIG. 2.

[56] References Cited

U.S. PATENT DOCUMENTS

D. 196,884	11/1963	Furlong, Jr.	D24/229 X
D. 199,379	10/1964	Taterka	D24/229
D. 218,077	7/1970	Gabriel	D24/229
D. 249,362	9/1978	Forsman et al.	D24/230
D. 262,824	1/1982	Dignan	D24/229
D. 293,469	12/1987	Greenblatt	D24/229
2,613,517	10/1952	Frantz .	
2,626,737	1/1953	Pitz .	
2,932,437	4/1960	Wilcox .	
3,095,088	6/1963	Blaikie et al. .	
3,385,465	5/1968	Bliss .	
3,537,446	11/1970	Rowland, Jr. .	
3,542,019	11/1970	Gittins .	

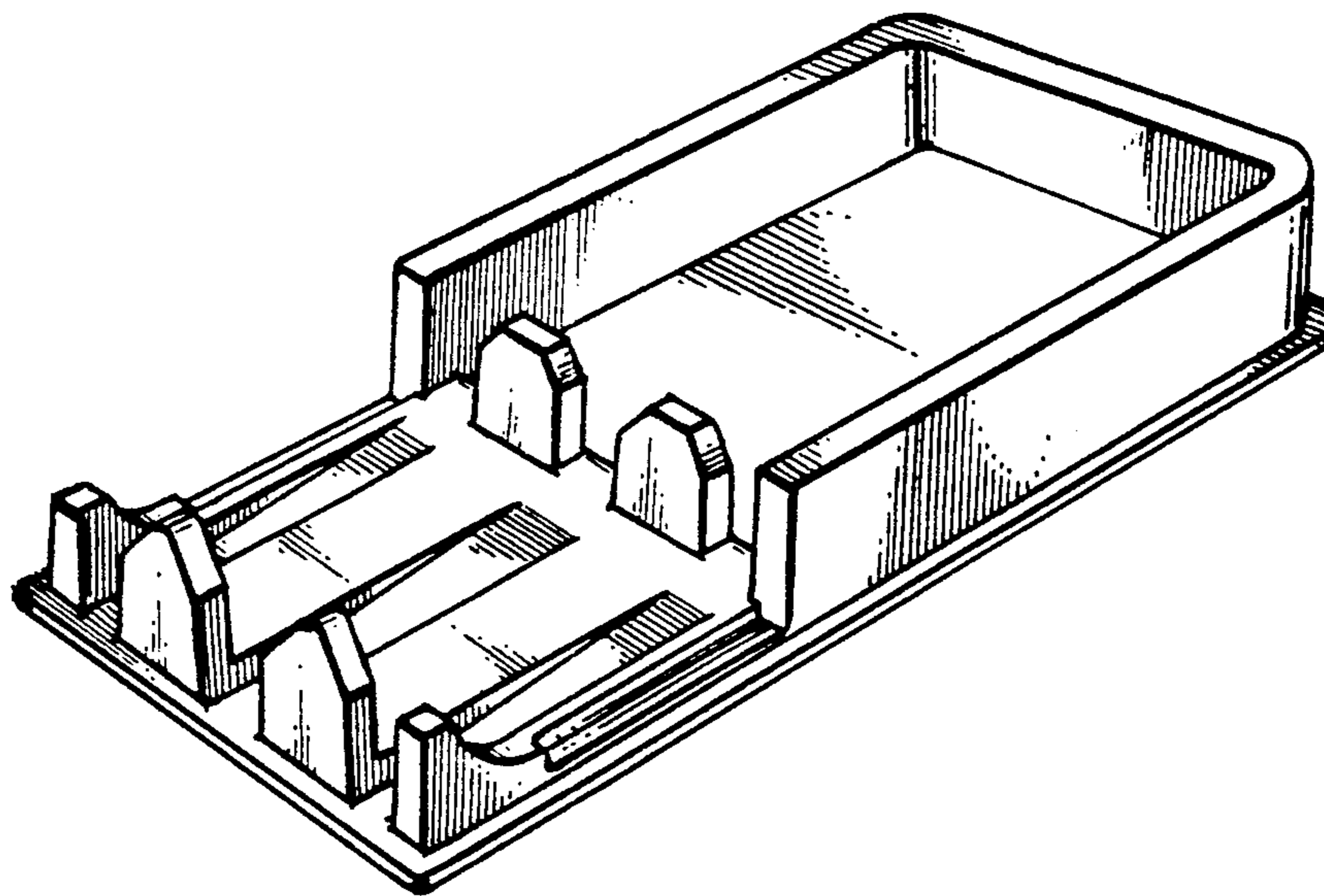

Fig. 1.

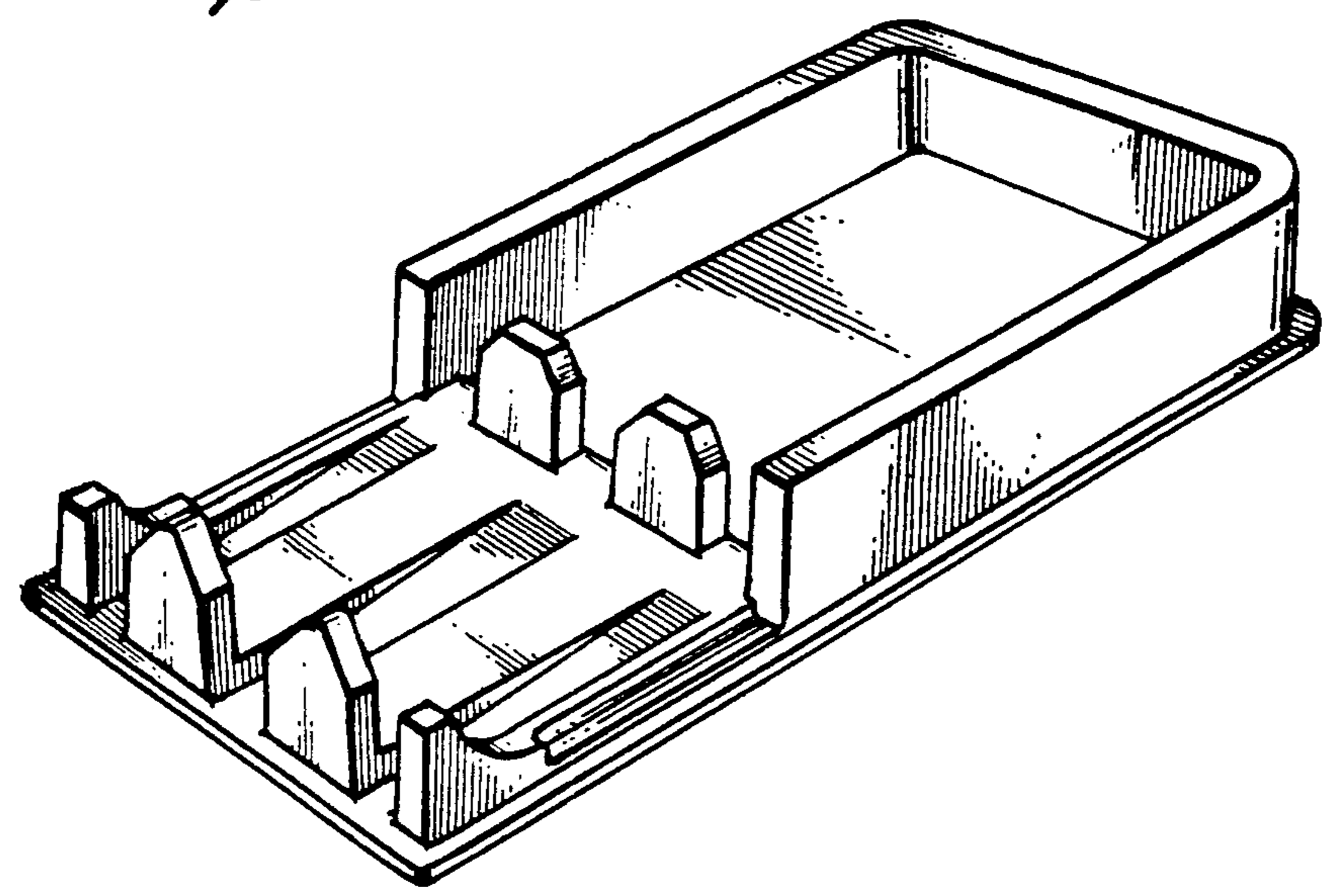
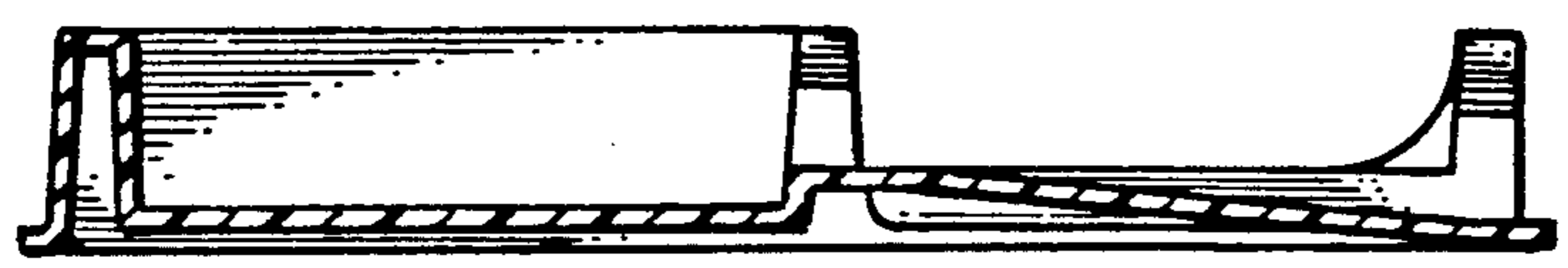

Fig. 7.



Fig. 8.



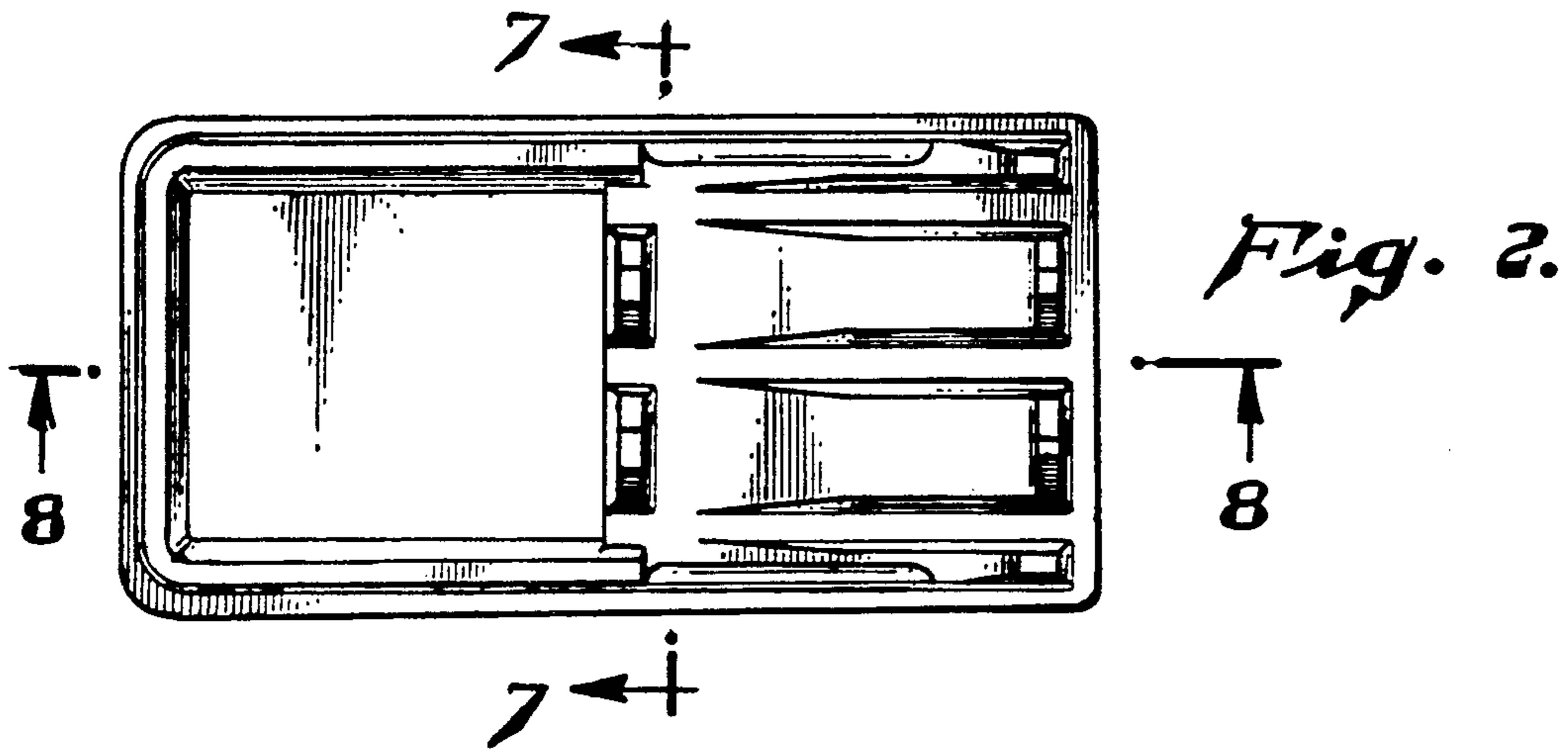

Fig. 4.



Fig. 3.

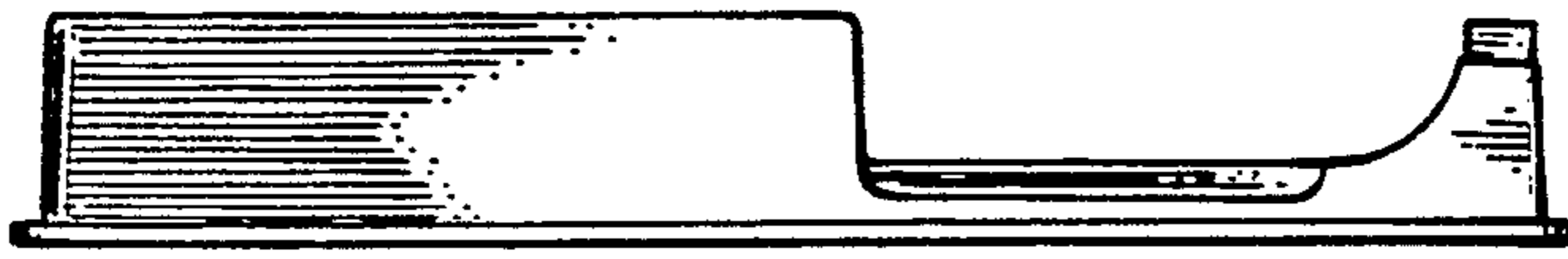

Fig. 5.

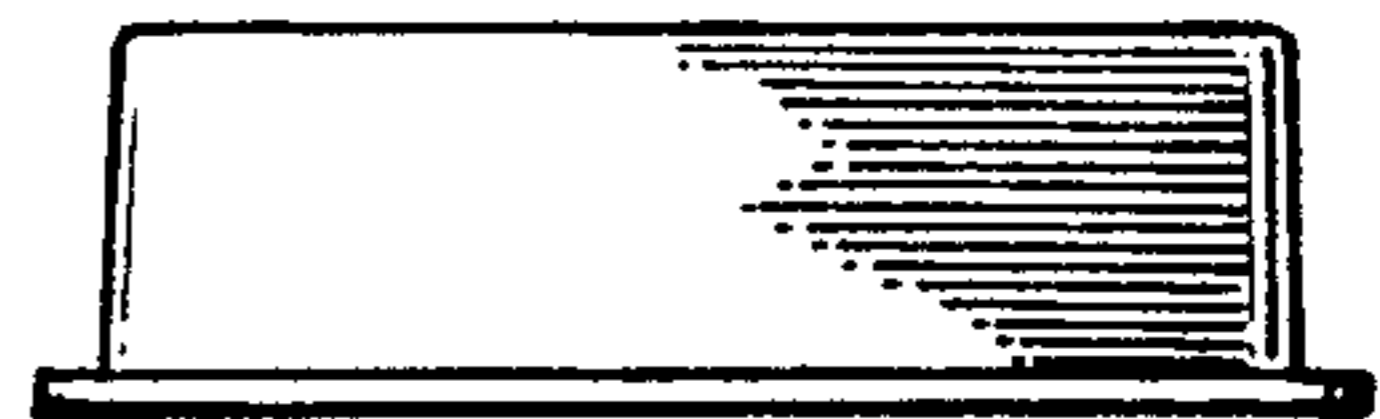
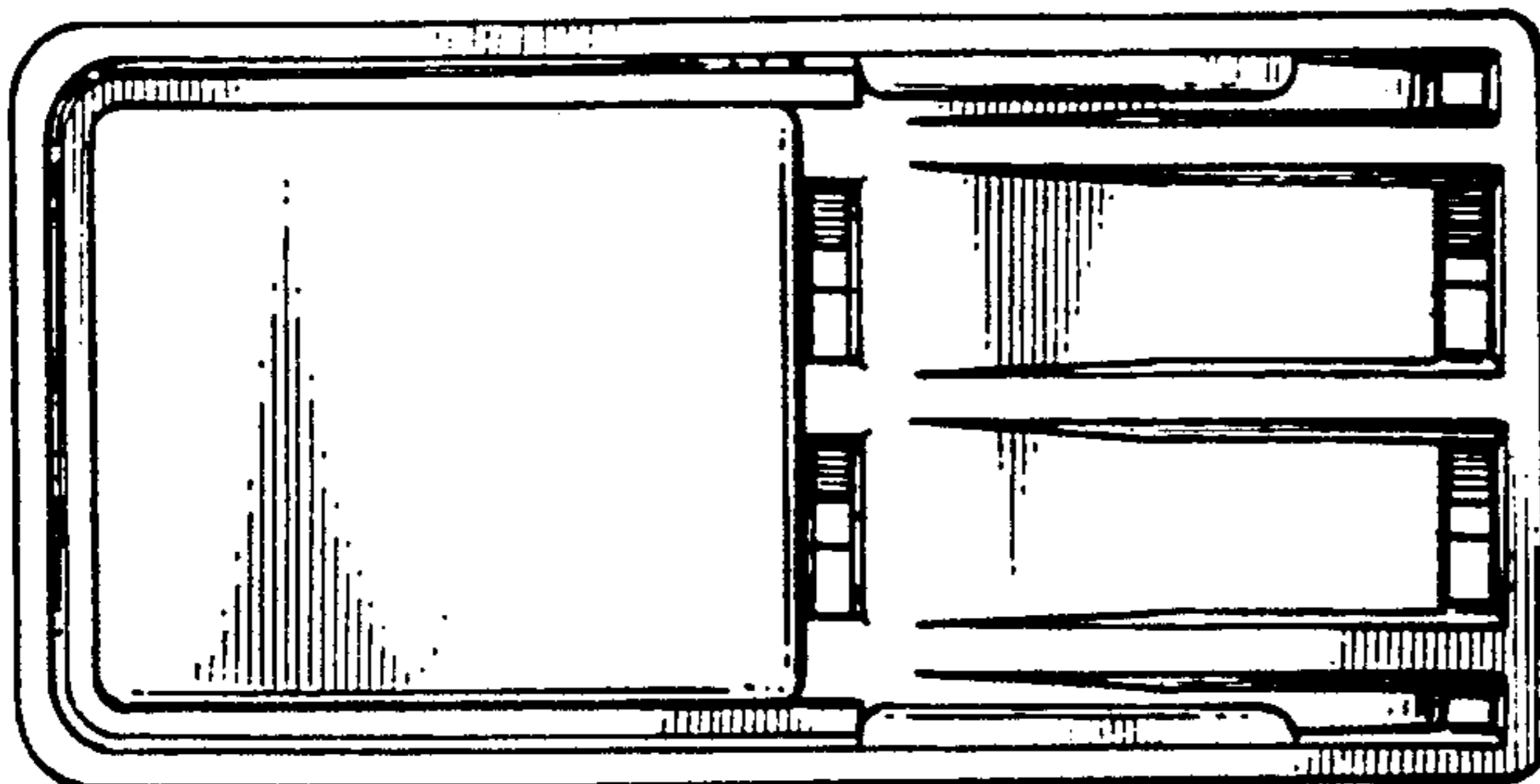

Fig. 6.



UNITED STATES PATENT AND TRADEMARK OFFICE
CERTIFICATE OF CORRECTION

PATENT NO. : Des. 334,973
DATED : Apr. 20, 1993
INVENTOR(S) : A. H. Lynn Valentine, Rudy Gaba

It is certified that error appears in the above-identified patent and that said Letters Patent is hereby corrected as shown below:

Title page, item [73] Assignee, the address should read
"Chatsworth" and not — Torrance—.

Signed and Sealed this
Fifth Day of April, 1994



BRUCE LEHMAN

Commissioner of Patents and Trademarks

Attest:

Attesting Officer