



US00D334962S

United States Patent [19]

[11] Patent Number: **Des. 334,962**

DiLuciano

[45] Date of Patent: **** Apr. 20, 1993**

- [54] **AMUSEMENT GRIP STRENGTH TESTER MACHINE**
- [75] Inventor: **Mark A. DiLuciano, Wakeman, Ohio**
- [73] Assignee: **Sunmark Business Products, Inc., Lorain, Ohio**
- [**] Term: **14 Years**
- [21] Appl. No.: **770,964**
- [22] Filed: **Oct. 4, 1991**
- [52] U.S. Cl. **D21/240**
- [58] Field of Search **D21/240, 198, 191, 222; 273/438, 440; 482/23, 44, 51, 92; 73/865.6, 866.3; D13/168, 173, 172; D6/486, 495**

3,664,181 5/1972 Conrad et al. 73/865.6 X

Primary Examiner—Bernard Ansher
Assistant Examiner—Prabhakar Deshmukh
Attorney, Agent, or Firm—Pearne, Gordon, McCoy & Granger

[57] CLAIM

The ornamental design for an amusement grip strength tester machine, as shown and described.

DESCRIPTION

FIG. 1 is a perspective view of an amusement grip strength tester machine showing my new design; FIG. 2 is a top plan view thereof; FIG. 3 is a perspective view thereof shown without the bottom support for clarity of illustration; FIG. 4 is a front elevational view of FIG. 3; FIG. 5 is a top plan view of FIG. 3; FIG. 6 is a right side elevational view of FIG. 3; the left side elevational view being a mirror image thereof; FIG. 7 is a bottom plan view of FIG. 3; and, FIG. 8 is a rear elevational view of FIG. 3. FIGS. 2 through 8 are shown in an enlarged scale for clarity of illustration.

[56] References Cited

U.S. PATENT DOCUMENTS

- D. 36,608 10/1903 Reade et al. D6/486 X
- D. 83,560 3/1931 Meyer D21/240
- D. 135,411 4/1943 Meyer D21/240
- D. 149,509 5/1948 Meyer D21/240
- D. 288,108 2/1987 Hata D21/198
- D. 295,004 4/1988 Schultz et al. D6/495

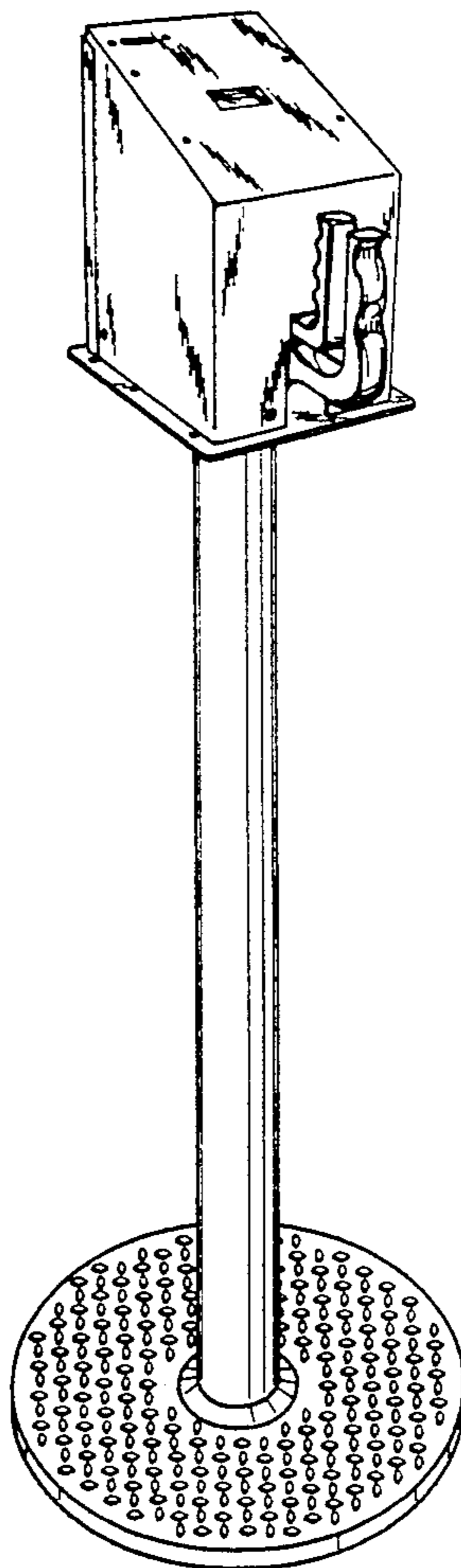

Fig. 1

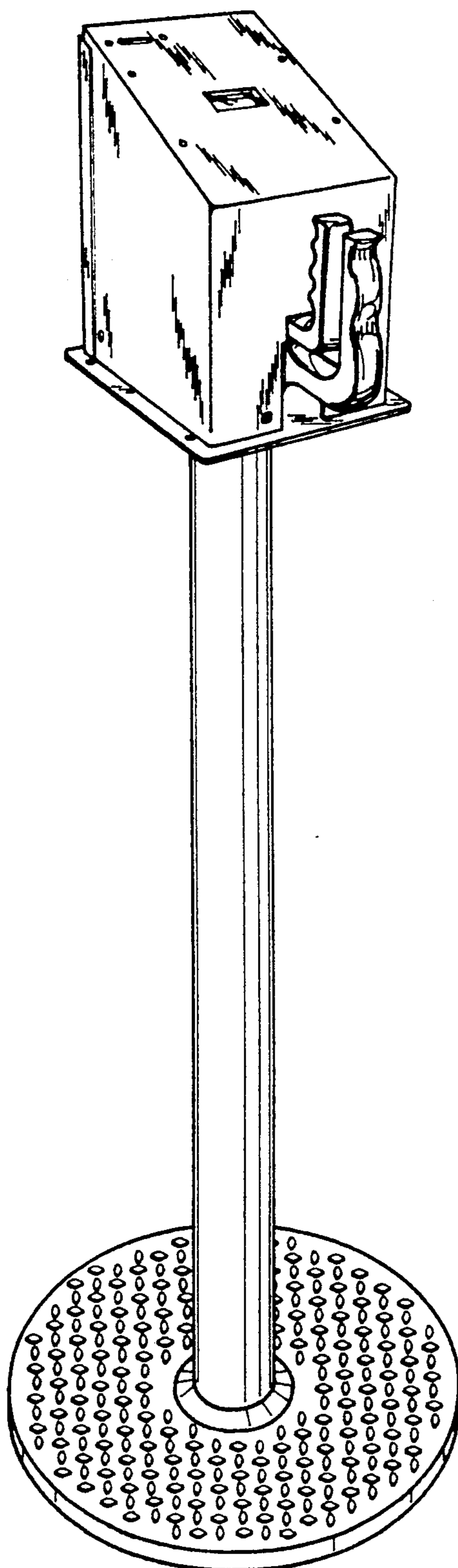

Fig. 2

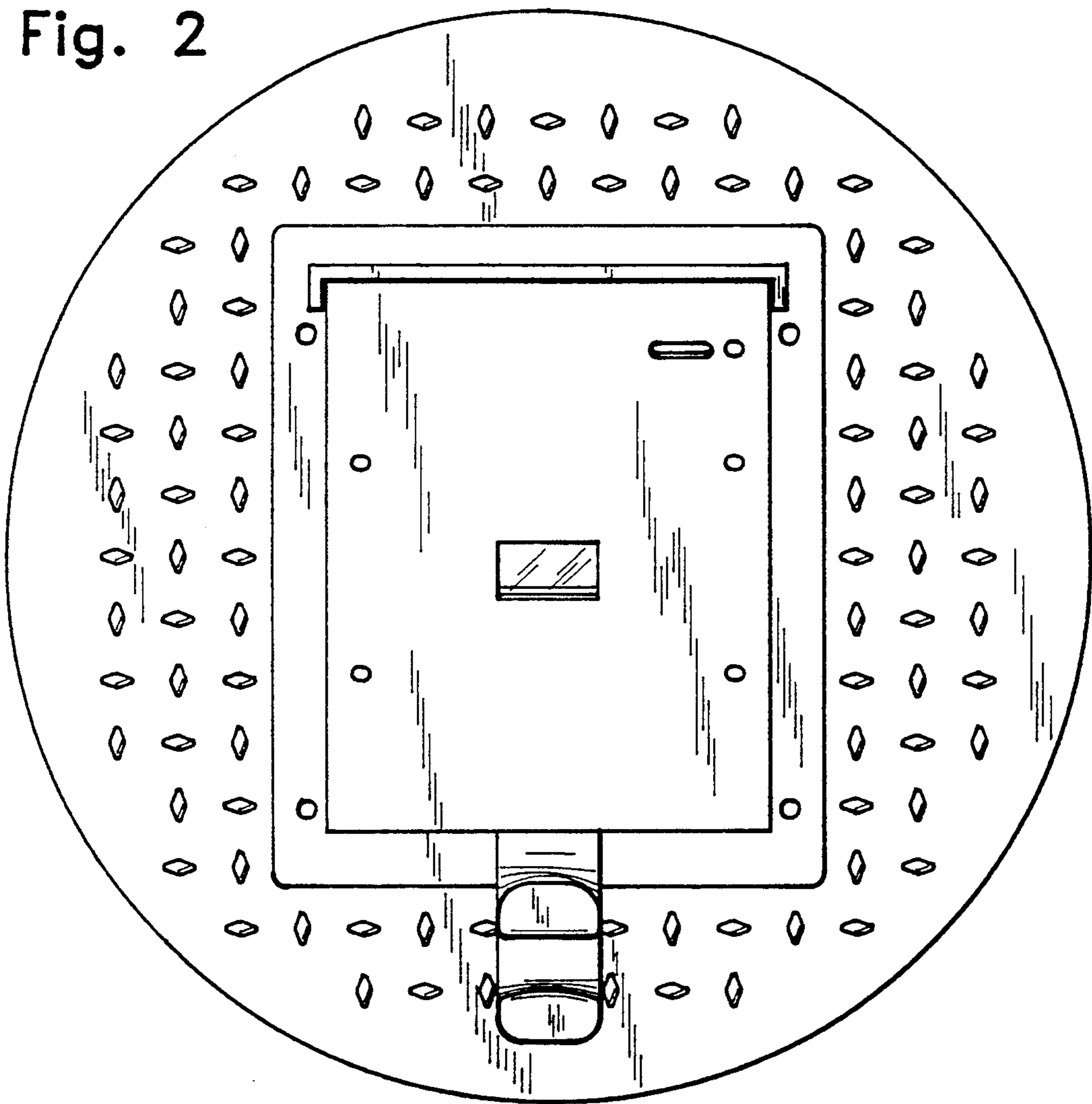

Fig. 3

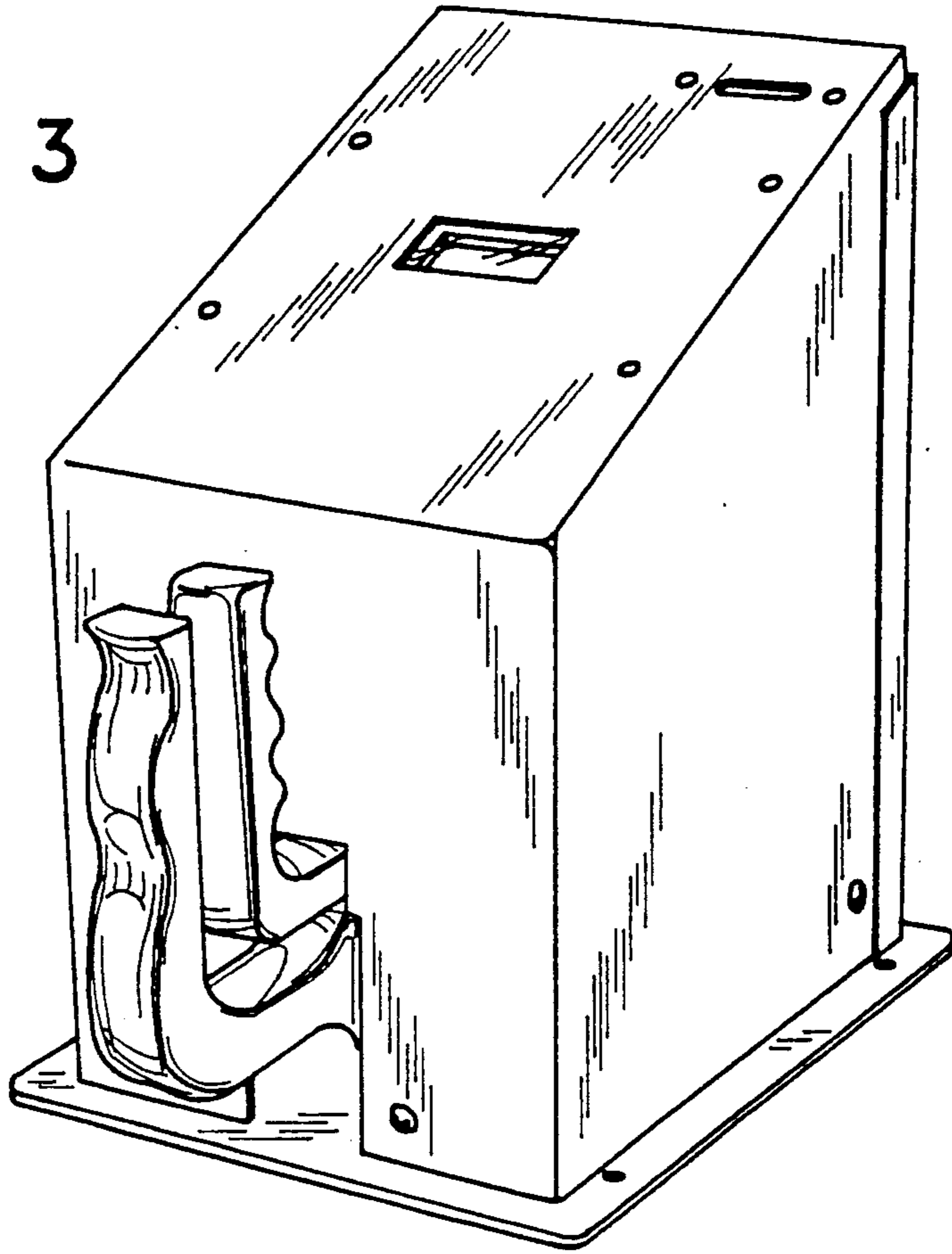

Fig. 4

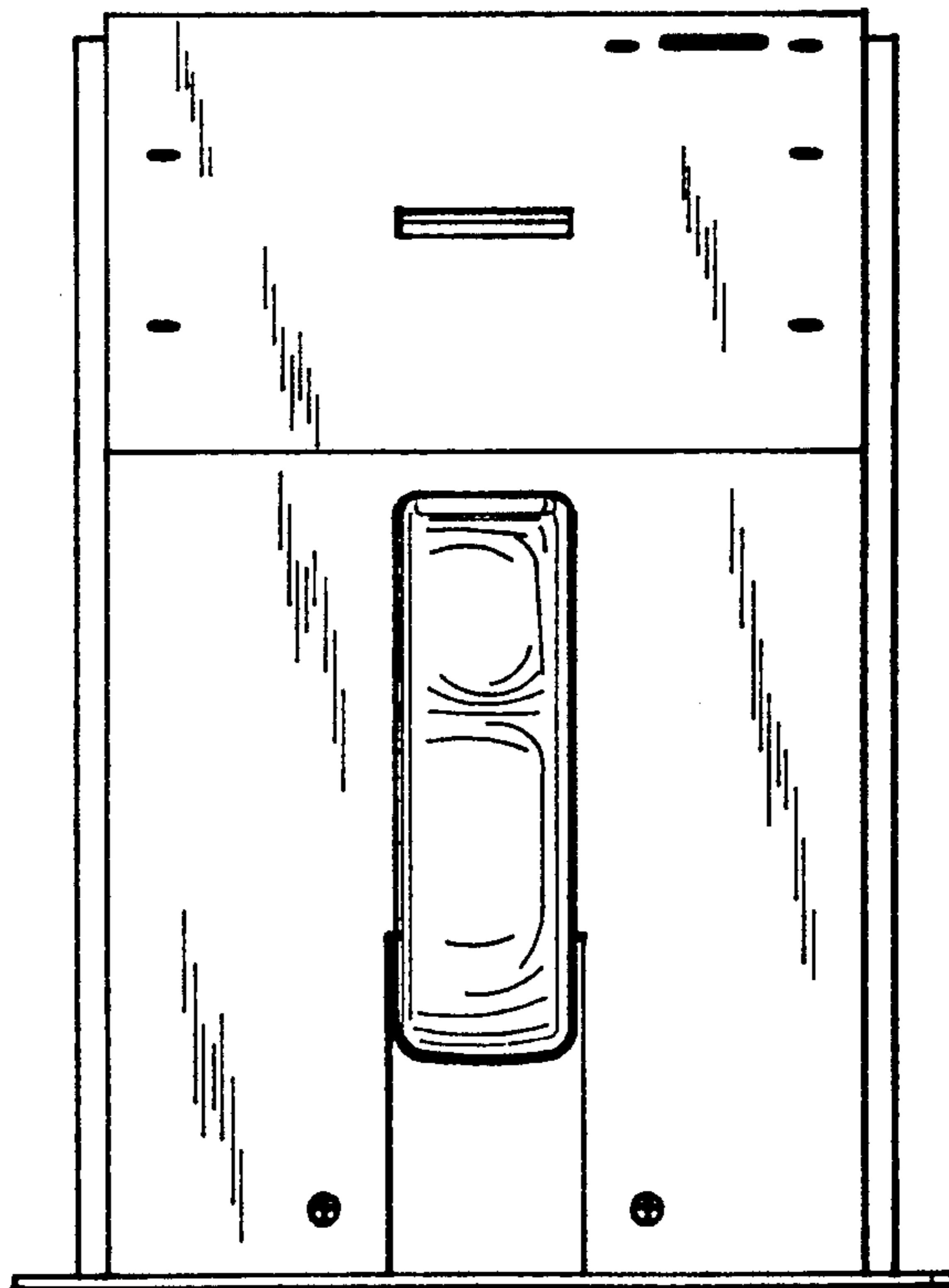

Fig. 5

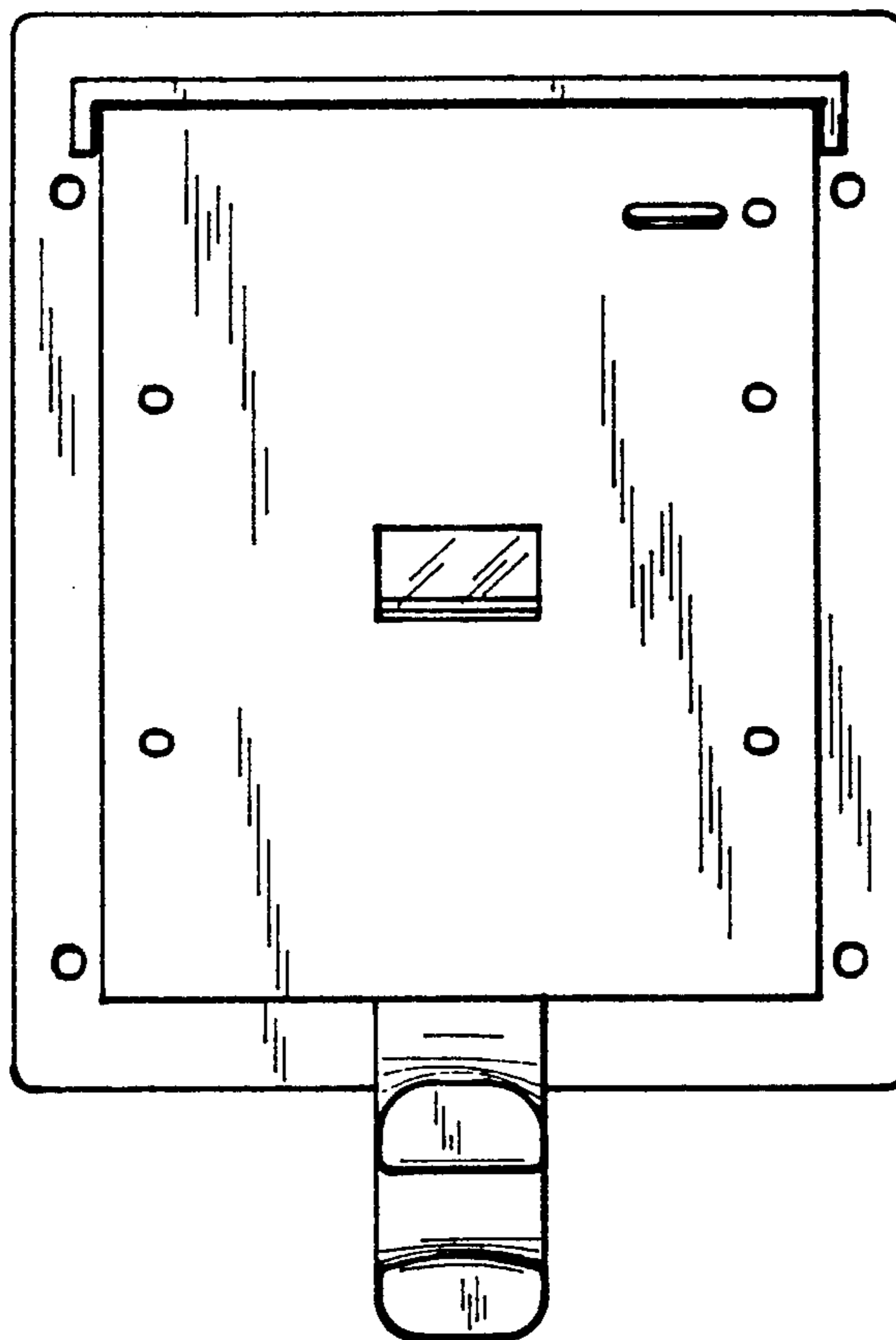

Fig. 6

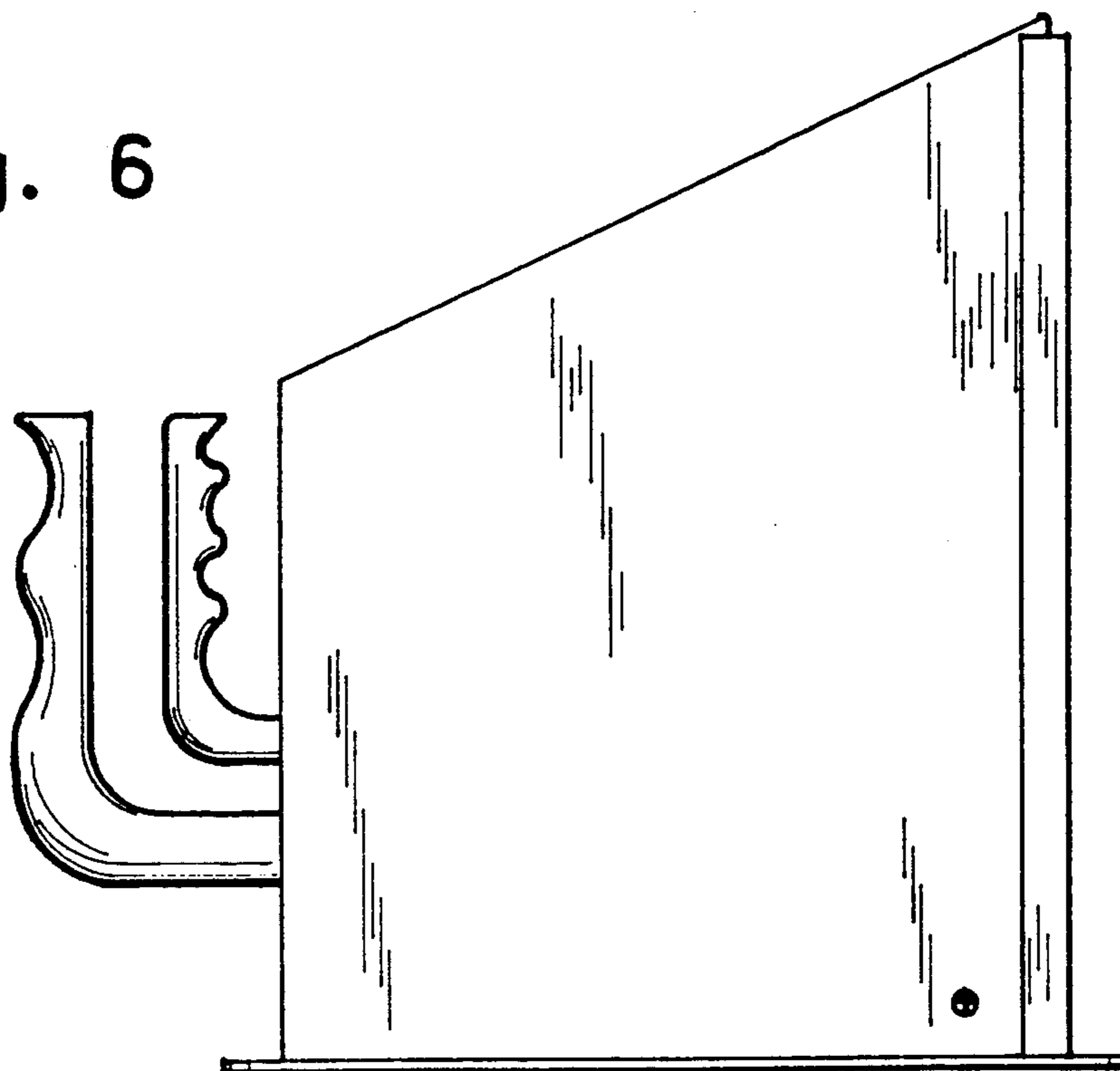

Fig. 7

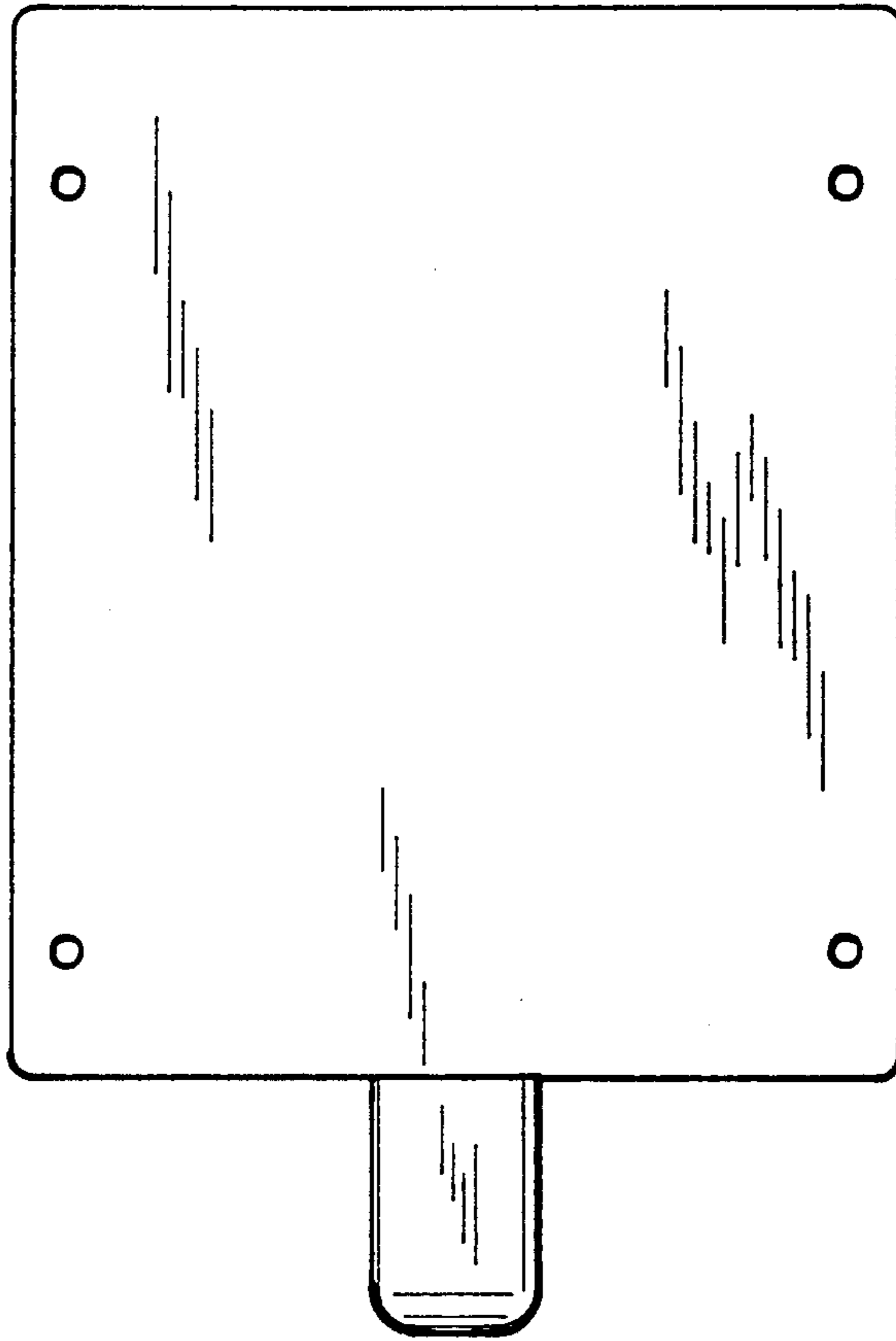

Fig. 8

