



US00D334930S

United States Patent [19]

Collins

[11] Patent Number: Des. 334,930

[45] Date of Patent: ** Apr. 20, 1993

[54] COMBINATION ALARM CLOCK AND TAPE RECORDER

[76] Inventor: Frank D. Collins, 5539 Hoyne, Chicago, Ill. 60636

[**] Term: 14 Years

[21] Appl. No.: 578,847

[22] Filed: Sep. 6, 1990

[52] U.S. Cl. D14/168; D14/171

[58] Field of Search D14/154, 160-172, D14/188-198, 257, 259, 265, 299; 455/344, 347, 350, 351; 312/7.1; D10/2, 15

[56] **References Cited**

U.S. PATENT DOCUMENTS

- D. 241,977 10/1976 Makino et al. D14/171
- D. 245,909 9/1977 Kawano D14/171
- D. 261,765 11/1981 Mishiro D10/2 X
- D. 296,786 7/1988 Baskin D14/171

- 3,420,051 1/1969 Matteson .
- 3,835,640 9/1974 Hughes .
- 4,498,787 2/1985 Jung-Sun .

Primary Examiner—Theodore M. Shooman
Attorney, Agent, or Firm—Terry M. Gernstein

[57] **CLAIM**

The ornamental design for a combination alarm clock and tape recorder, as shown and described.

DESCRIPTION

FIG. 1 is a perspective view of the combination alarm clock and tape recorder embodying the design of the present invention;

FIG. 2 is a front elevational view thereof;

FIG. 3 is a rear elevational view thereof;

FIG. 4 is a side elevational view thereof, the side opposite being a mirror image of the side shown in FIG. 4;

FIG. 5 is a top plan view thereof; and,

FIG. 6 is a bottom view thereof.

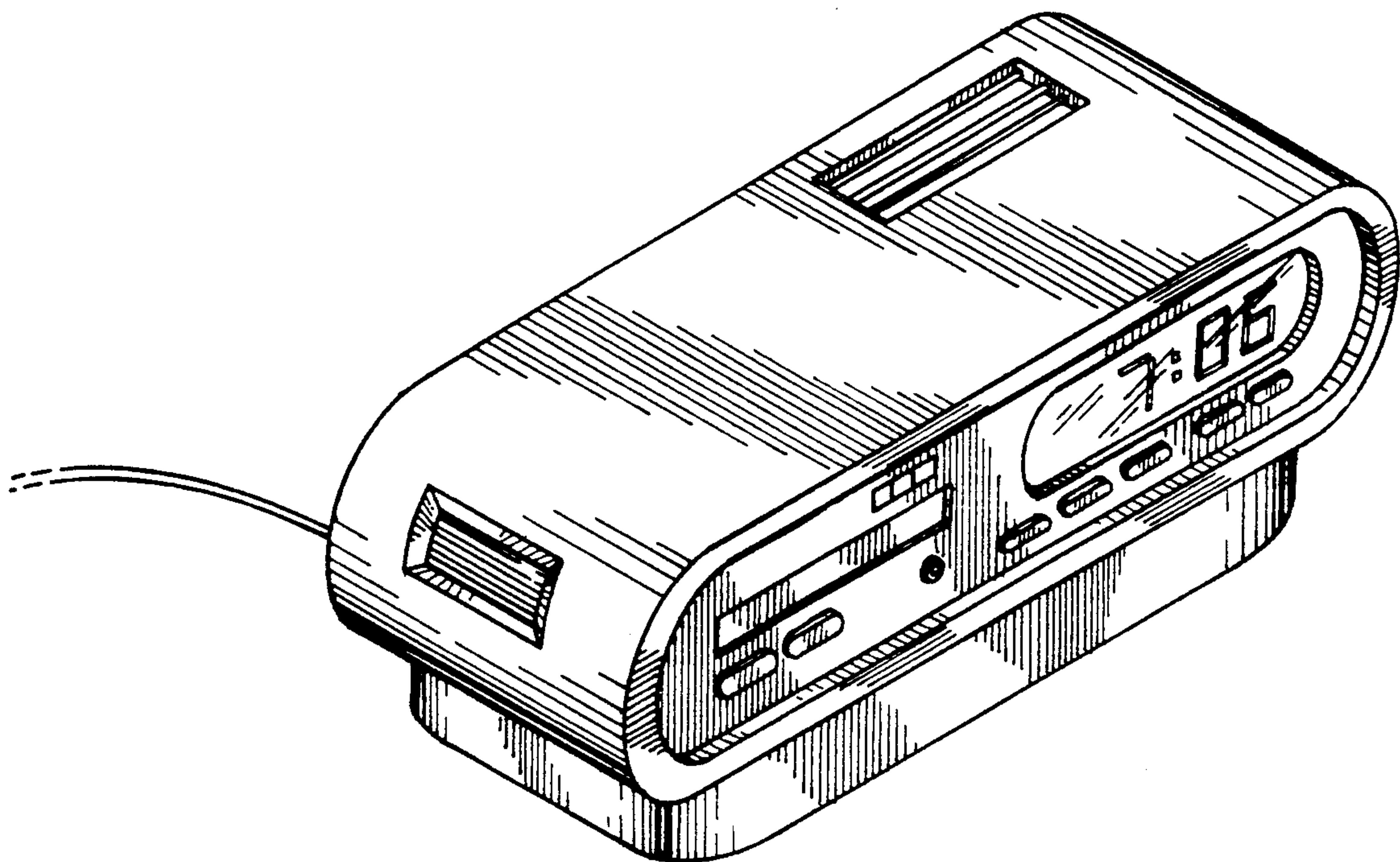

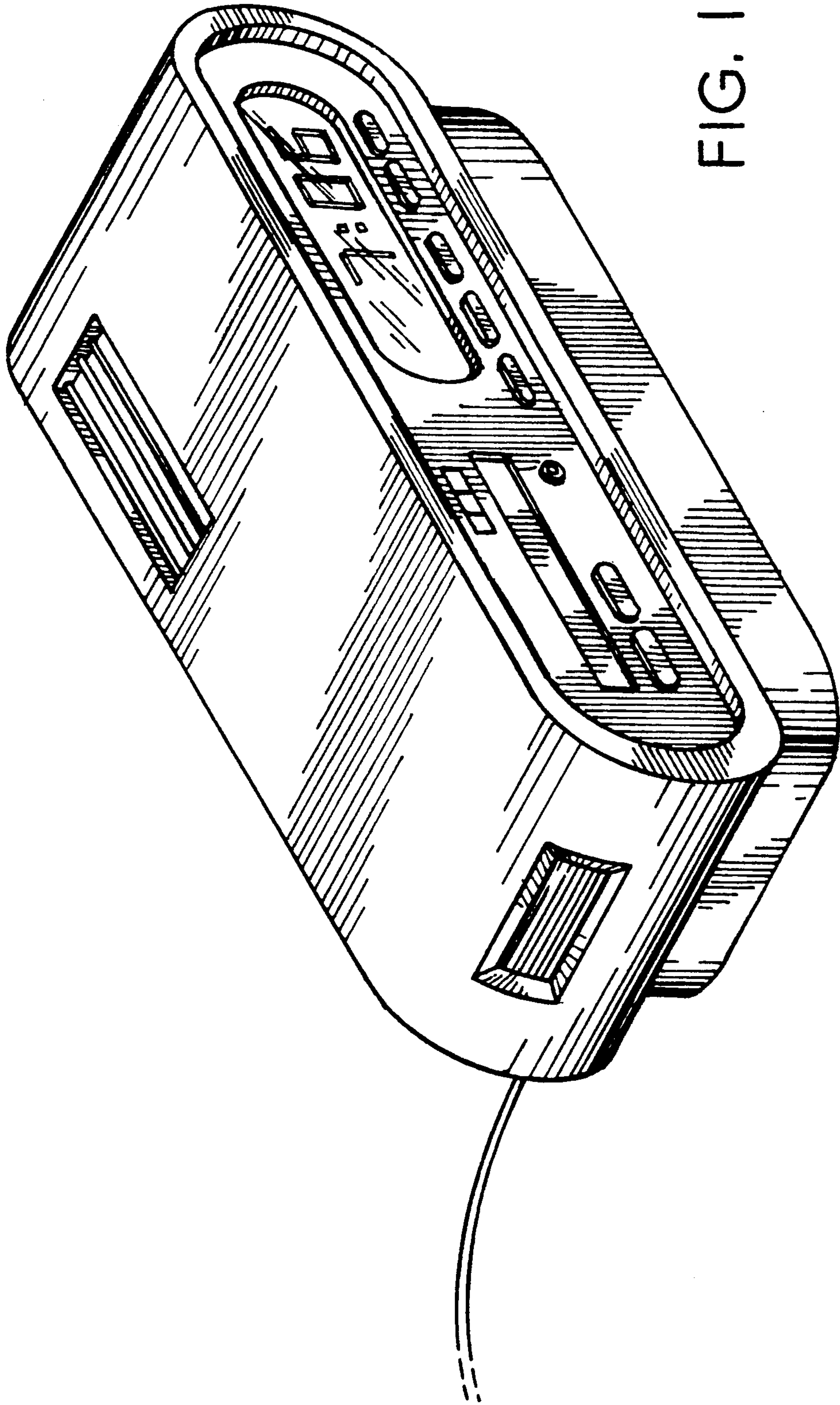

FIG. 1

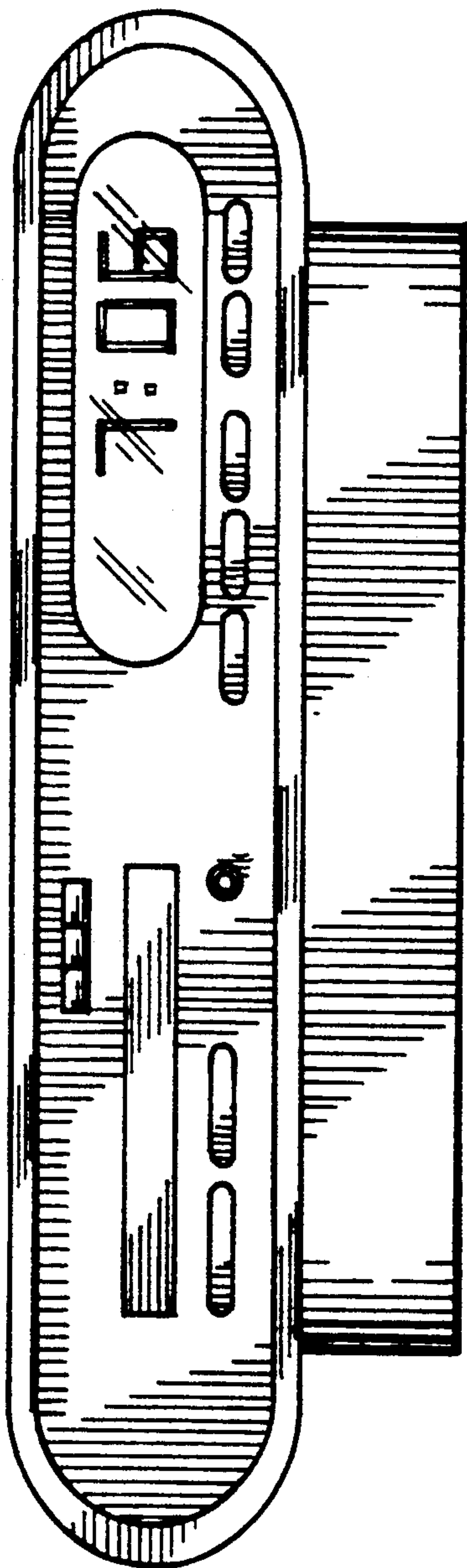

FIG. 2

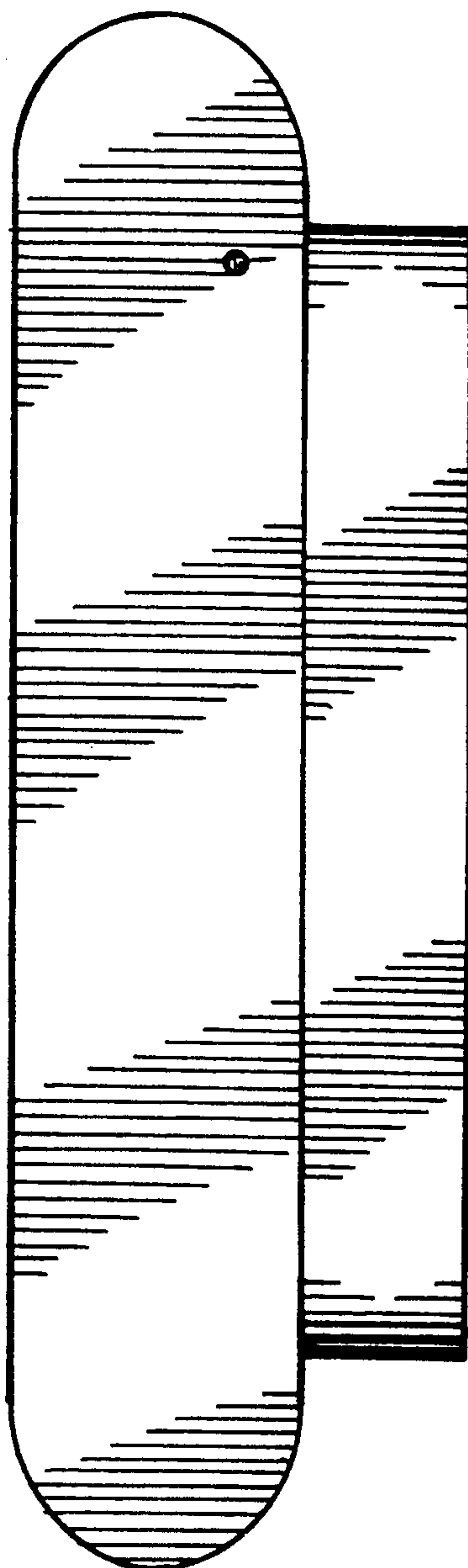

FIG. 3

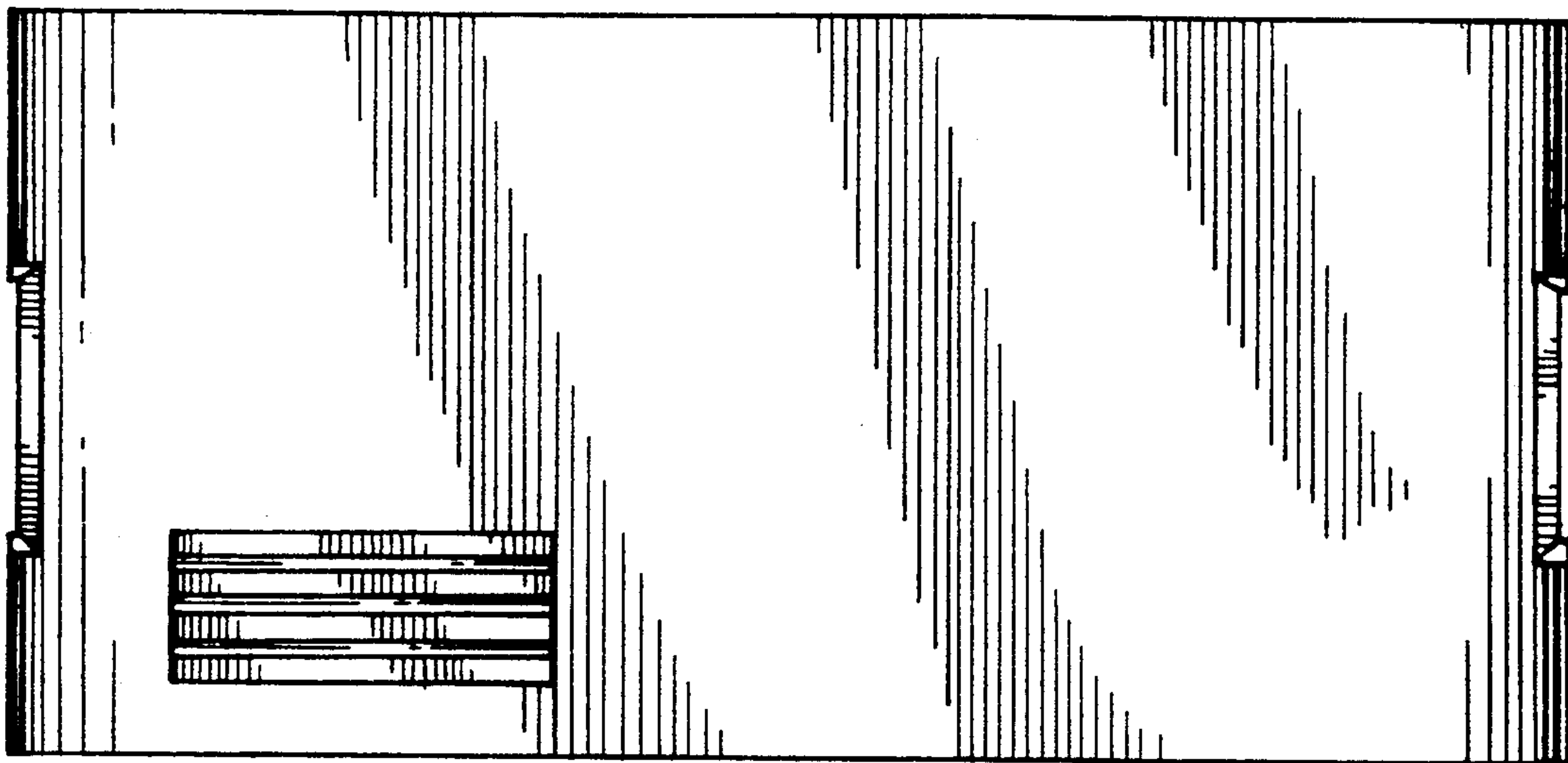
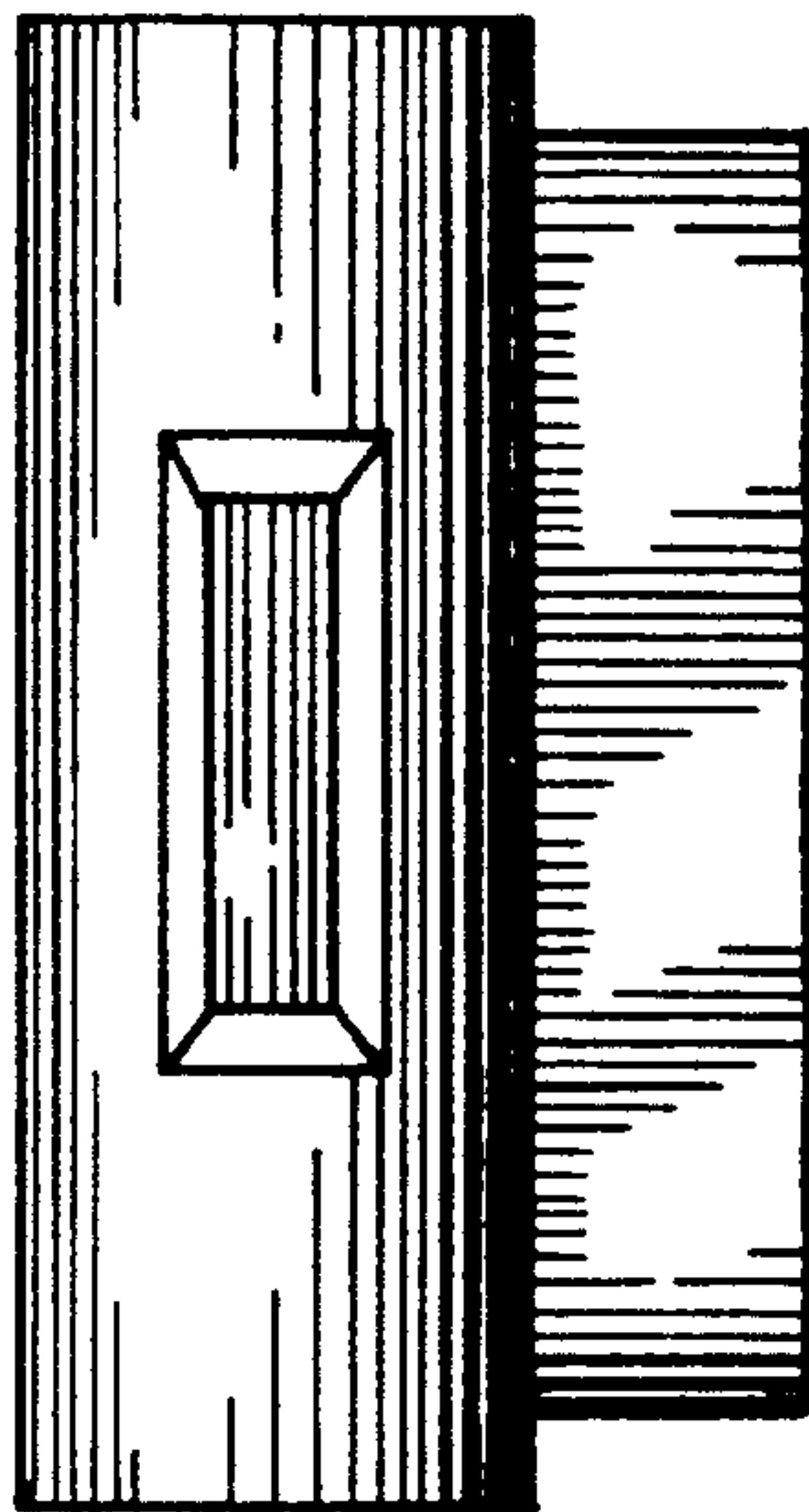

FIG. 5

FIG. 4



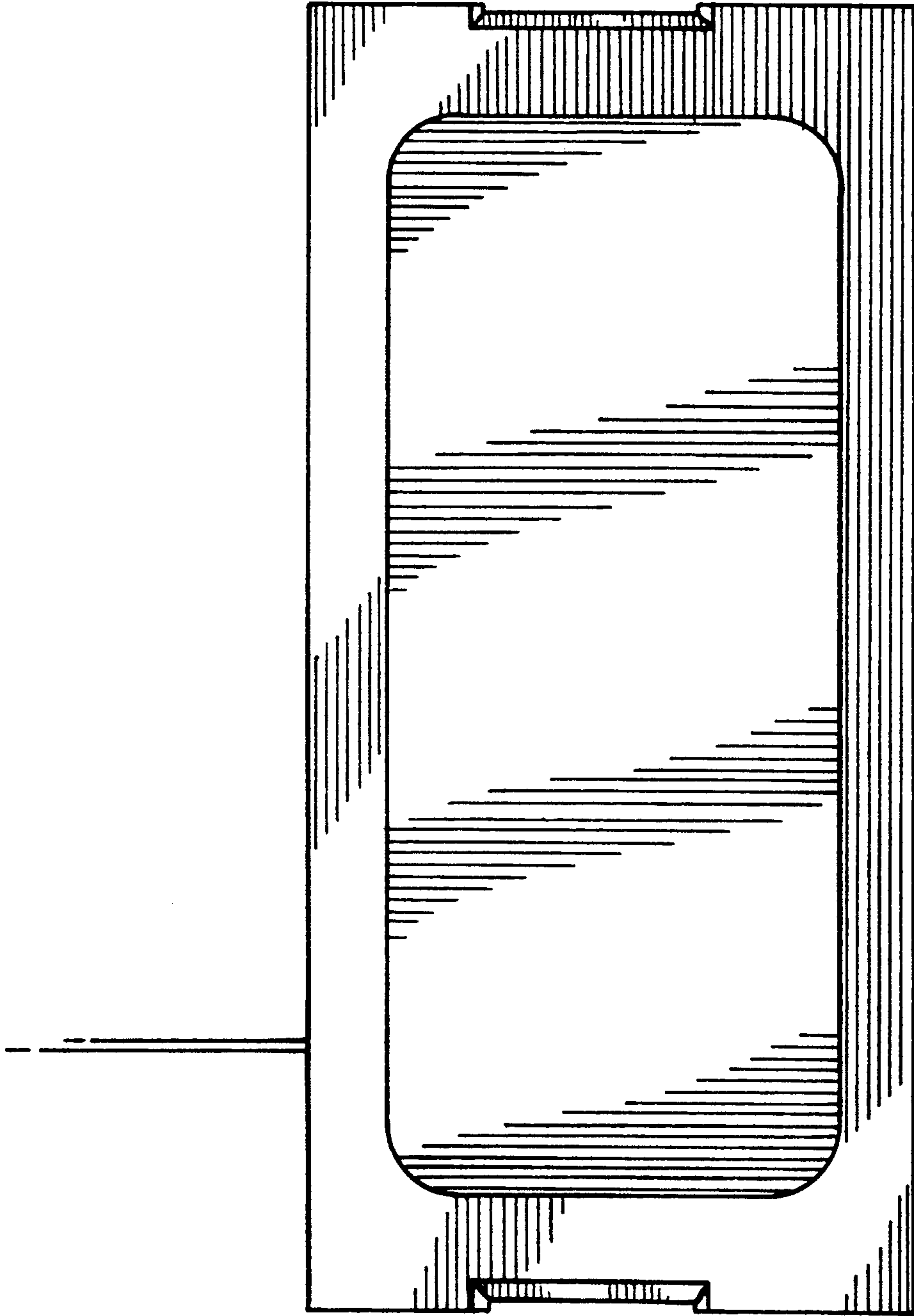

FIG. 6