



US00D334895S

# United States Patent [19]

[11] Patent Number: **Des. 334,895**

Bavand

[45] Date of Patent: **\*\* Apr. 20, 1993**

[54] COIN SCALE

3,592,277 7/1971 Akeret ..... 177/126  
4,792,002 12/1988 Ward ..... 177/172 X

[76] Inventor: **Farzad F. Bavand**, 1384 Oakland Bl  
Apt. 9, Walnut Creek, Calif.  
94596-4352

*Primary Examiner*—Alan P. Douglas  
*Assistant Examiner*—Antoine O. Davis  
*Attorney, Agent, or Firm*—Leon Gilden

[\*\*] Term: **14 Years**

[57] **CLAIM**

[21] Appl. No.: **570,690**

The ornamental design for a coin scale, as shown and described.

[22] Filed: **Aug. 22, 1990**

[52] U.S. Cl. .... **D10/87**

### DESCRIPTION

[58] Field of Search ..... D10/83, 87, 88, 89,  
D10/91, 97; 177/172, 200, 211, 238, 239, 240,  
241, 242, 243, 244, 253, 225

FIG. 1 is a front elevational view of the coin scale showing my new design;

FIG. 2 is a rear elevational view thereof;

FIG. 3 is a left side elevational view thereof;

FIG. 4 is a right side elevational view thereof;

FIG. 5 is a top plan view thereof;

FIG. 6 is a bottom plan view thereof; and,

FIG. 7 is a perspective view thereof.

[56] **References Cited**

#### U.S. PATENT DOCUMENTS

D. 269,600 7/1983 Mox ..... D10/91  
1,850,179 3/1932 Merchen ..... 177/211

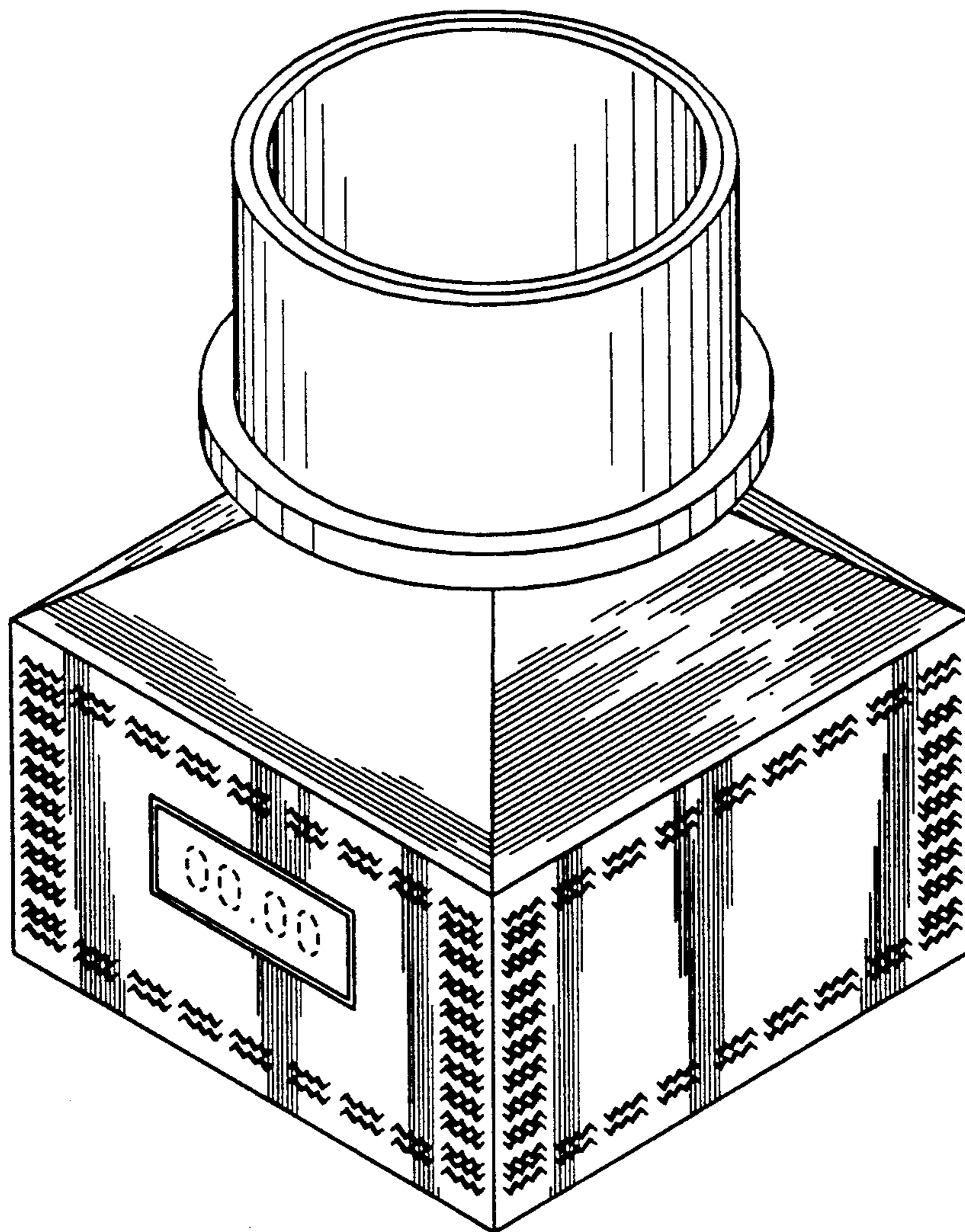

FIG. 1

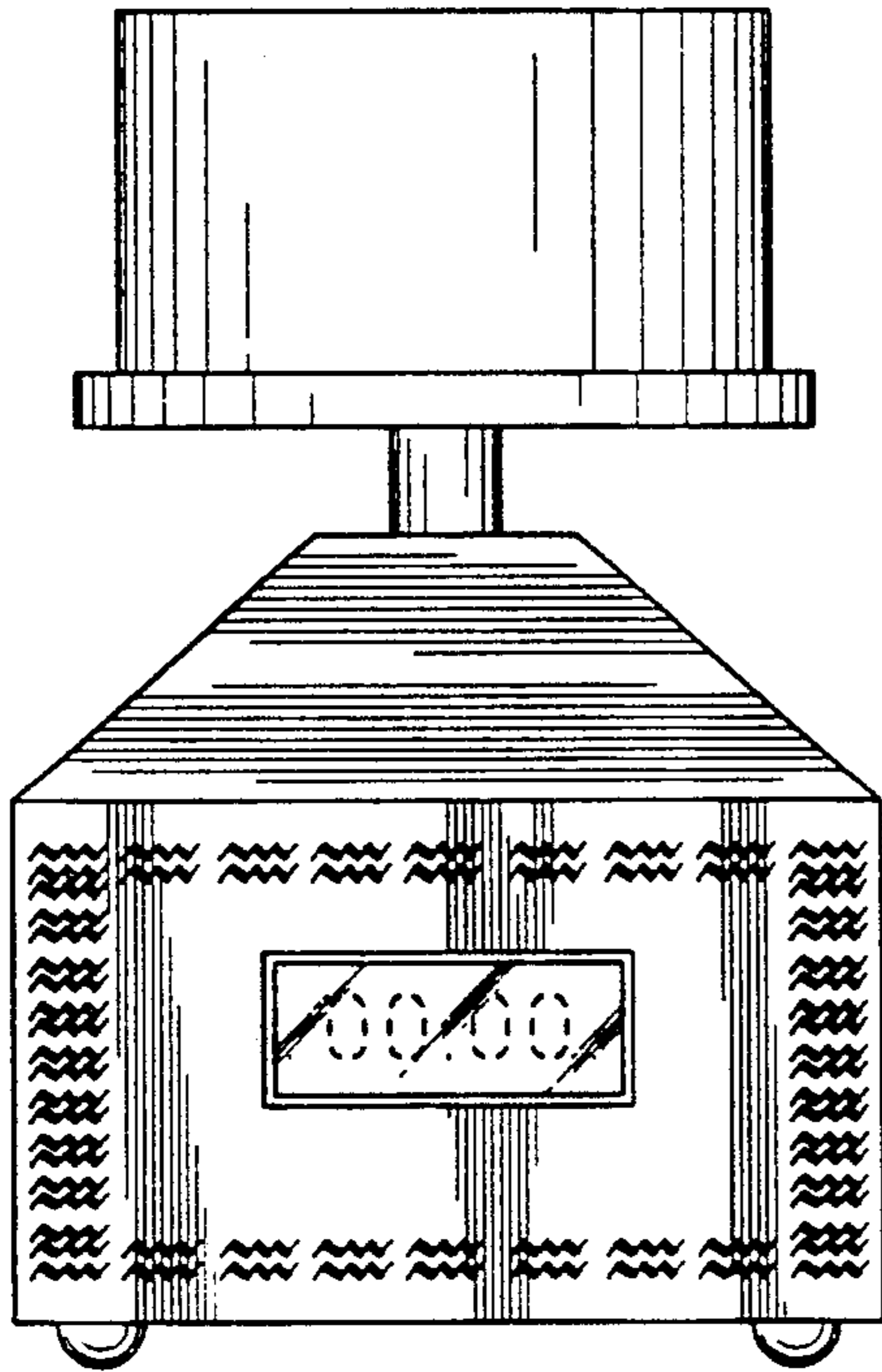

FIG. 2

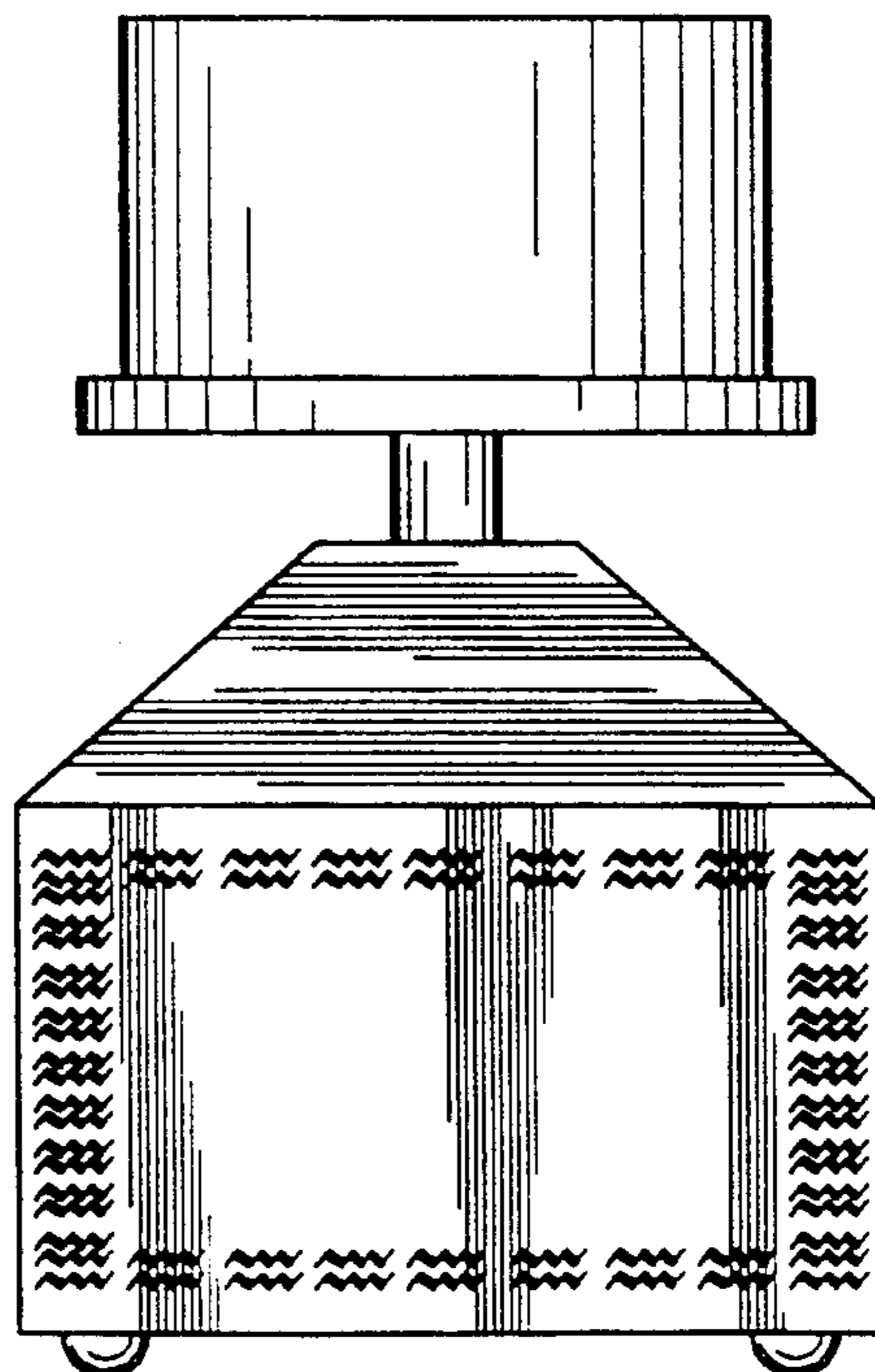

FIG. 3

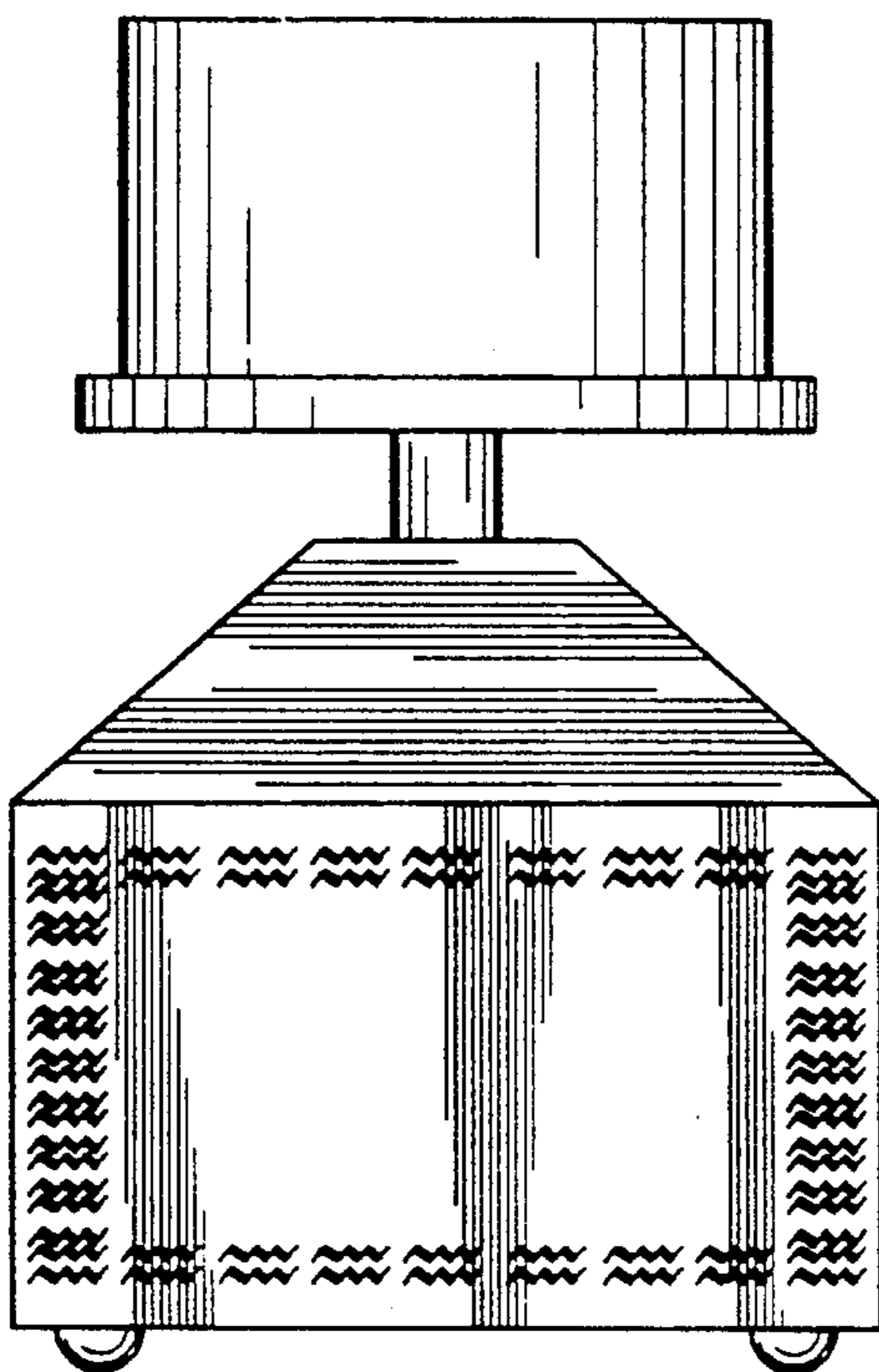
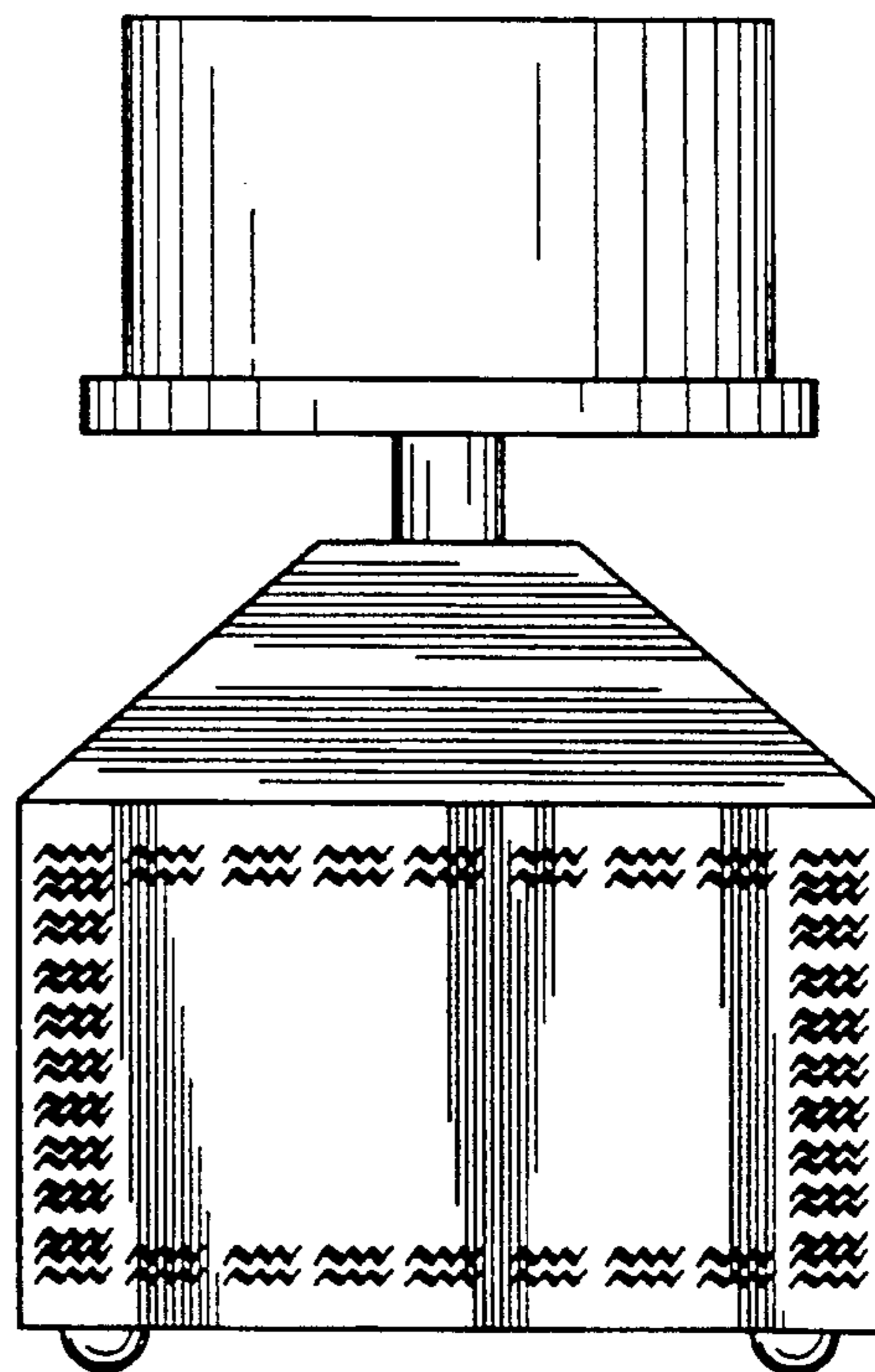
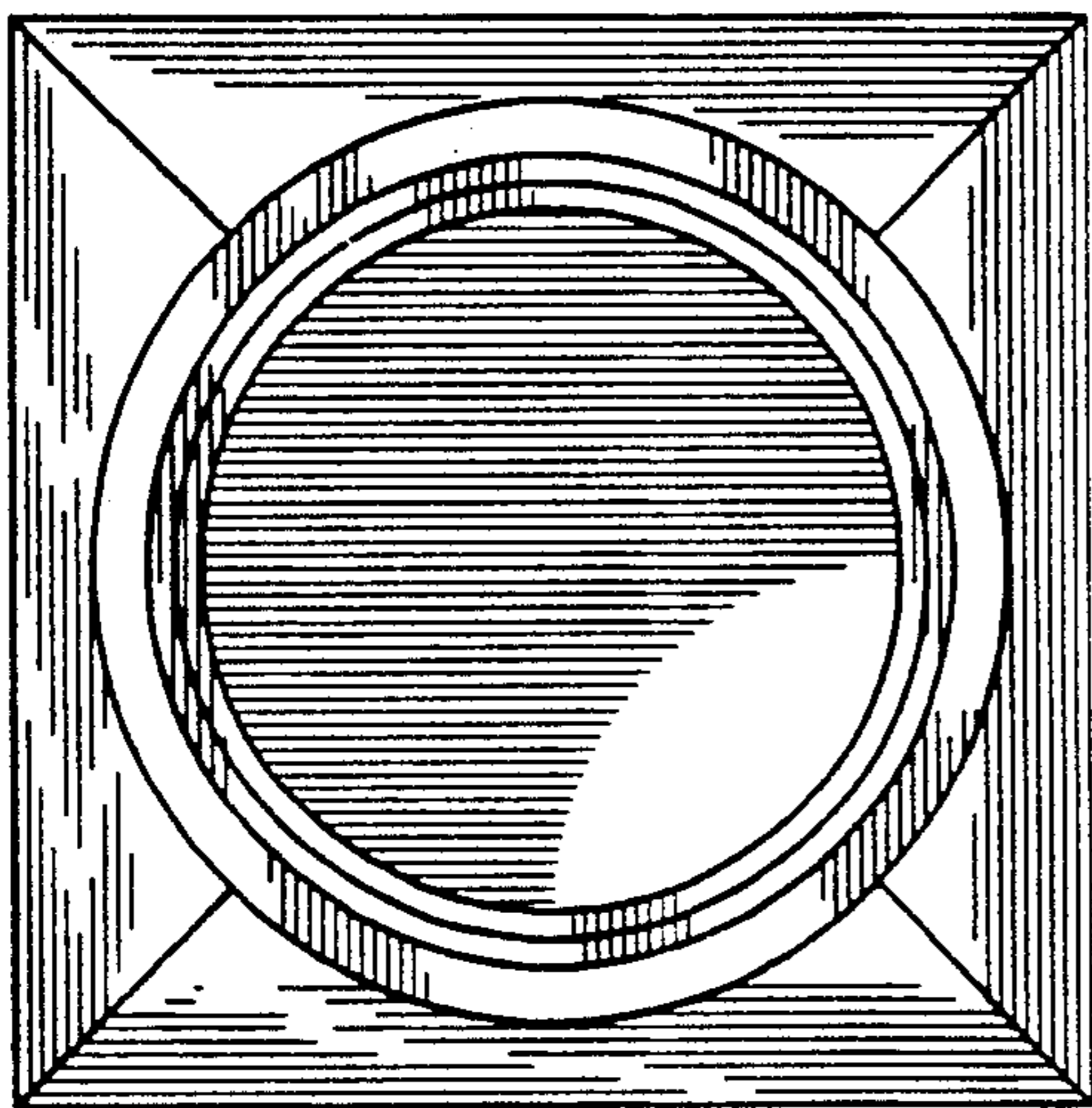

FIG. 4



*FIG. 5*



*FIG. 6*

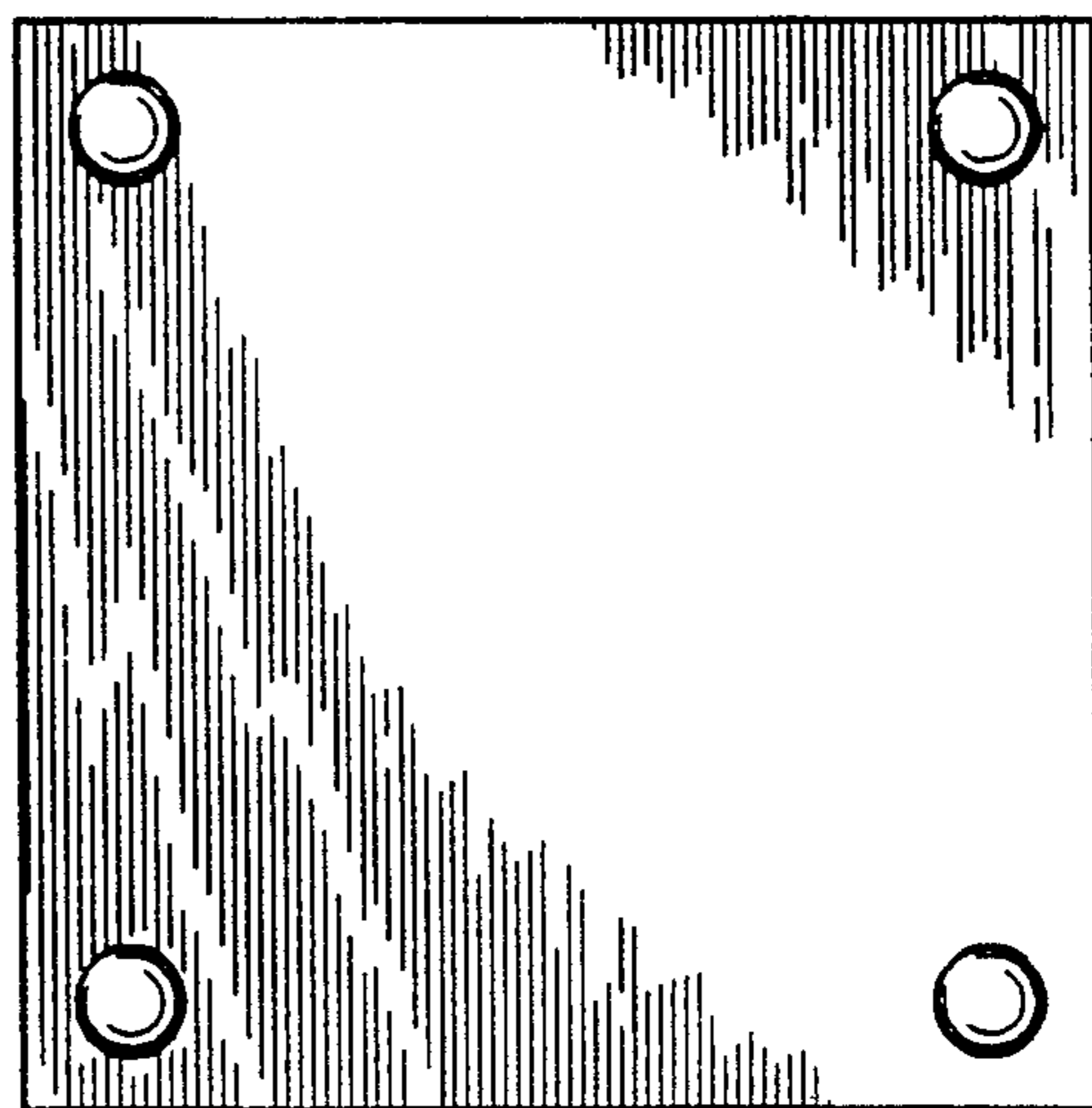

FIG. 7

