



US00D334892S

United States Patent [19]

[11] Patent Number: **Des. 334,892**

Jenkins

[45] Date of Patent: **** Apr. 20, 1993**

[54] **SIDING SPACER TOOL**

[76] Inventor: **Michael R. Jenkins**, 1804 Caney Hills Rd., Knoxville, Tenn. 37921

[**] Term: **14 Years**

[21] Appl. No.: **796,233**

[22] Filed: **Nov. 22, 1991**

995,574 6/1911 Sarlls 33/646
 4,425,714 1/1984 Kelly, Jr. 33/646
 4,654,975 4/1987 Lopez 33/646 X
 4,937,950 7/1990 Farnworth 33/646

Primary Examiner—Alan P. Douglas
Assistant Examiner—Antoine D. Davis
Attorney, Agent, or Firm—Hugh & Smith

Related U.S. Application Data

[63] Continuation-in-part of Ser. No. 597,557, Oct. 15, 1990, abandoned.

[52] U.S. Cl. **D10/64**

[58] Field of Search D10/64, 65, 70, 72; 33/518, 526, 645, 646, 648, 649

References Cited

U.S. PATENT DOCUMENTS

418,754 1/1890 Schill 33/646

[57] CLAIM

The ornamental design for a siding spacer tool, as shown and described.

DESCRIPTION

FIG. 1 is a front elevational view of the siding spacer tool, showing my new design;
 FIG. 2 is a rear elevational view thereof;
 FIG. 3 is a left side elevational view thereof;
 FIG. 4 is a right side elevational view thereof;
 FIG. 5 is a top plan view thereof;
 FIG. 6 is a bottom plan view thereof; and,
 FIG. 7 is an isometric view thereof.

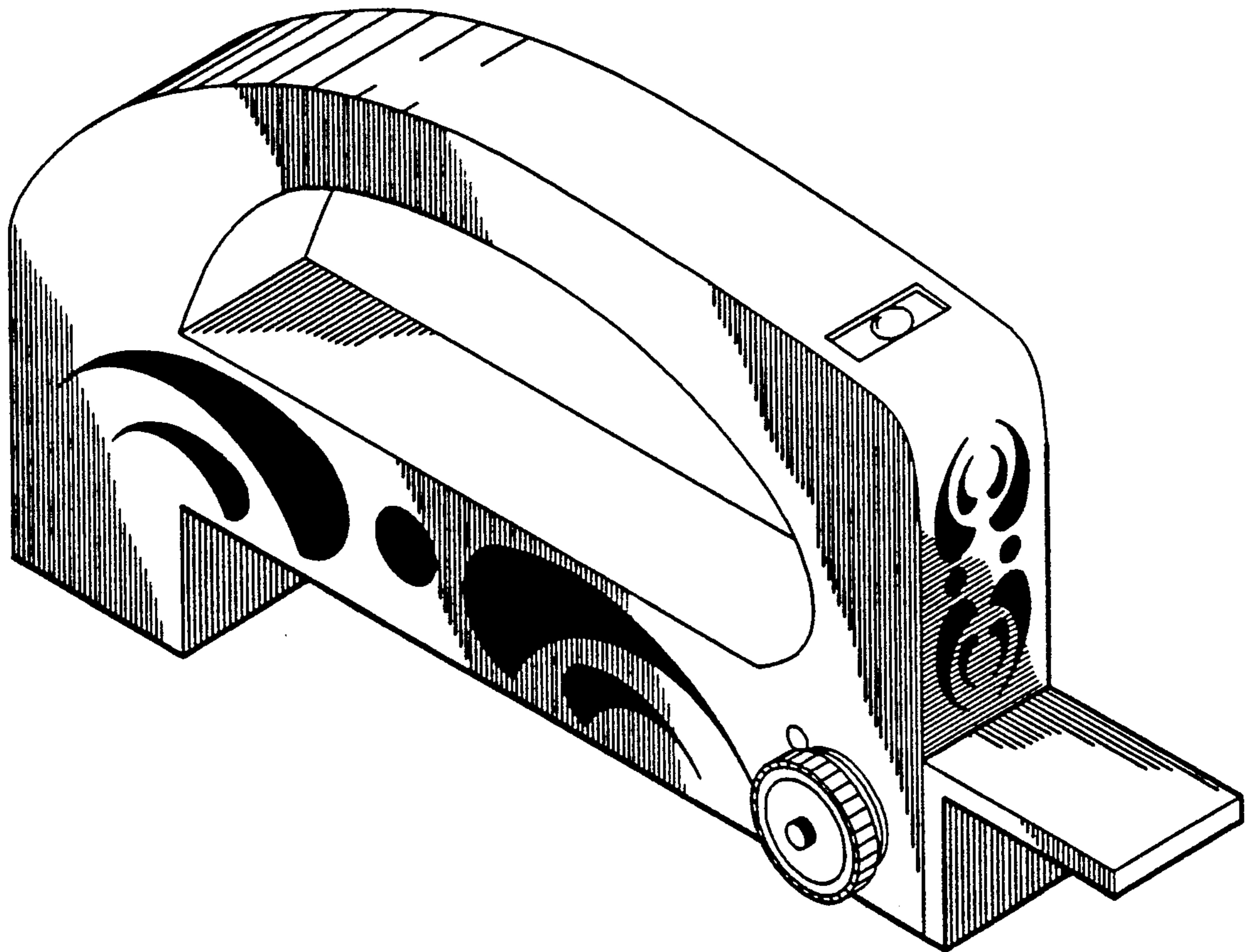

FIG. 1

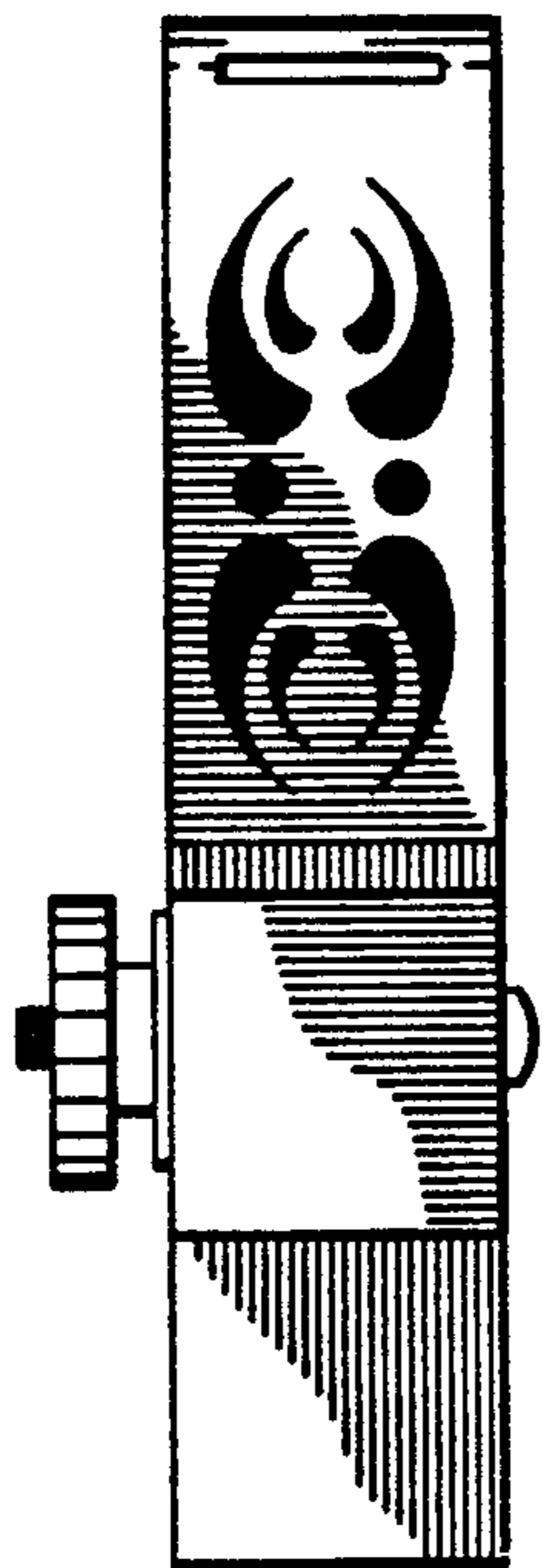

FIG. 2

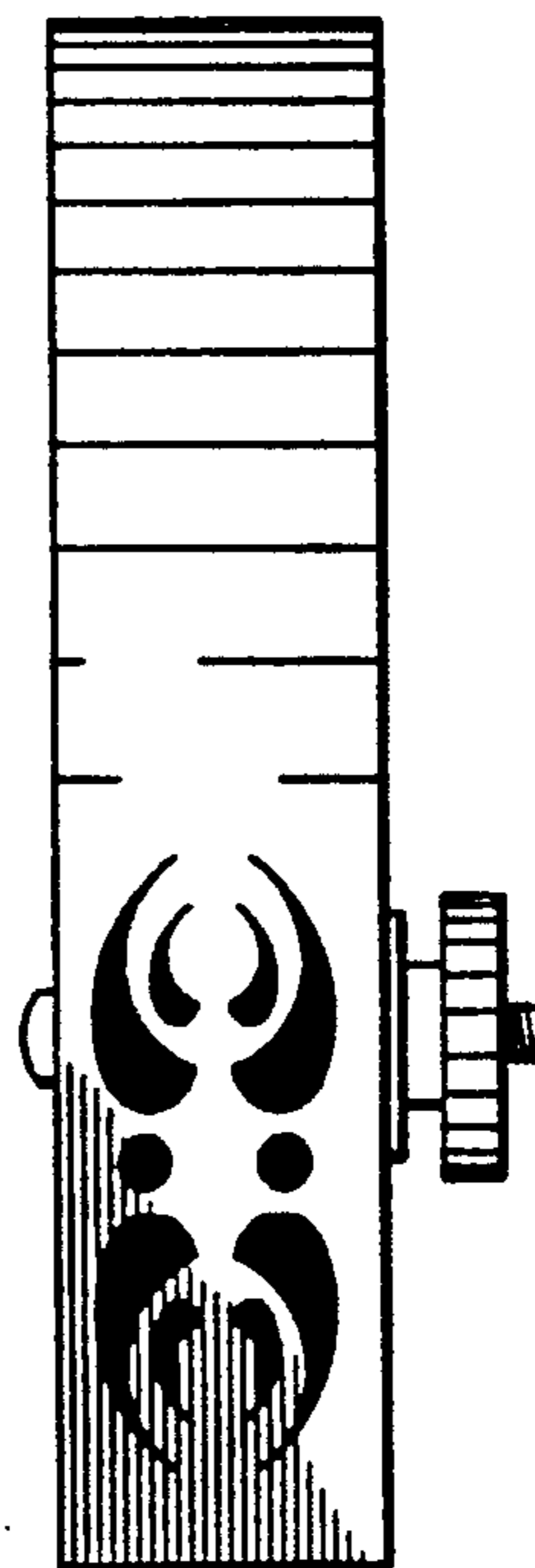

FIG. 3

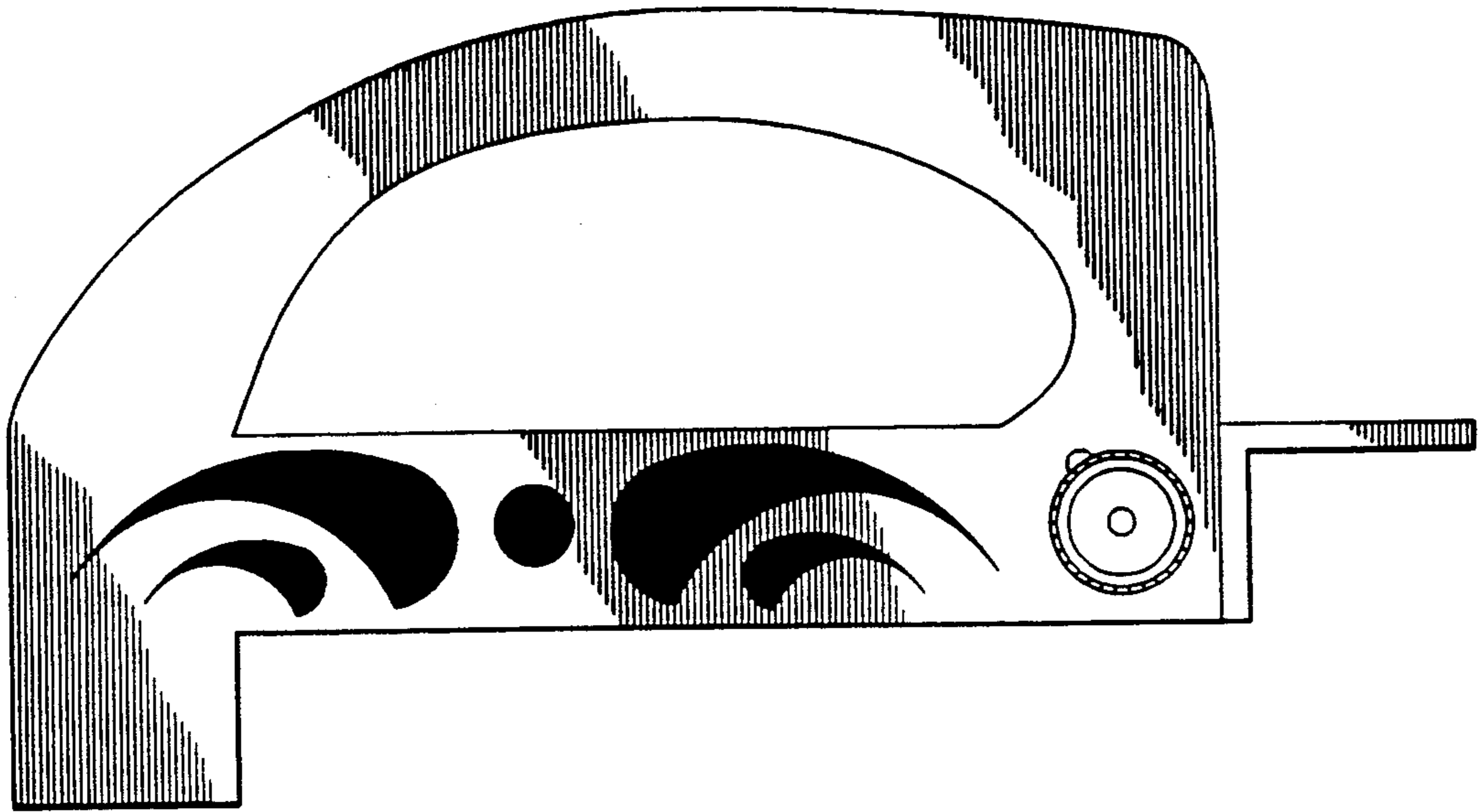

FIG. 4

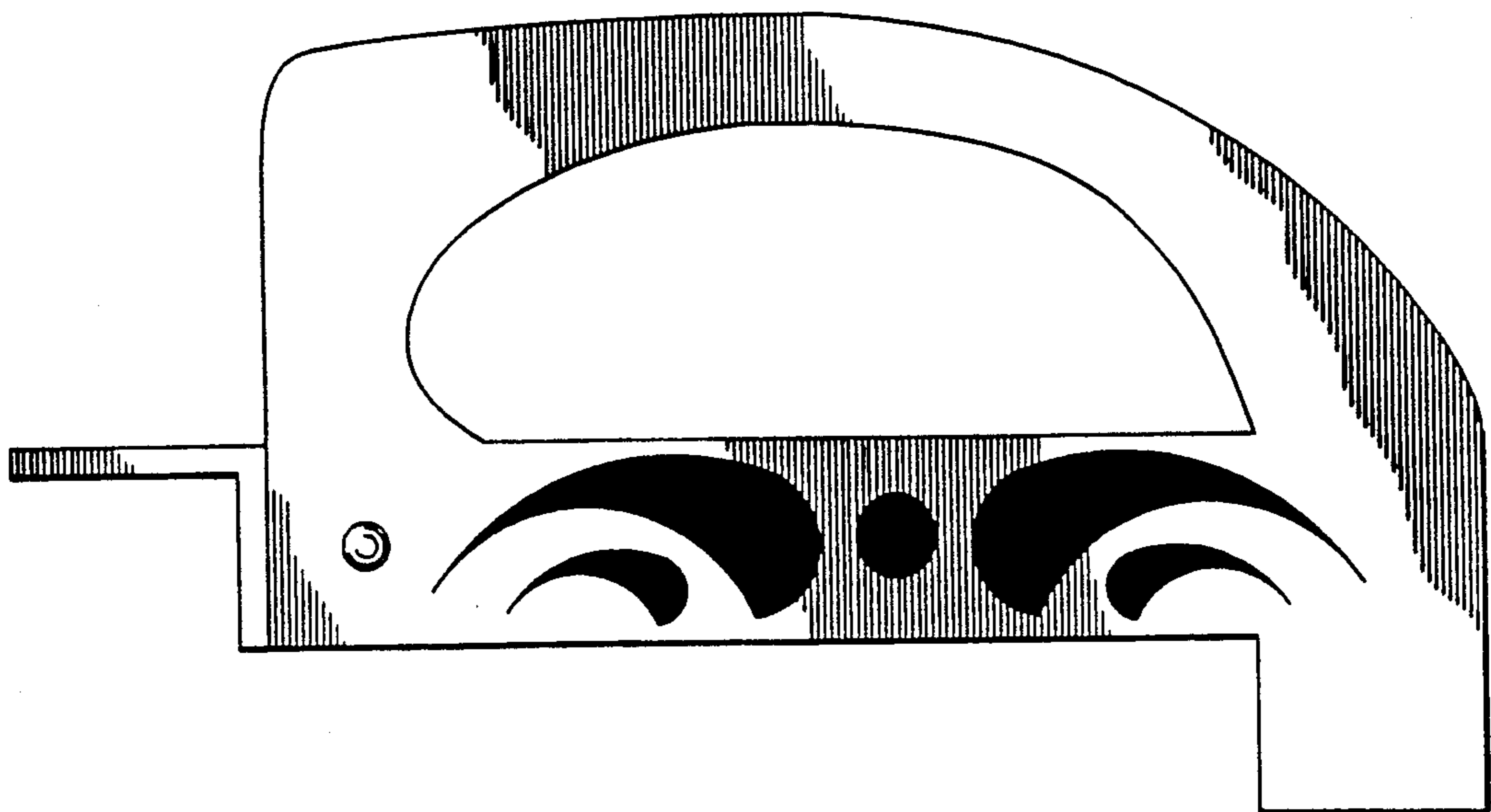

FIG. 5

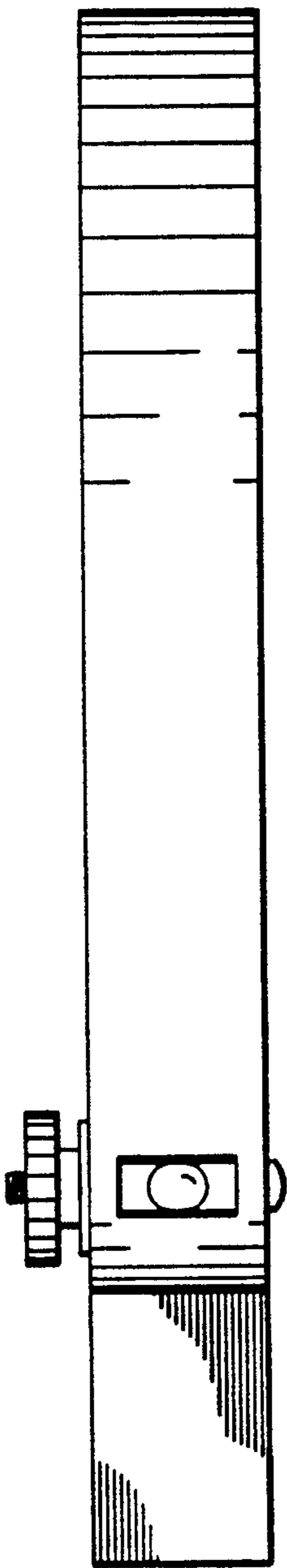

FIG. 6

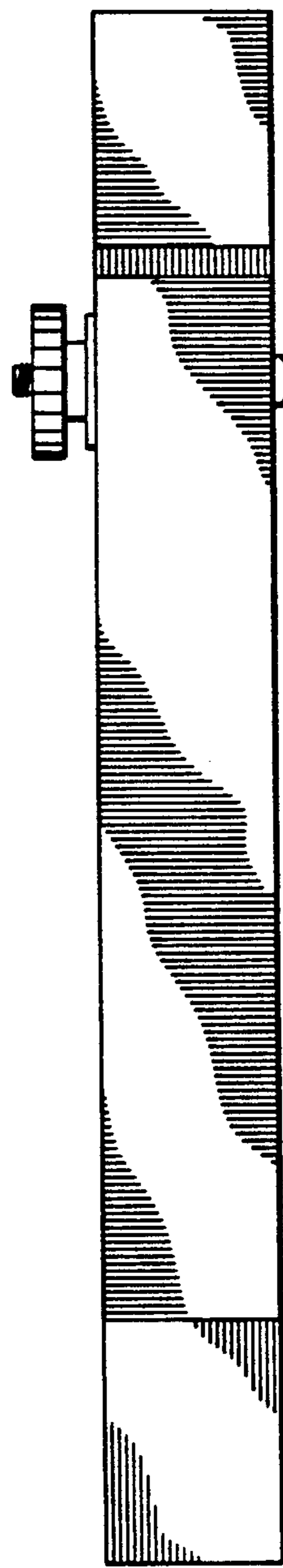

FIG. 7

