



US00D334750S

# United States Patent [19]

Negishi et al.

[11] Patent Number: **Des. 334,750**

[45] Date of Patent: **\*\* Apr. 13, 1993**

## [54] LOUDSPEAKER

[75] Inventors: **Hirokazu Negishi**, Guildford, England; **Allen Boothroyd**, Little Shelford, United Kingdom

[73] Assignee: **Canon Research Centre Europe Limited**, Surrey, England

[\*\*] Term: **14 Years**

[21] Appl. No.: **649,826**

[22] Filed: **Feb. 1, 1991**

### [30] Foreign Application Priority Data

Aug. 3, 1990 [GB]	United Kingdom	2008719
[52] U.S. Cl.		<b>D14/213; D14/216</b>
[58] Field of Search		<b>D14/204, 207-216, D14/219-222; 181/144, 145, 148, 150, 153, 199; 381/87-90</b>

### [56] References Cited

#### U.S. PATENT DOCUMENTS

D. 247,490	3/1978	Everidge	D14/212
D. 292,702	11/1987	White et al.	D14/212
D. 302,817	8/1989	Macaulay	D14/214
D. 303,970	10/1989	Collins et al.	D14/216
3,765,504	10/1973	Itoh	183/31
3,976,838	8/1976	Stallings	179/1
4,357,490	11/1982	Dickey	179/1
5,115,882	5/1992	Woody	181/144

## FOREIGN PATENT DOCUMENTS

0320270	6/1989	European Pat. Off.
774167	2/1956	United Kingdom
1316771	5/1973	United Kingdom
1348535	3/1974	United Kingdom
2007461	5/1979	United Kingdom
2184323	6/1987	United Kingdom
2188811	10/1987	United Kingdom
2215166	9/1989	United Kingdom
2226214	6/1990	United Kingdom

## OTHER PUBLICATIONS

Stereo Review Apr. 1988 Back Cover B&W speaker, right side.

*Primary Examiner*—Bernard Ansher

*Assistant Examiner*—Sandra Morris

*Attorney, Agent, or Firm*—Fitzpatrick, Cella, Harper & Scinto

## [57] CLAIM

The ornamental design for a loudspeaker, as shown and described.

## DESCRIPTION

FIG. 1 is a front view of a loudspeaker showing our new design;

FIG. 2 is a top plan view thereof;

FIG. 3 is a rear view thereof;

FIG. 4 is an underneath plan view thereof;

FIG. 5 is a right side elevational view thereof; and,

FIG. 6 is a rear perspective view thereof.

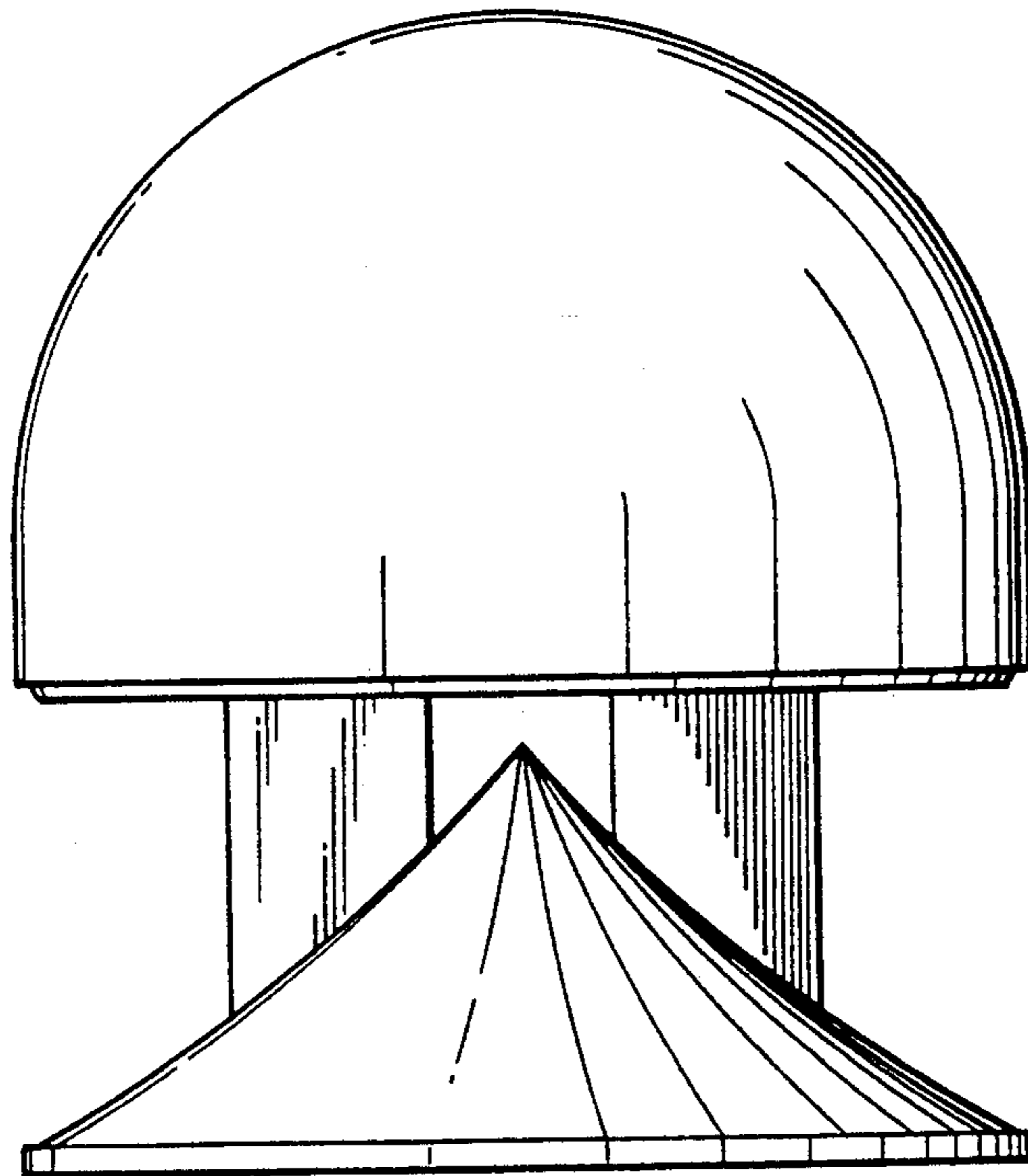

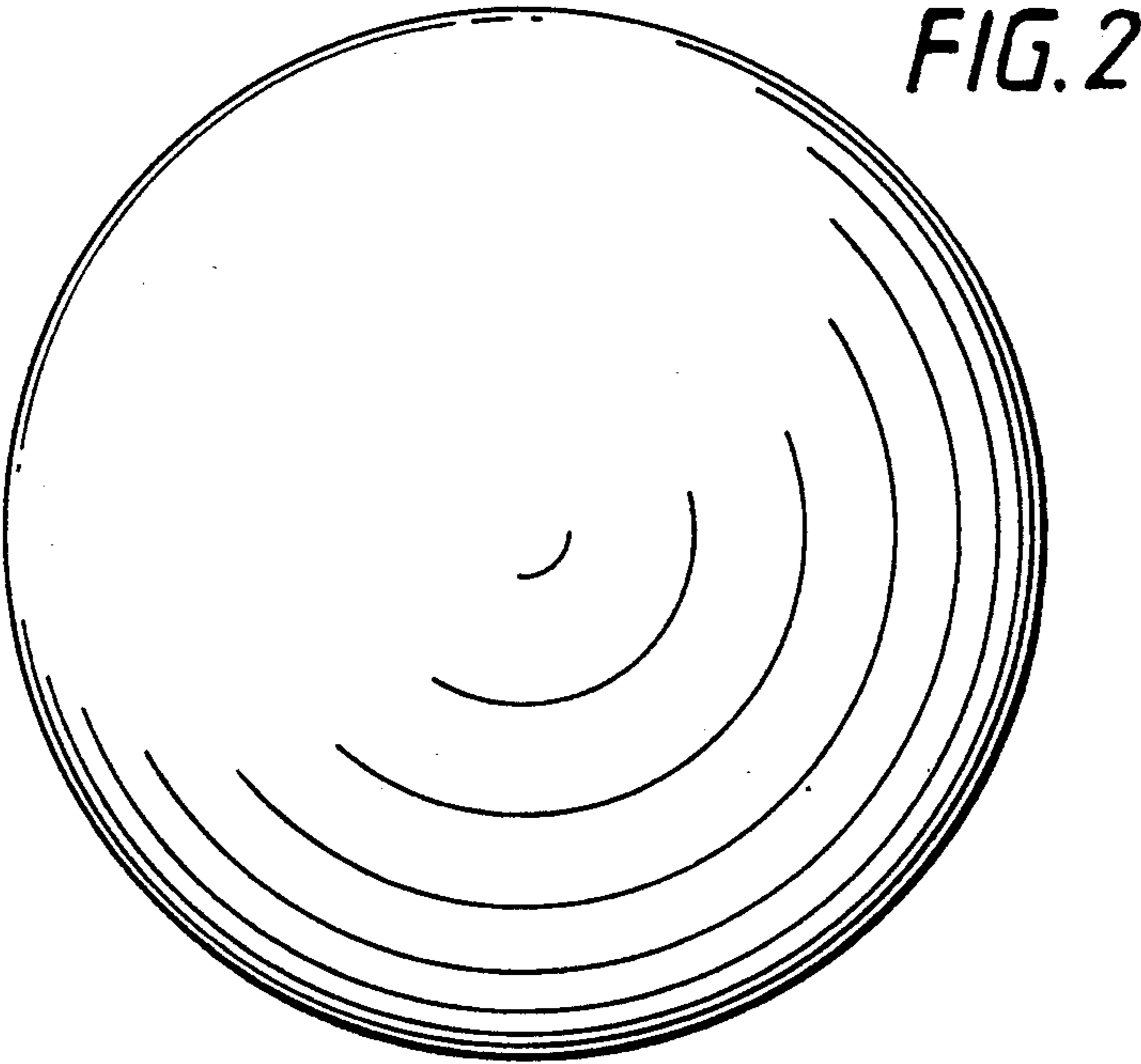
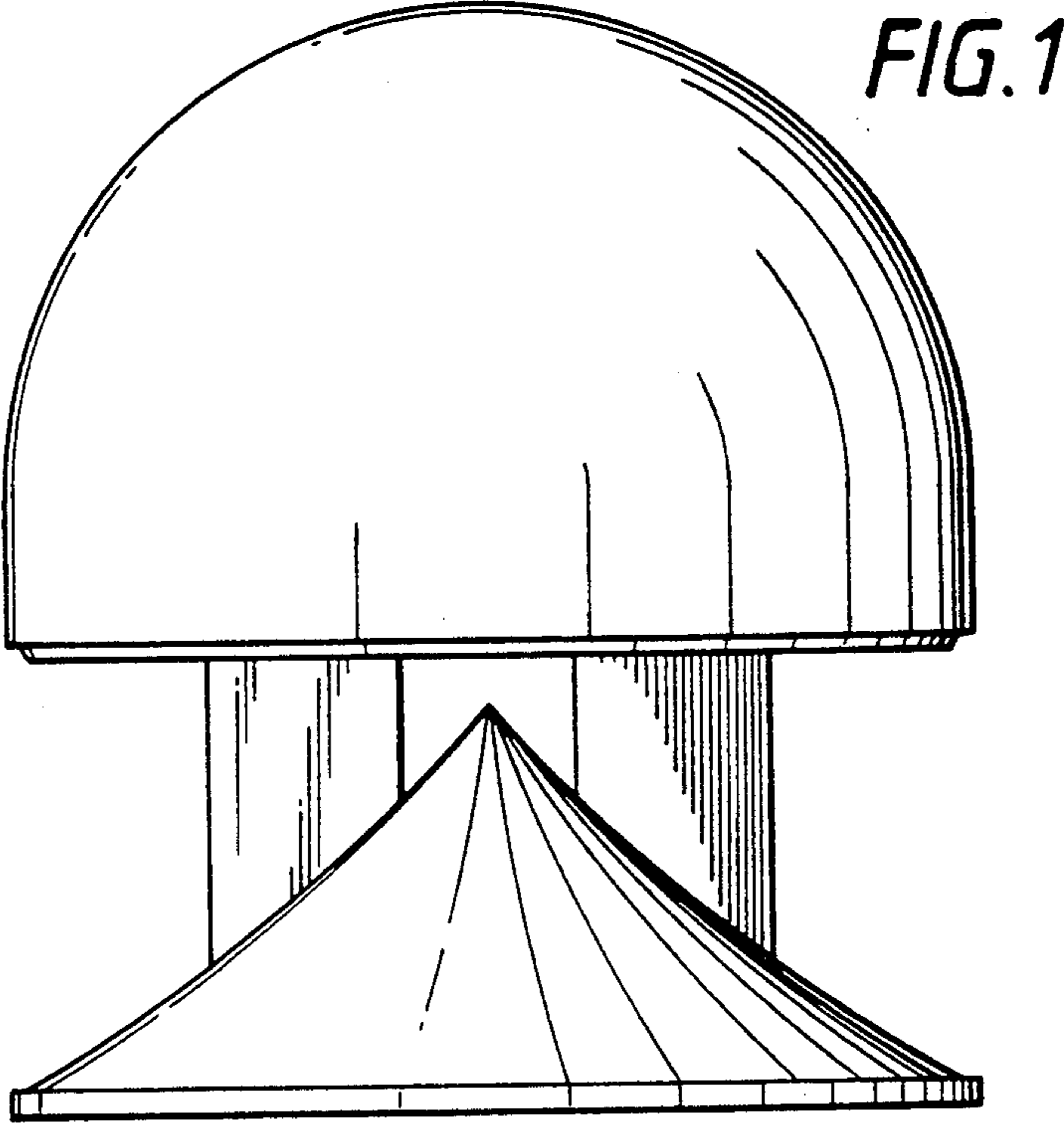

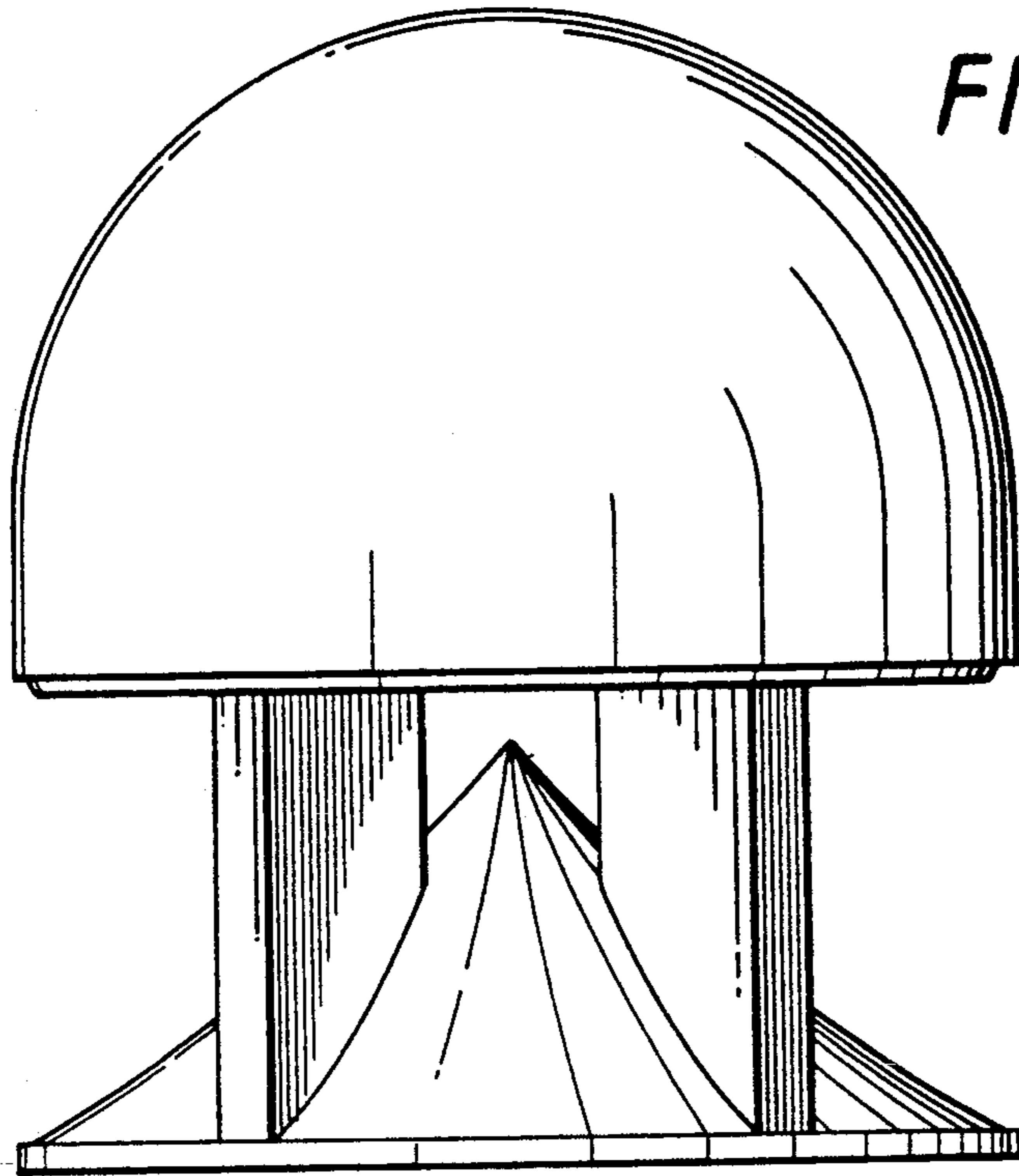

FIG. 3

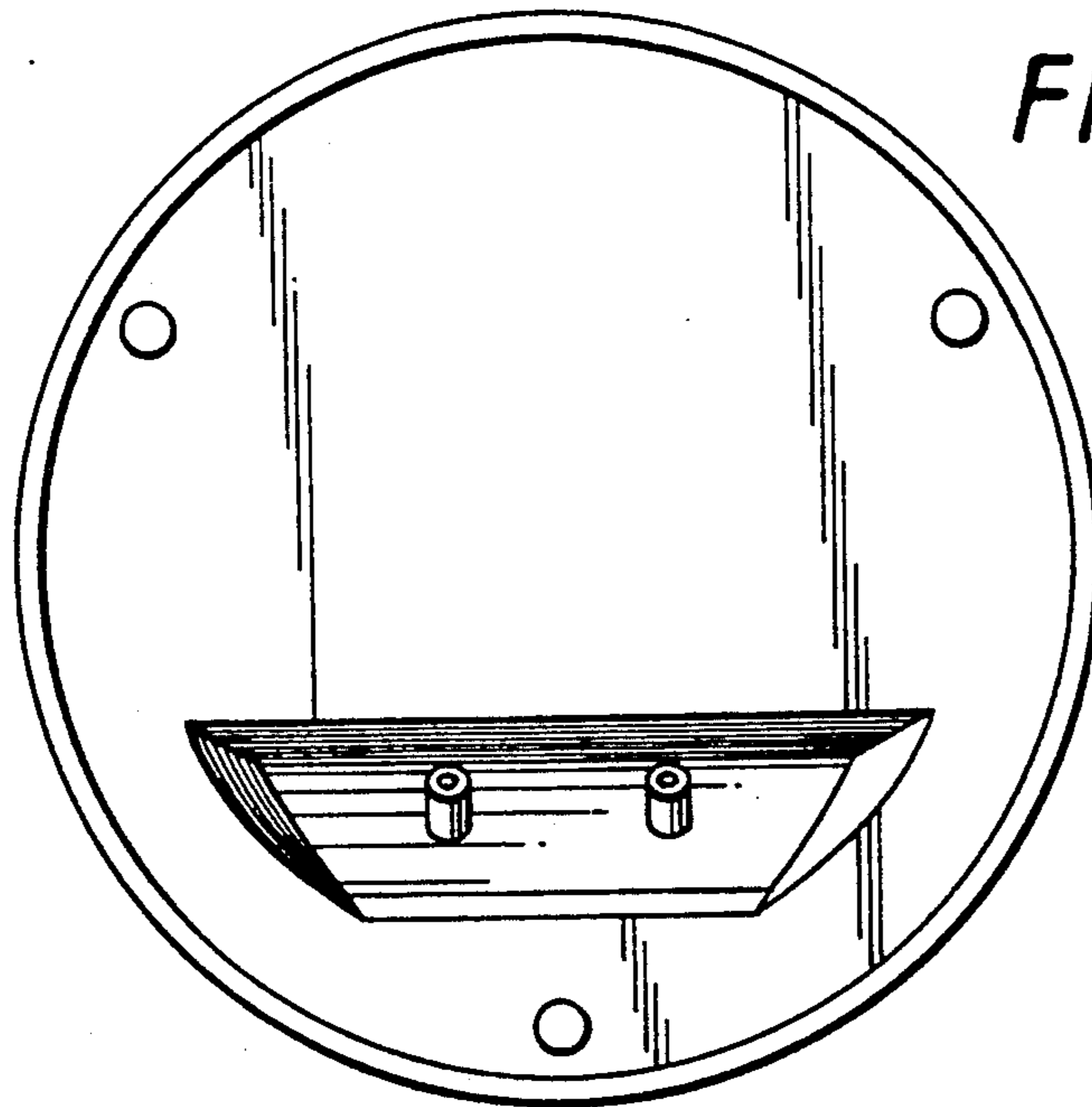
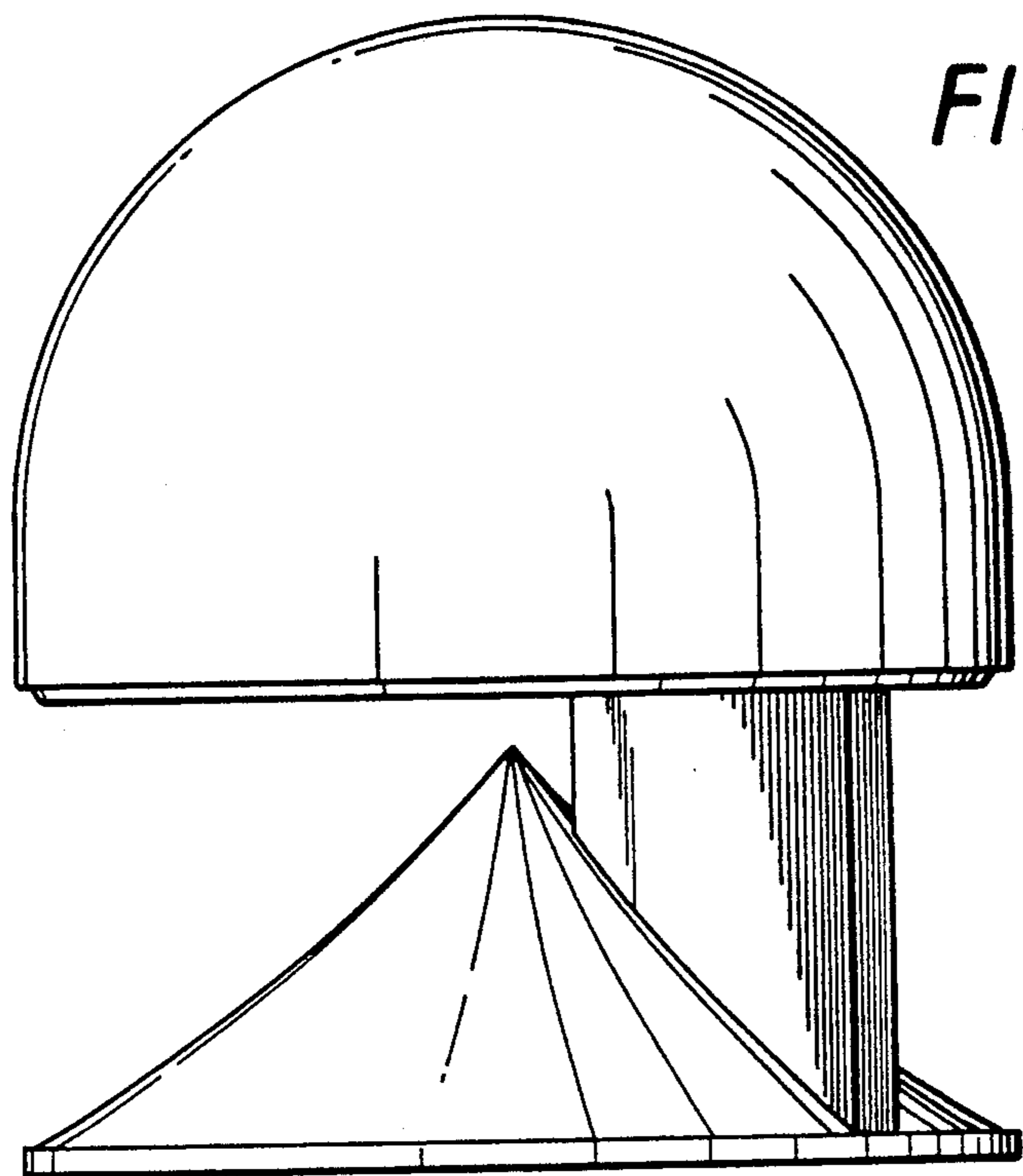
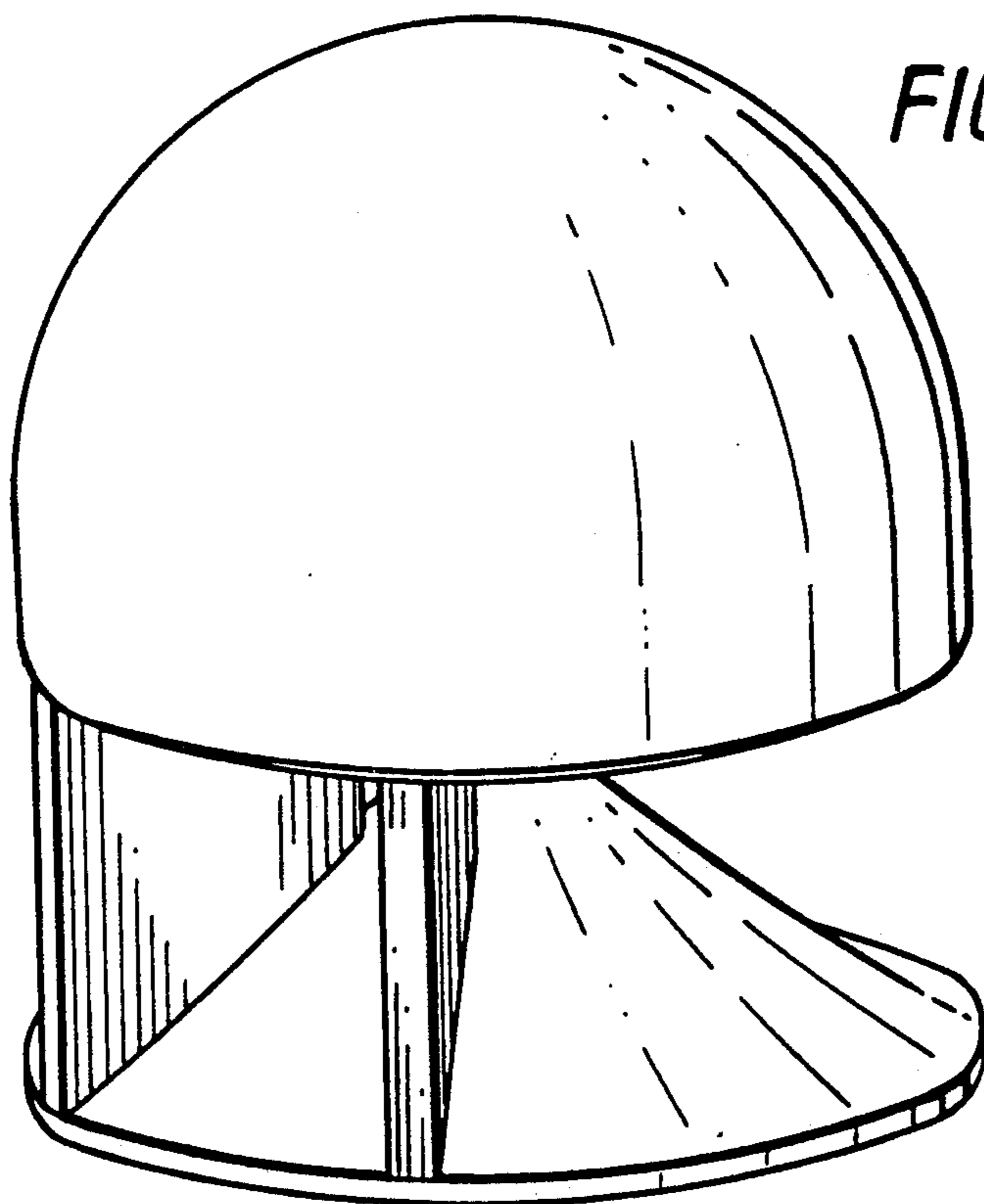

FIG. 4



*FIG. 5*



*FIG. 6*