



US00D334728S

United States Patent [19]

[11] Patent Number: **Des. 334,728**

Ishiyama et al.

[45] Date of Patent: **** Apr. 13, 1993**

[54] **PORTABLE PLANTER FOR GROWING SMALL PLANTS**

3,177,616 4/1965 Sawyer 47/14
3,606,697 9/1971 Eden 47/19

[75] Inventors: **Shozo Ishiyama; Takeshi Kubodera; Takako Inose**, all of Tokyo, Japan

Primary Examiner—B. J. Bullock
Attorney, Agent, or Firm—Merchant, Gould, Smith, Edell, Welter & Schmidt

[73] Assignee: **Kabushiki Kaisha Gakushu Kenkyusha**, Tokyo, Japan

[57] **CLAIM**

[**] Term: **14 Years**

The ornamental design for a portable planter for growing small plants, as shown and described.

[21] Appl. No.: **539,962**

DESCRIPTION

[22] Filed: **Jun. 14, 1990**

[30] **Foreign Application Priority Data**

Mar. 23, 1990 [JP] Japan 2-9762

[52] U.S. Cl. **D11/155**

[58] Field of Search D11/143, 155, 156, 145;
D3/74; 47/14, 19, 61, 79

FIG. 1 is a top plan view of a portable planter for growing small plants showing our new design;
FIG. 2 is a side elevational view taken from the top of FIG. 1, the side opposite being a mirror image;
FIG. 3 is an end elevational view taken from the left of FIG. 1;
FIG. 4 is an end elevational view taken from the right of FIG. 1;
FIG. 5 is a bottom plan view thereof;
FIG. 6 is a sectional view taken in the direction of the arrows on line 6—6 of FIG. 1;
FIG. 7 is a sectional view taken in the direction of the arrows on line 7—7 of FIG. 1; and,
FIG. 8 is an exploded perspective view thereof.

[56] **References Cited**

U.S. PATENT DOCUMENTS

D. 239,307 3/1976 Sawyer D11/156
2,722,778 11/1955 Carufel D11/156
2,798,335 7/1957 Downey 47/79
3,106,801 10/1963 Risacher 47/19

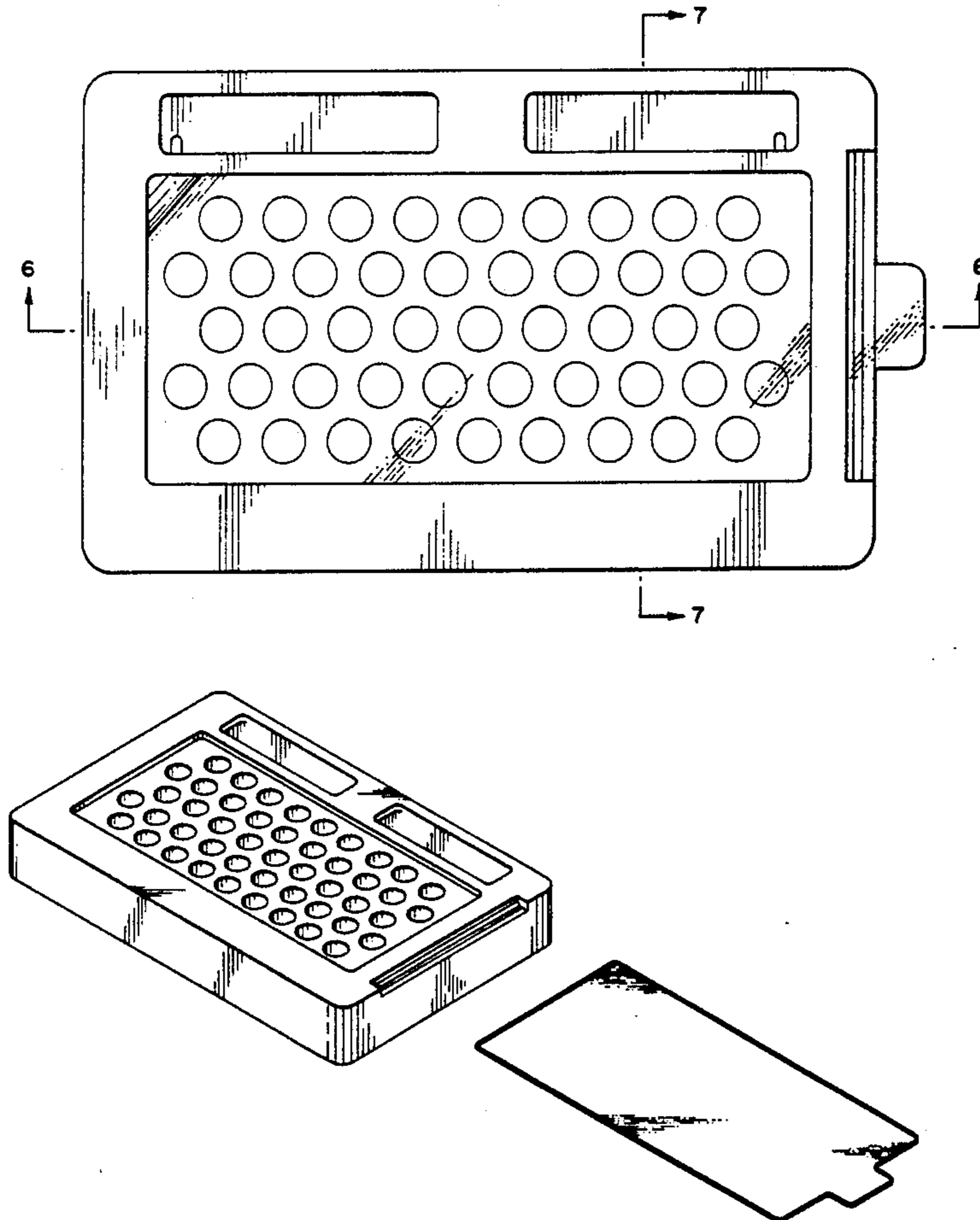

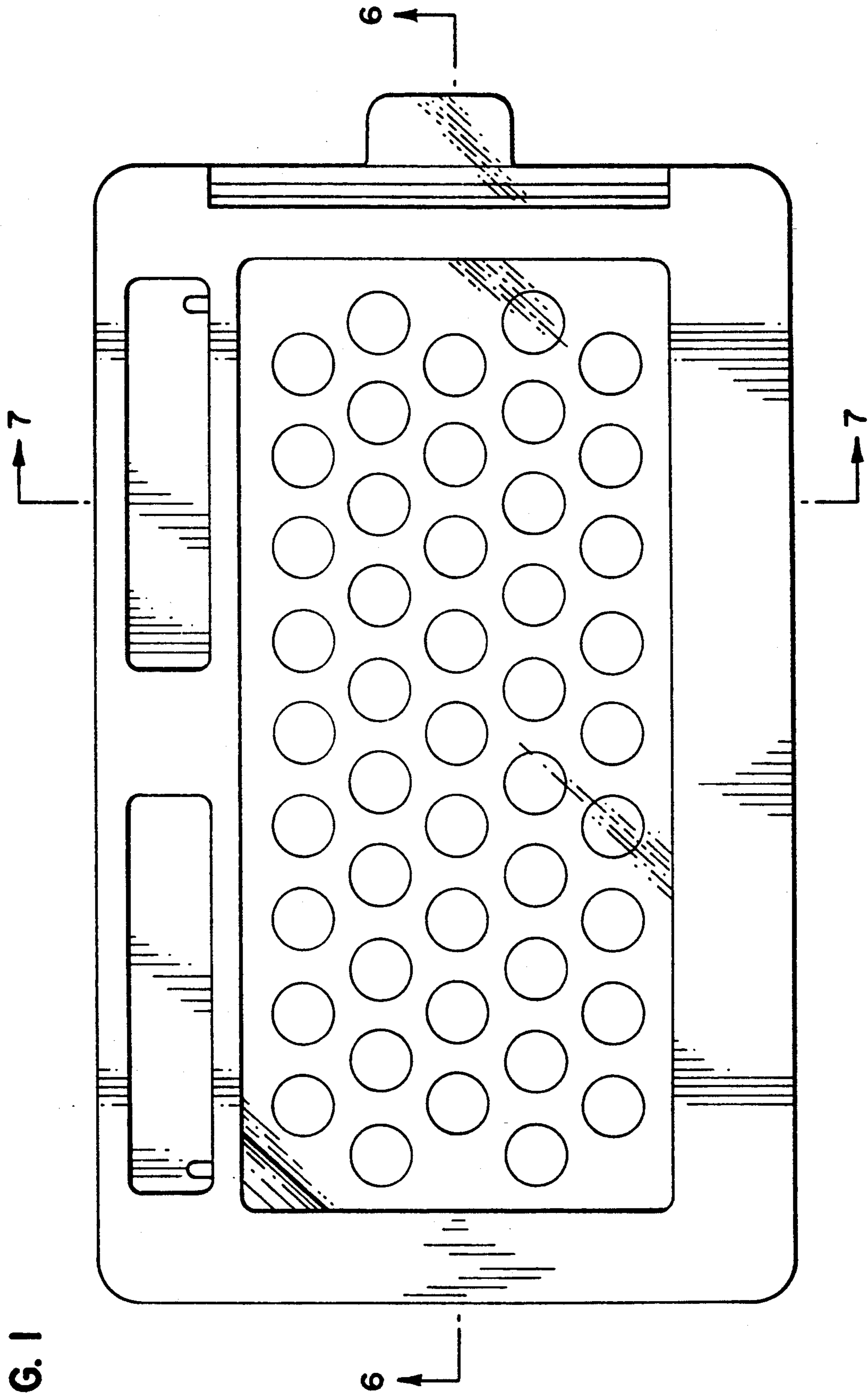

FIG. 1

FIG. 2

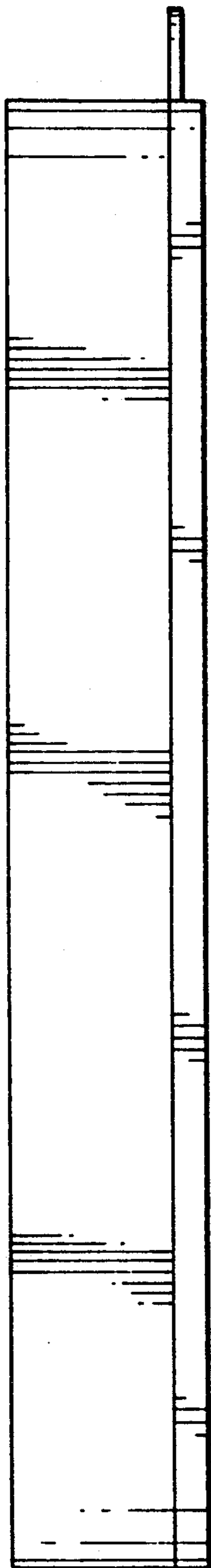

FIG. 6

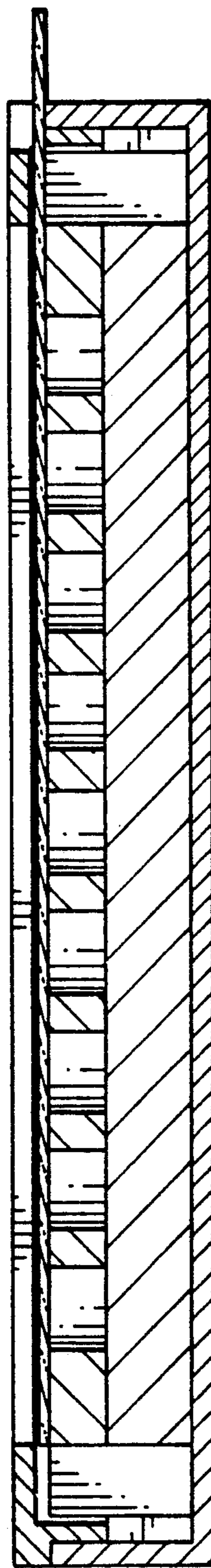

FIG. 7

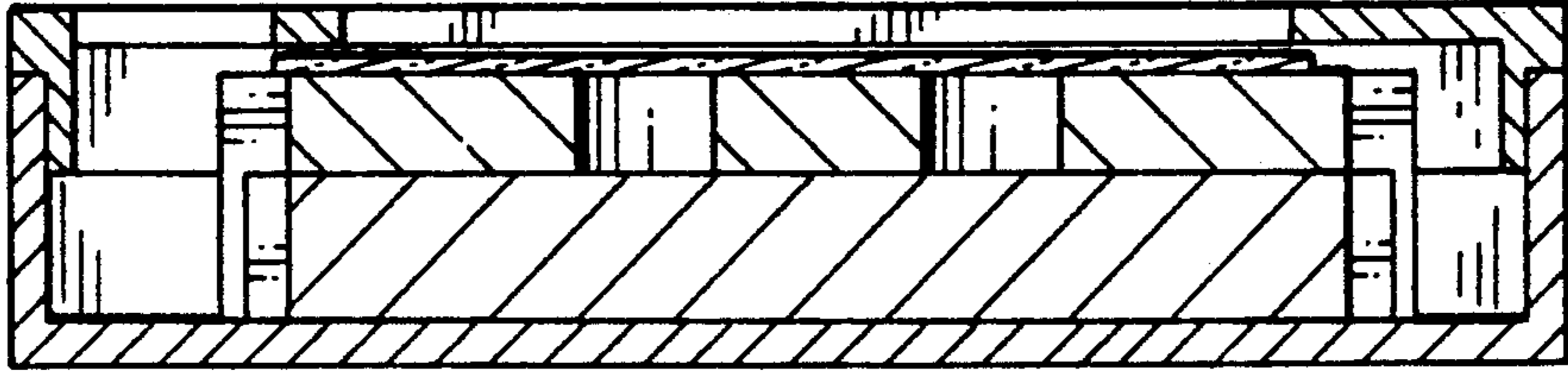

FIG. 4

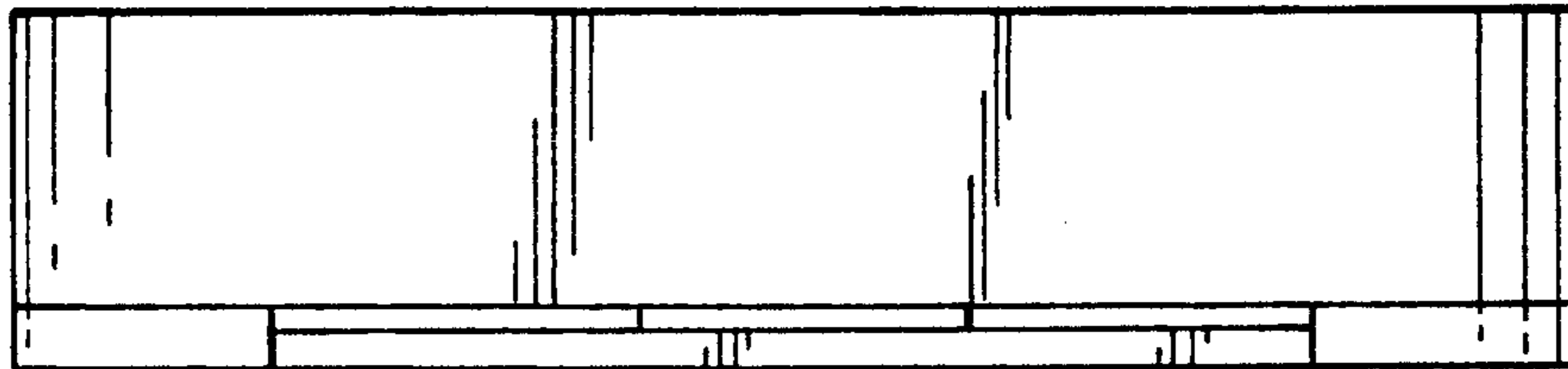
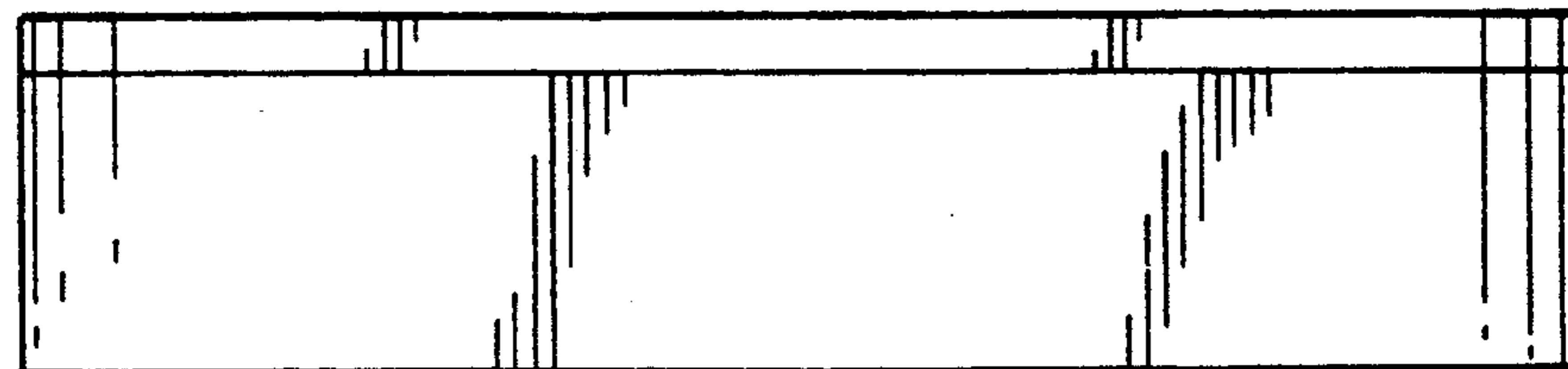

FIG. 3



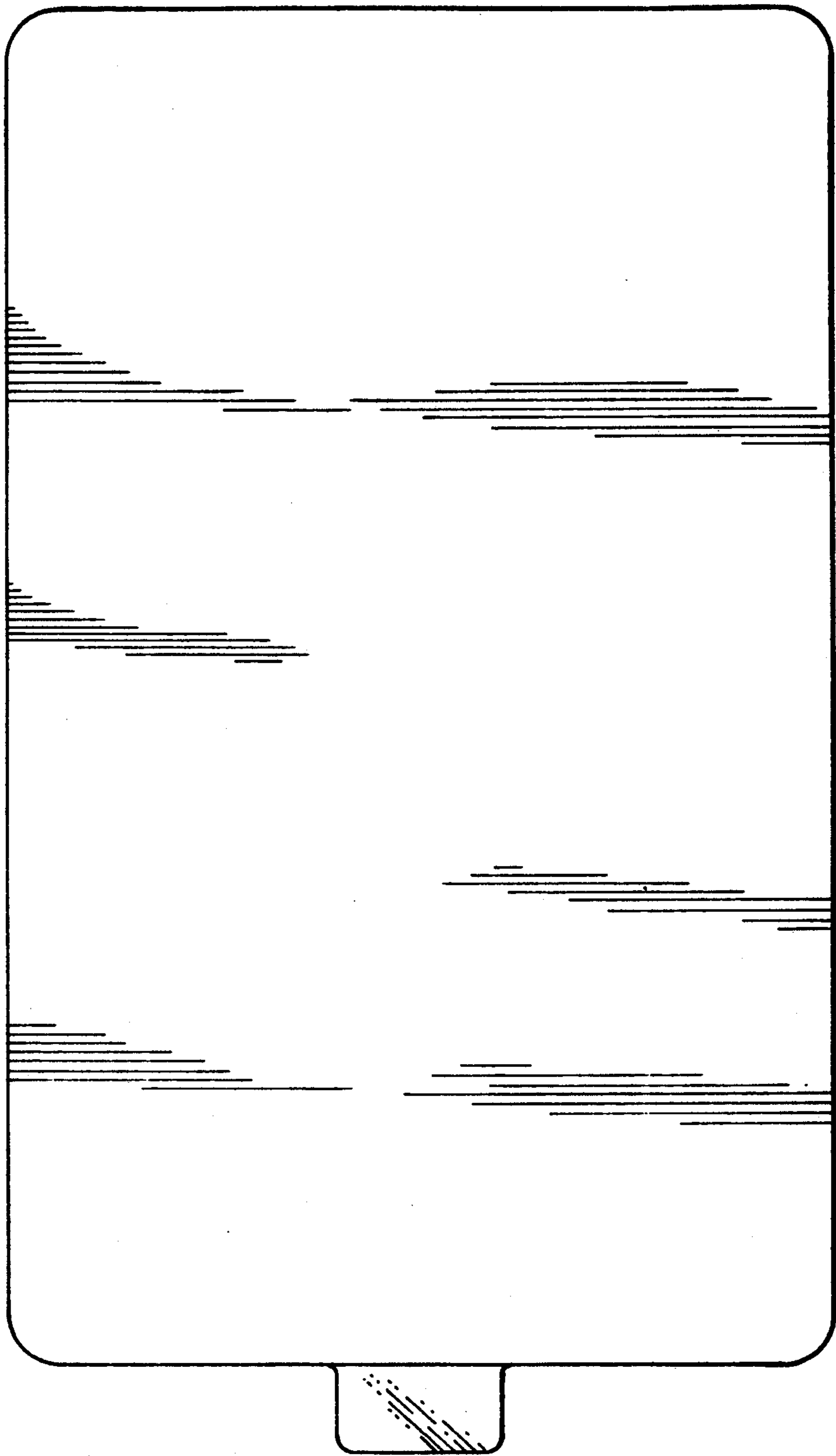

FIG. 5

FIG. 8

