



US00D334611S

# United States Patent [19]

[11] Patent Number: **Des. 334,611**

**Mariol**

[45] Date of Patent: **\*\* Apr. 6, 1993**

[54] **TEETER TOTTER TOY**

[75] Inventor: **James F. Mariol, Cincinnati, Ohio**

[73] Assignee: **The Little Tikes Company, Hudson, Ohio**

[\*\*] Term: **14 Years**

[21] Appl. No.: **582,550**

[22] Filed: **Sep. 14, 1990**

[52] U.S. Cl. .... **D21/251**

[58] Field of Search ..... **D21/251, 240, 66, 68, D21/87, 90; 472/106-115, 130**

[56] **References Cited**

**U.S. PATENT DOCUMENTS**

D. 54,879	4/1920	Wuyckhuysse .....	D21/68
D. 211,650	7/1968	Harness .....	D21/551
D. 261,762	11/1981	Ament et al. ....	D21/551
D. 312,293	11/1990	Wehmeyer .....	D21/251
624,832	5/1899	Lowrey .....	472/112
4,896,877	1/1990	Moomaw et al. ....	472/106 X

**OTHER PUBLICATIONS**

Mexico Forge, Jun. 1984, p. 27, Broncos See Saw.  
Game-Time, 1965, p. 16, Buck-a-Boot See Saw.  
P. 55, Fisher-Price, Division of The Quaker Oats Company, 620 Girard Avenue, East Aurora, New York 14052-1879.  
Pp. 62 and 68, The Little Tikes Company, 2180 Barlow Road, Hudson, Ohio 44236. Publication date 1990.

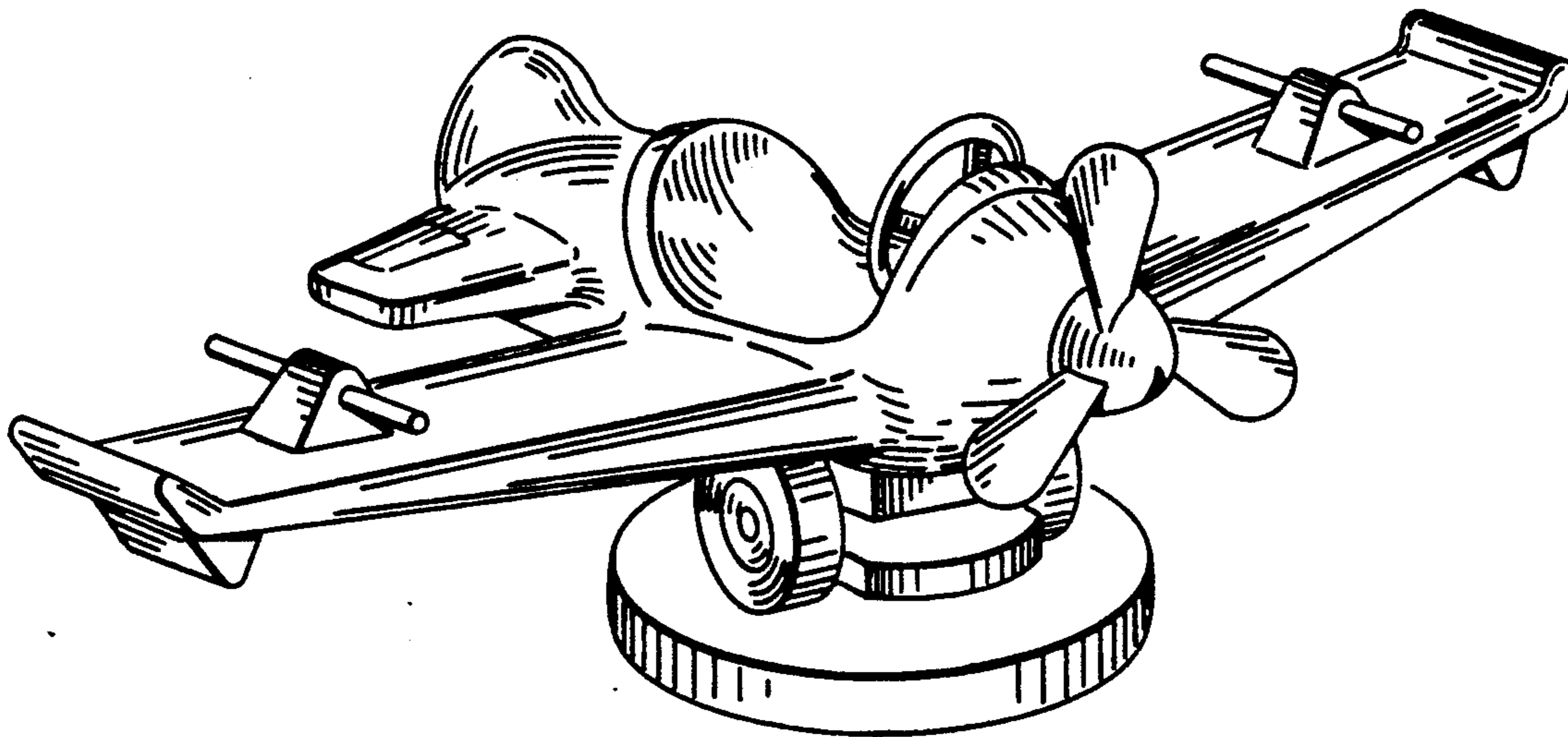
*Primary Examiner*—Bernard Ansher  
*Assistant Examiner*—Prabhakar Deshmukh  
*Attorney, Agent, or Firm*—Richard B. O'Planick

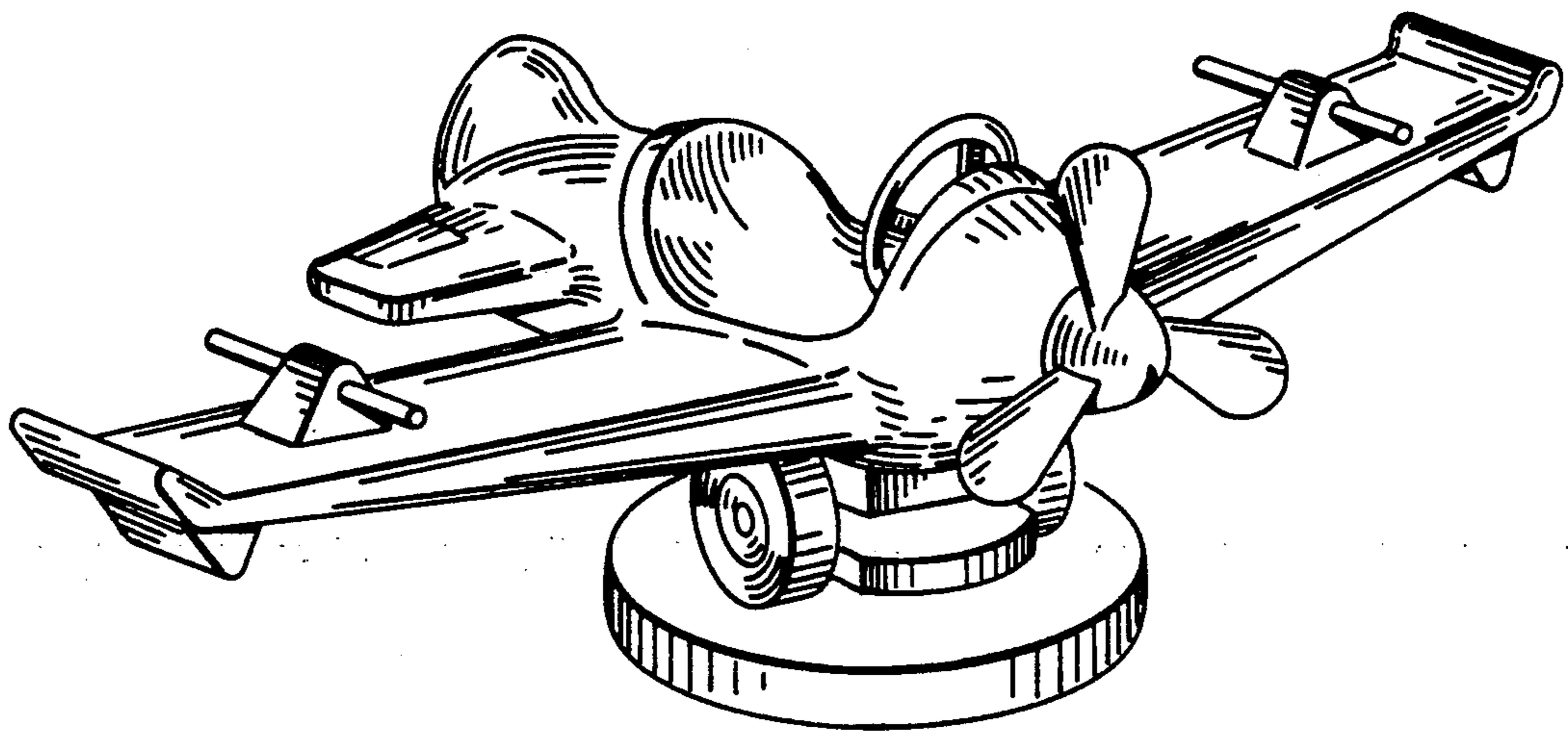
[57] **CLAIM**

The ornamental design for a teeter totter toy, as shown and described.

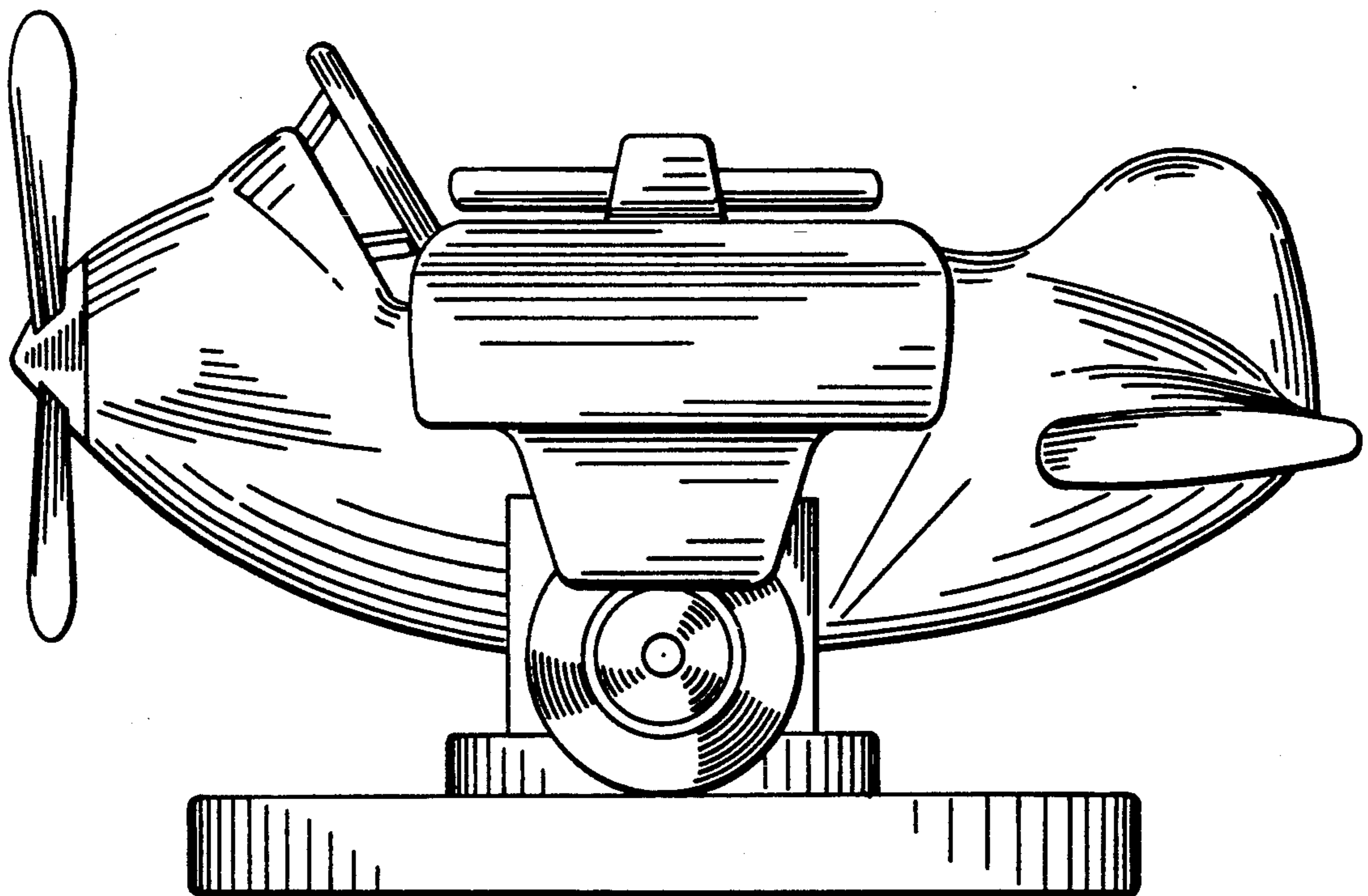
**DESCRIPTION**

FIG. 1 is a left front perspective view of a teeter totter toy embodying my new design;  
FIG. 2 is a right side elevational view thereof; the left side being a mirror image;  
FIG. 3 is a top plan view thereof;  
FIG. 4 is a front elevational view thereof;  
FIG. 5 is a bottom plan view thereof; and,  
FIG. 6 is a rear elevational view thereof.

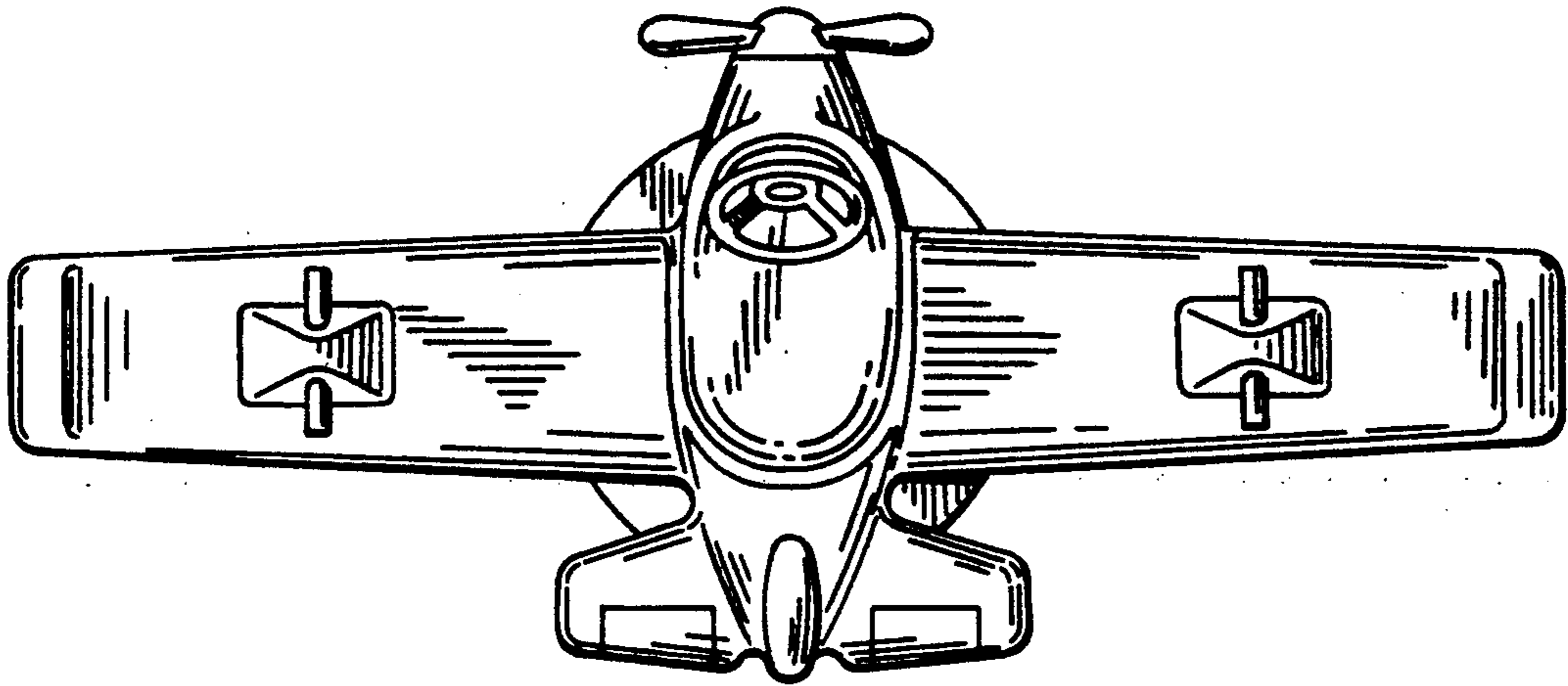




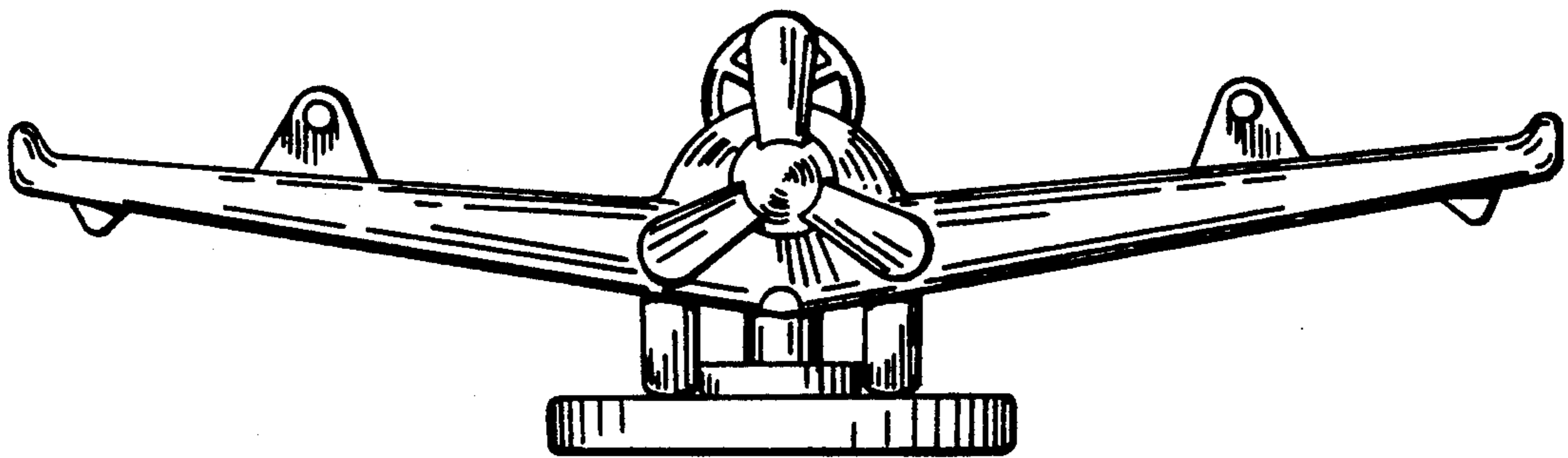
*FIG. 1*



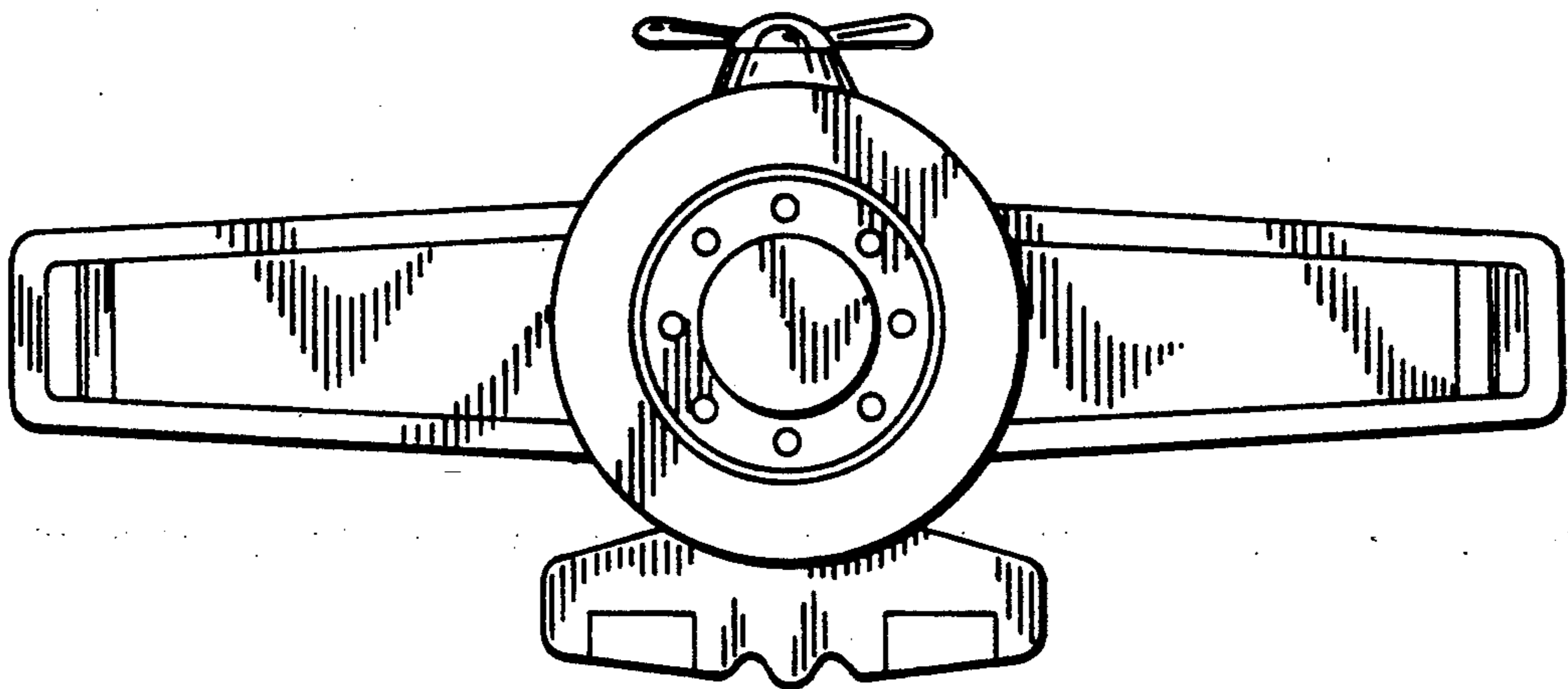
*FIG. 2*



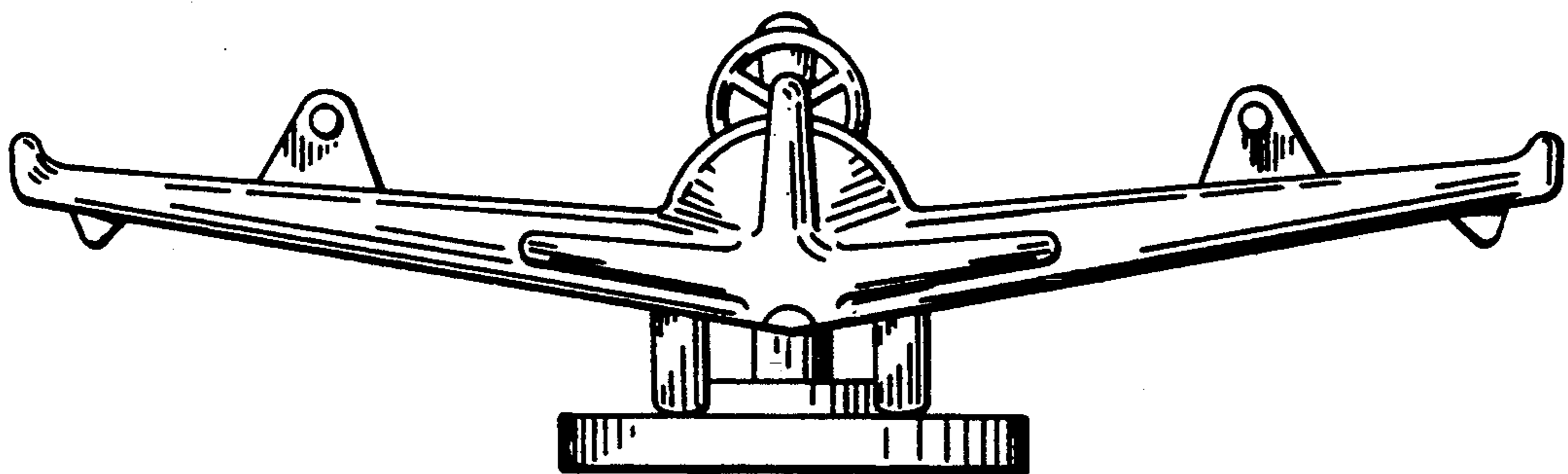
*FIG. 3*



*FIG. 4*



*FIG. 5*



*FIG. 6*