



US00D334529S

United States Patent [19]

[11] Patent Number: **Des. 334,529**

Guilbert

[45] Date of Patent: **** Apr. 6, 1993**

[54] **GARDEN HOSE HOLDER**

2,003,837	6/1935	Skoglund	248/83
2,934,210	4/1960	Jordan	D6/462 X
3,021,102	2/1962	Kuempel	248/80 X

[76] Inventor: **Peter A. Guilbert**, 7049 Solomon Seal Ct., Springfield, Va. 22152

[**] Term: **14 Years**

[21] Appl. No.: **627,374**

[22] Filed: **Dec. 14, 1990**

[52] U.S. Cl. **D8/356; D6/462; D6/466; D7/619**

[58] Field of Search **D6/396, 449, 462, 466, D6/475; D7/616-620; D8/356, 373; 211/181, 13; 248/80-88**

OTHER PUBLICATIONS

Modern Mechanix & Inventions, Nov. 1934, p. 101, item—Garden Hose Holder.

Primary Examiner—Alan P. Douglas
Assistant Examiner—Jeffrey Asch
Attorney, Agent, or Firm—Leon Gilden

[57] **CLAIM**

The ornamental design for a garden hose holder, as shown and described.

[56] **References Cited**

U.S. PATENT DOCUMENTS

D. 228,529	10/1973	Bates	D7/619 X
D. 281,221	11/1985	Edmiston	D8/356
D. 290,794	7/1987	Mingledorff, Jr.	D6/462
D. 290,809	7/1987	Elliot	D8/356
D. 317,861	7/1991	Lechner	D6/462 X
1,590,910	6/1926	Rumrill	248/80
1,596,752	8/1926	Mitchell	248/85
1,906,380	5/1933	Johnson	248/80

DESCRIPTION

FIG. 1 is a front elevational view of the garden hose holder showing my new design;
FIG. 2 is a rear elevational view thereof;
FIG. 3 is a left side elevational view thereof;
FIG. 4 is a right side elevational view thereof;
FIG. 5 is a top plan view thereof;
FIG. 6 is a bottom plan view thereof; and,
FIG. 7 is a perspective view thereof.

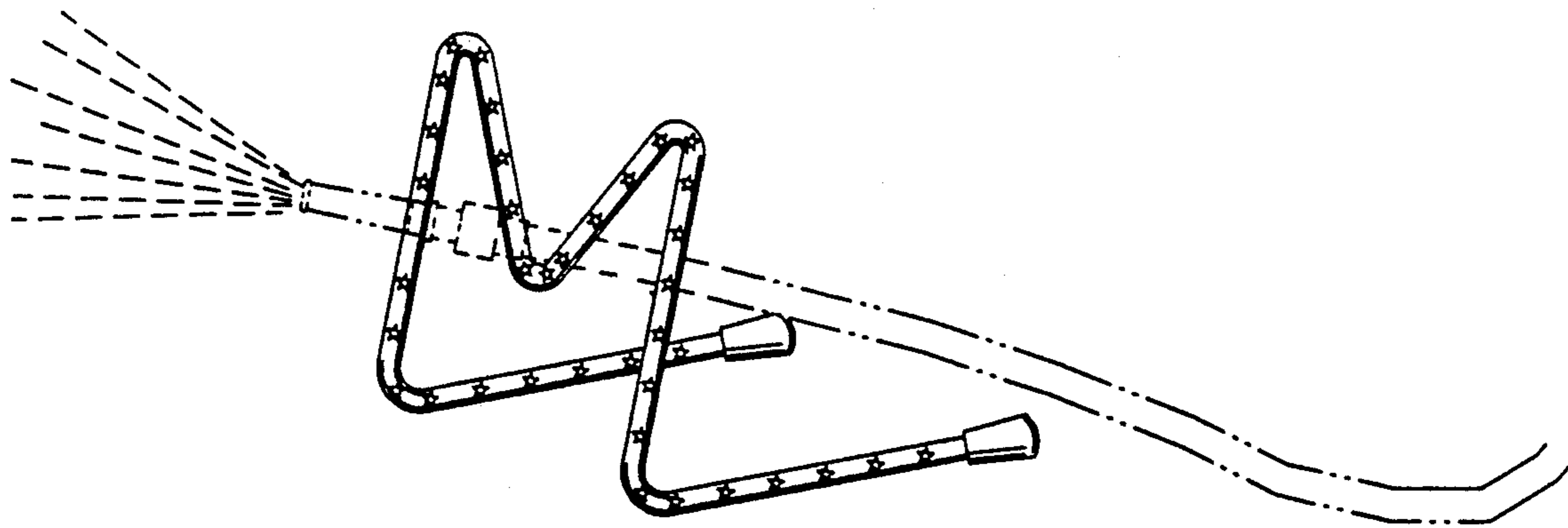

FIG. 1

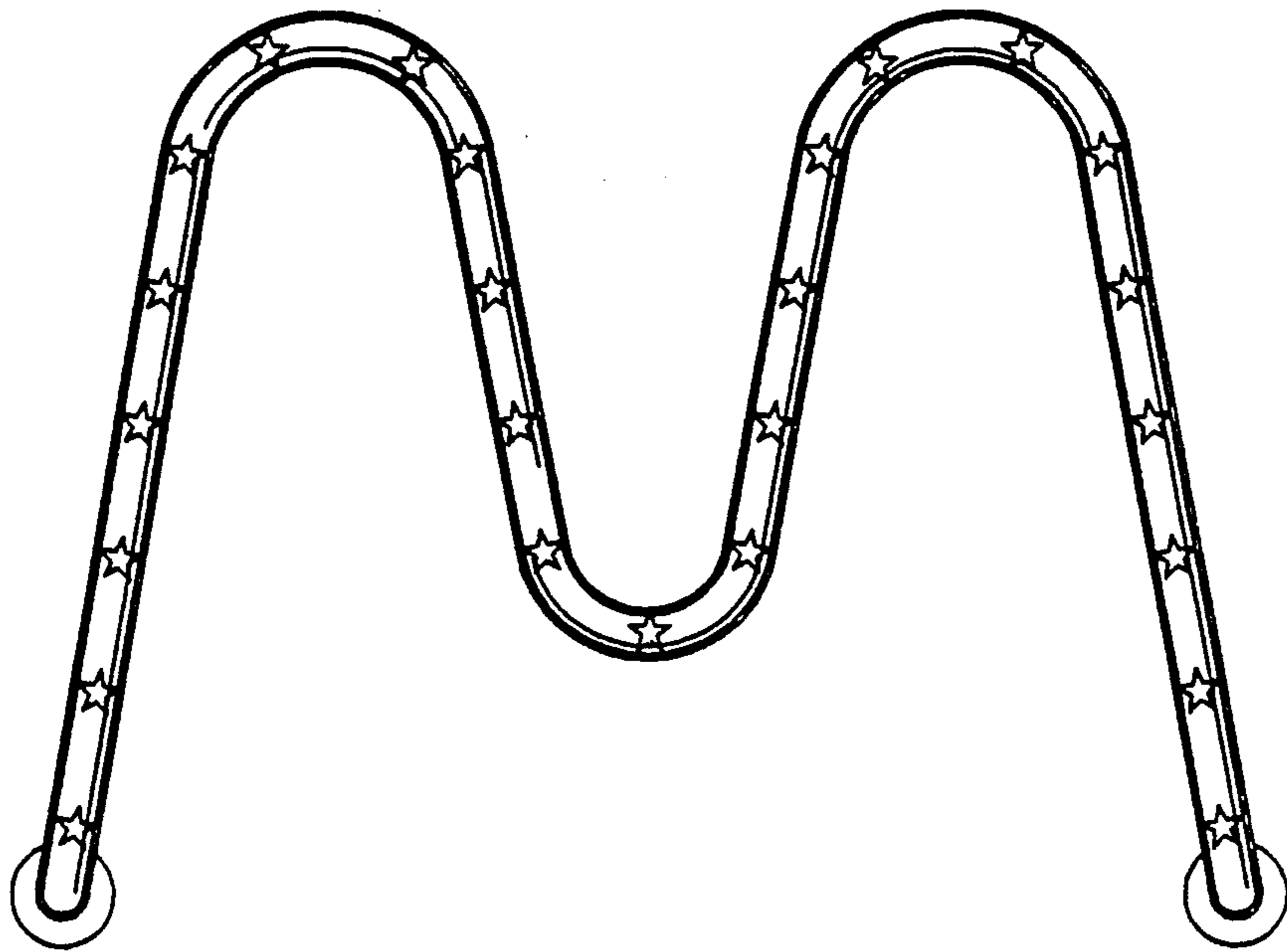

FIG. 2

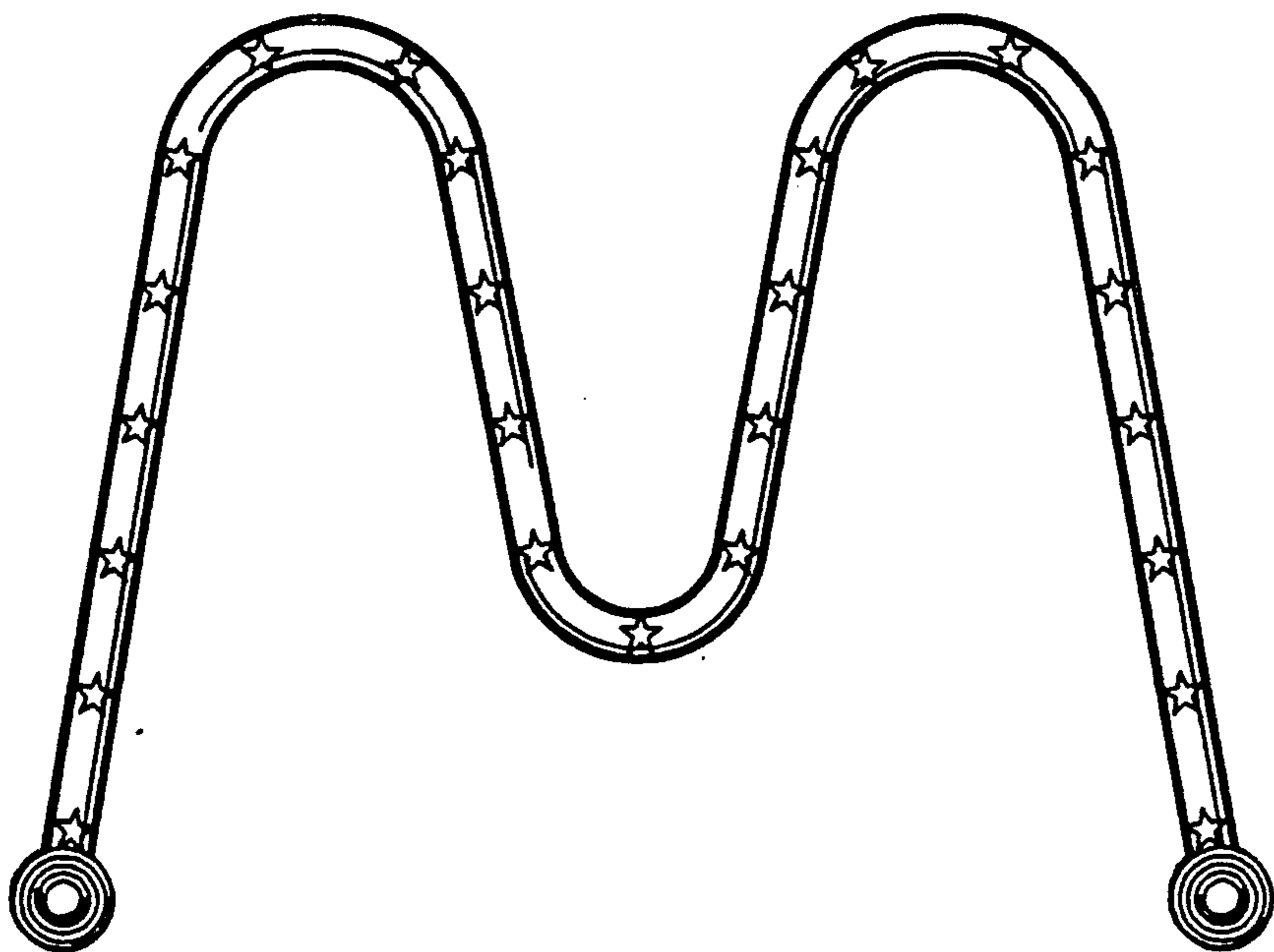

FIG. 3

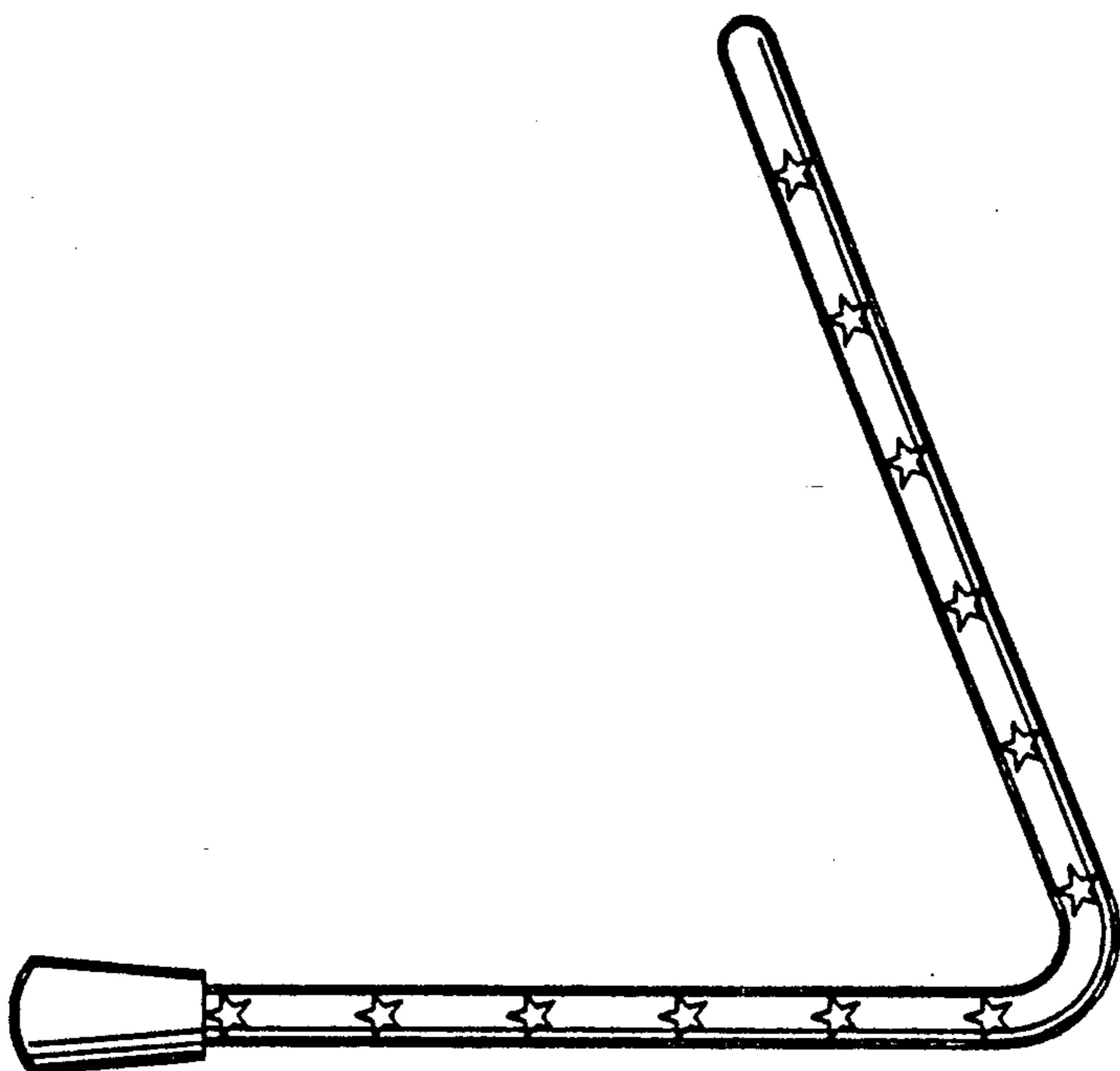

FIG. 4

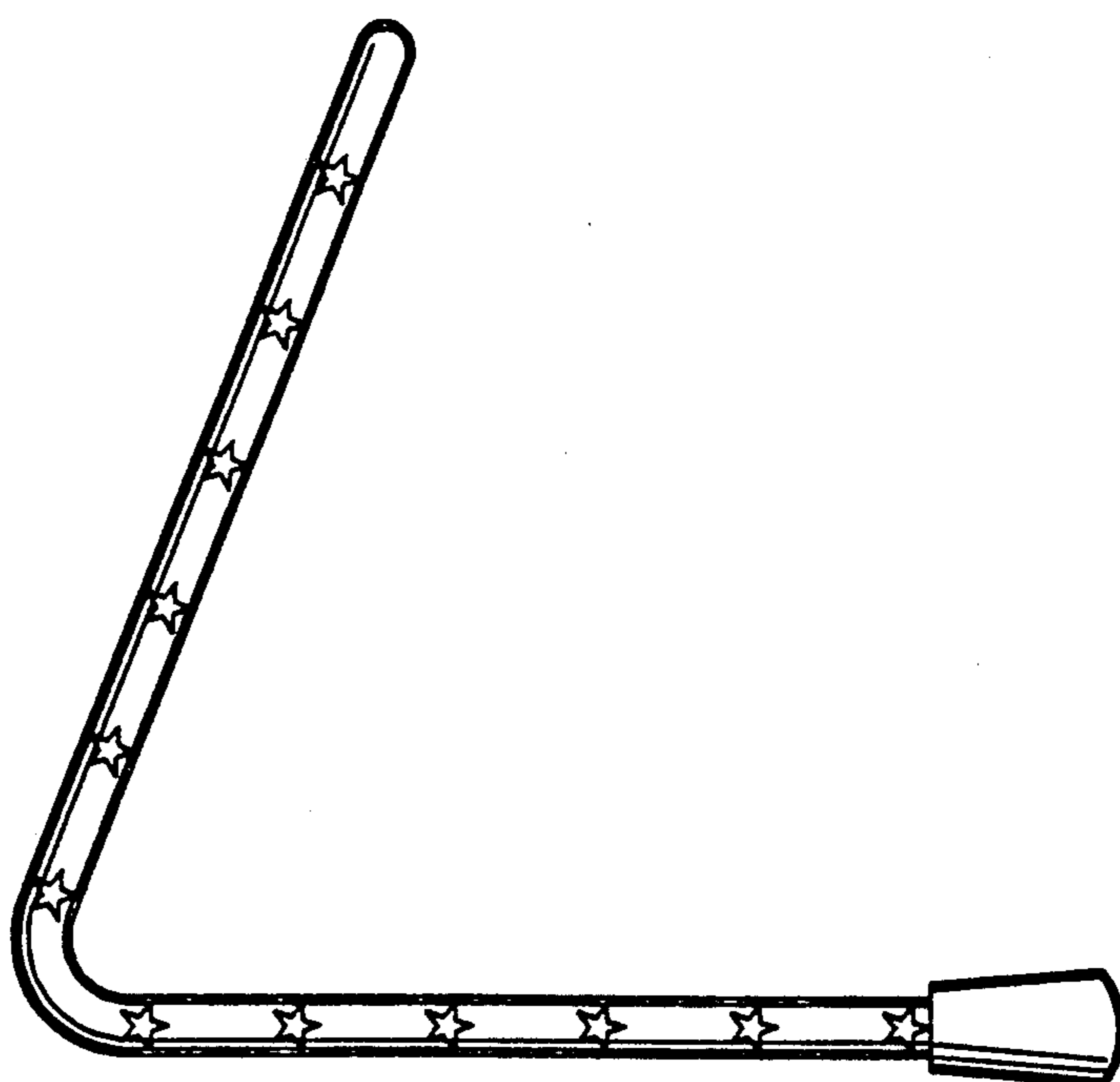

FIG. 5

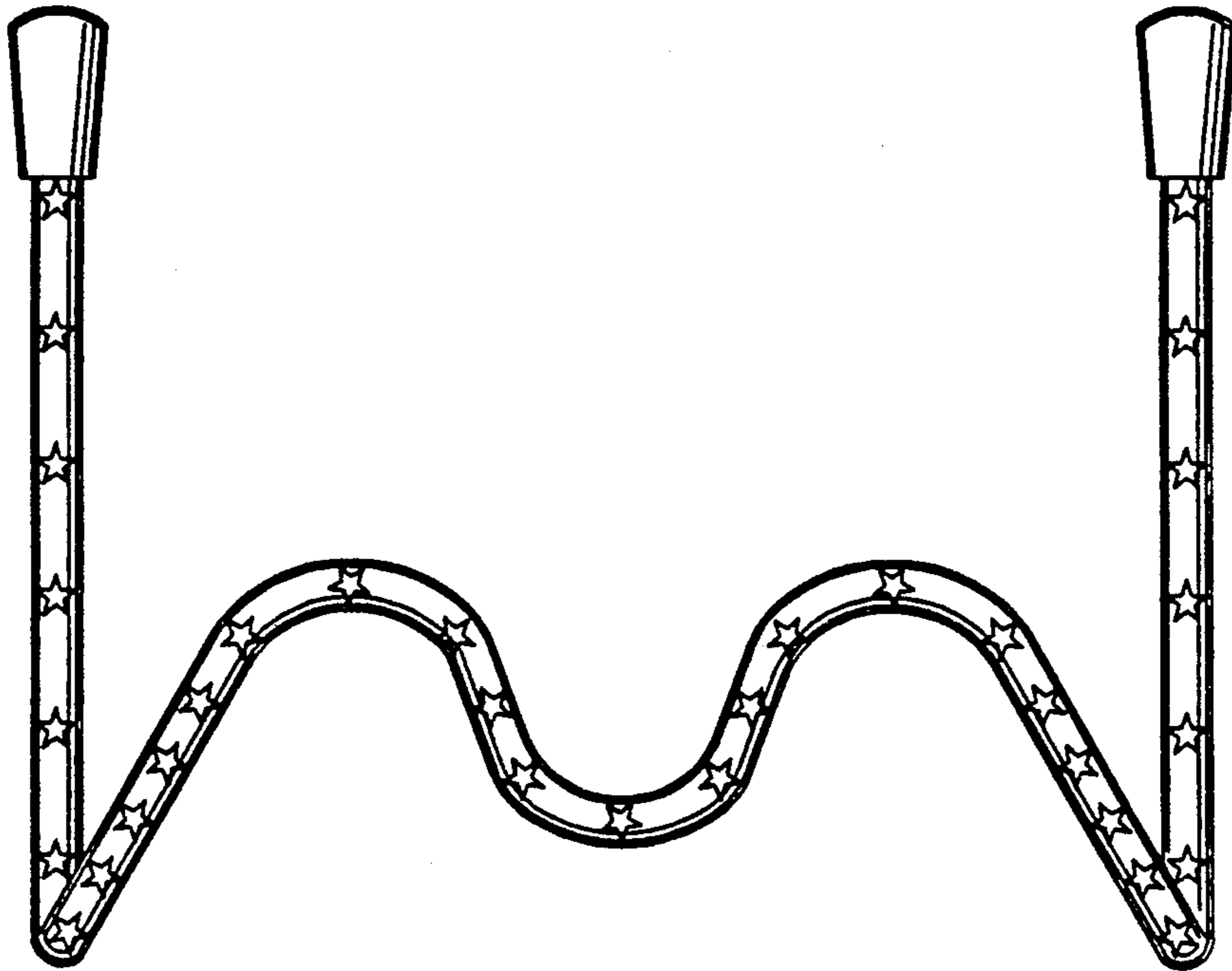

FIG. 6

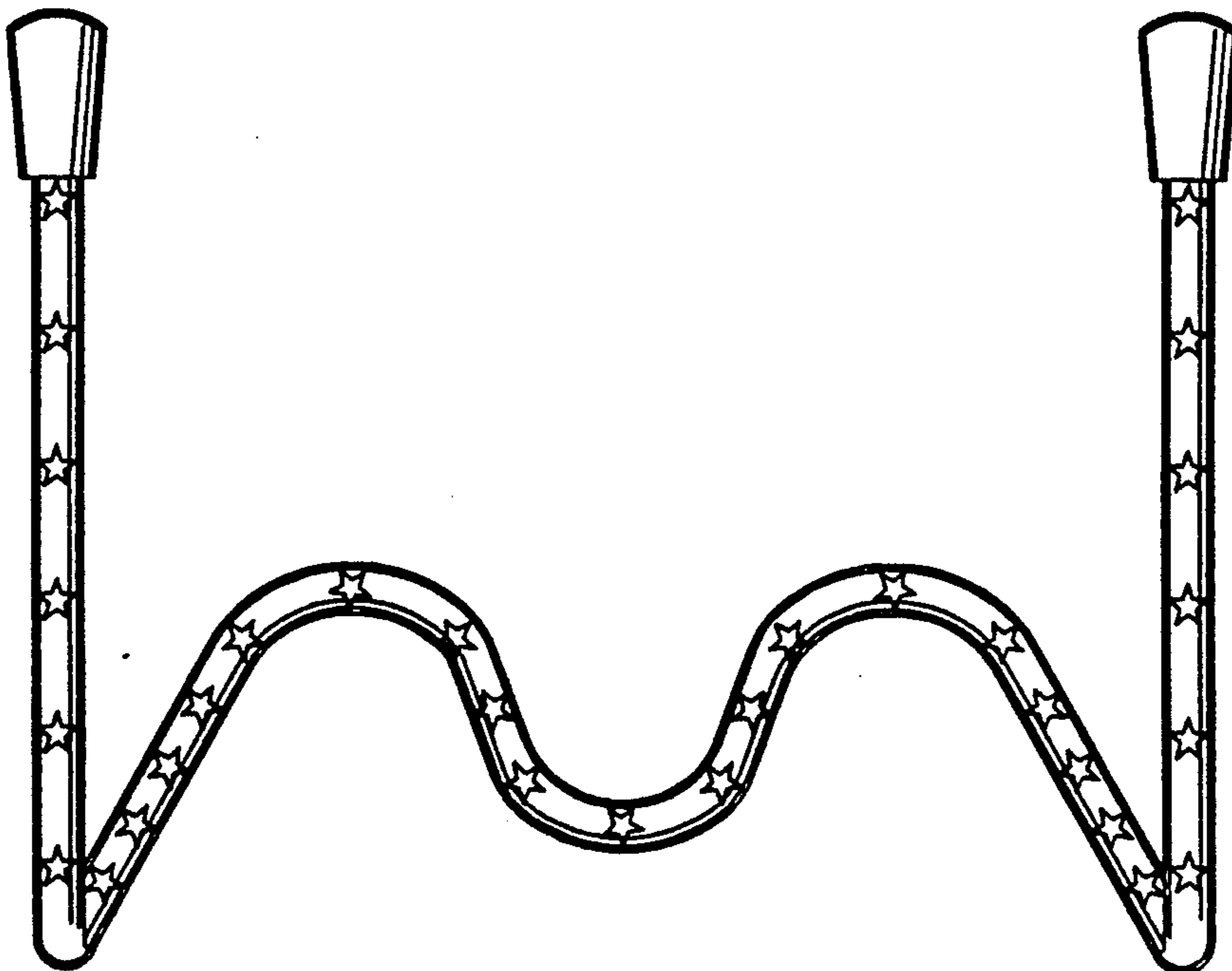

FIG. 7

