



US00D334452S

United States Patent [19]

[11] Patent Number: **Des. 334,452**

Duncan

[45] Date of Patent: **** Mar. 30, 1993**

[54] **AUTOMOBILE JACK ATTACHMENT**

[76] Inventor: **Stacy L. Duncan, Rte. 1, Box 313, Michigan City, Miss. 38647**

[**] Term: **14 Years**

[21] Appl. No.: **677,849**

[22] Filed: **Apr. 1, 1991**

[52] U.S. Cl. **D34/31**

[58] Field of Search **D34/31; 296/1.1; 7/100; 254/8 B, 89 R, 7 B, 103**

[56] **References Cited**

U.S. PATENT DOCUMENTS

1,107,833	8/1914	Parker	254/89 R
1,978,471	10/1934	Mizer et al.	254/89 R
2,012,430	8/1935	Kuhlman	254/89 R

Primary Examiner—Wallace R. Burke
Assistant Examiner—H. Baynham
Attorney, Agent, or Firm—Leon Gilden

[57] **CLAIM**

The ornamental design for an automobile jack attachment, as shown and described.

DESCRIPTION

FIG. 1 is a front elevational view of the automobile jack attachment showing my new design; FIG. 2 is a rear elevational view thereof; FIG. 3 is a left side elevational view thereof; FIG. 4 is a right side elevational view thereof; FIG. 5 is a top plan view thereof; FIG. 6 is a bottom plan view thereof; and, FIG. 7 is a perspective view thereof.

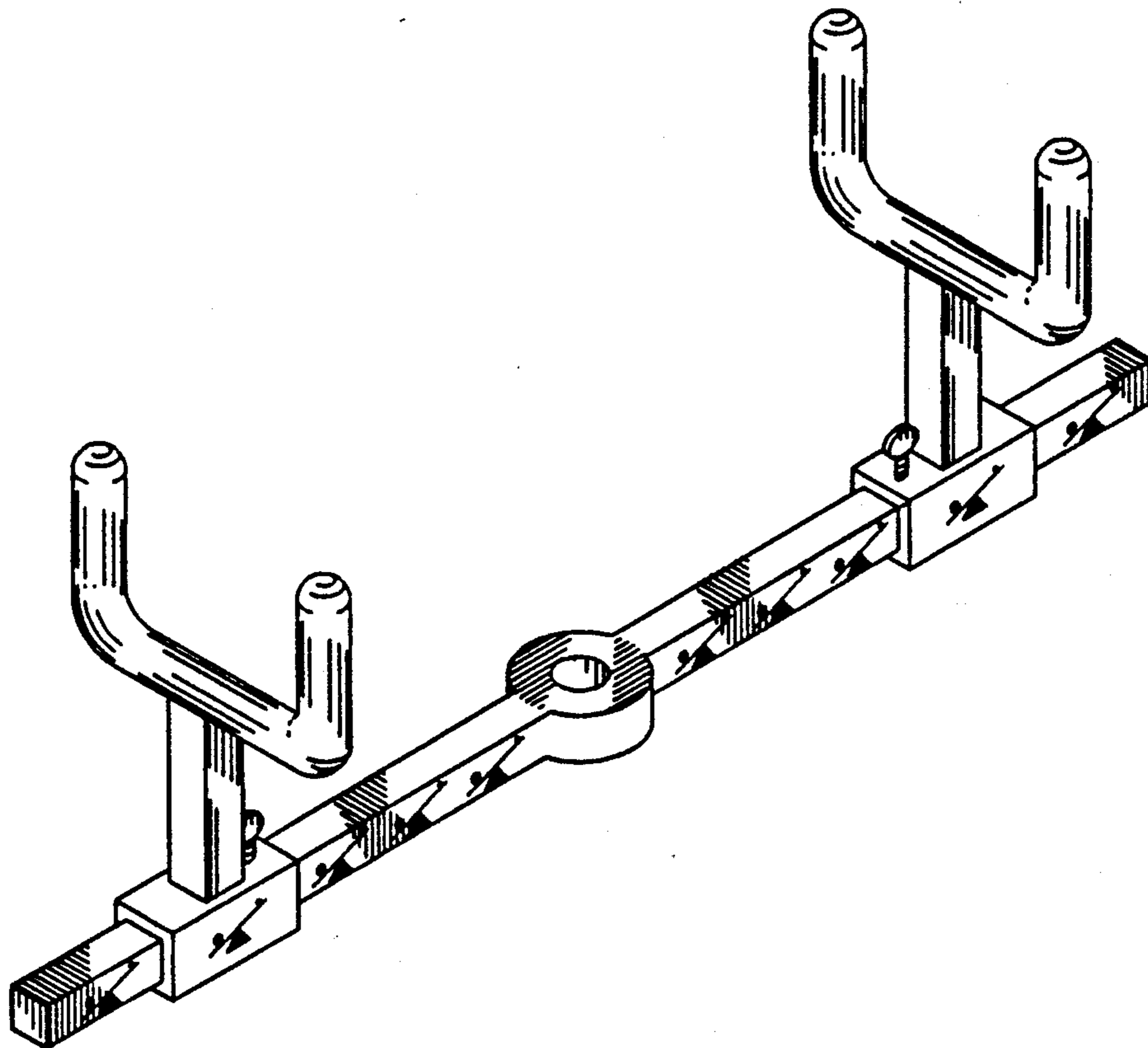

FIG. 1

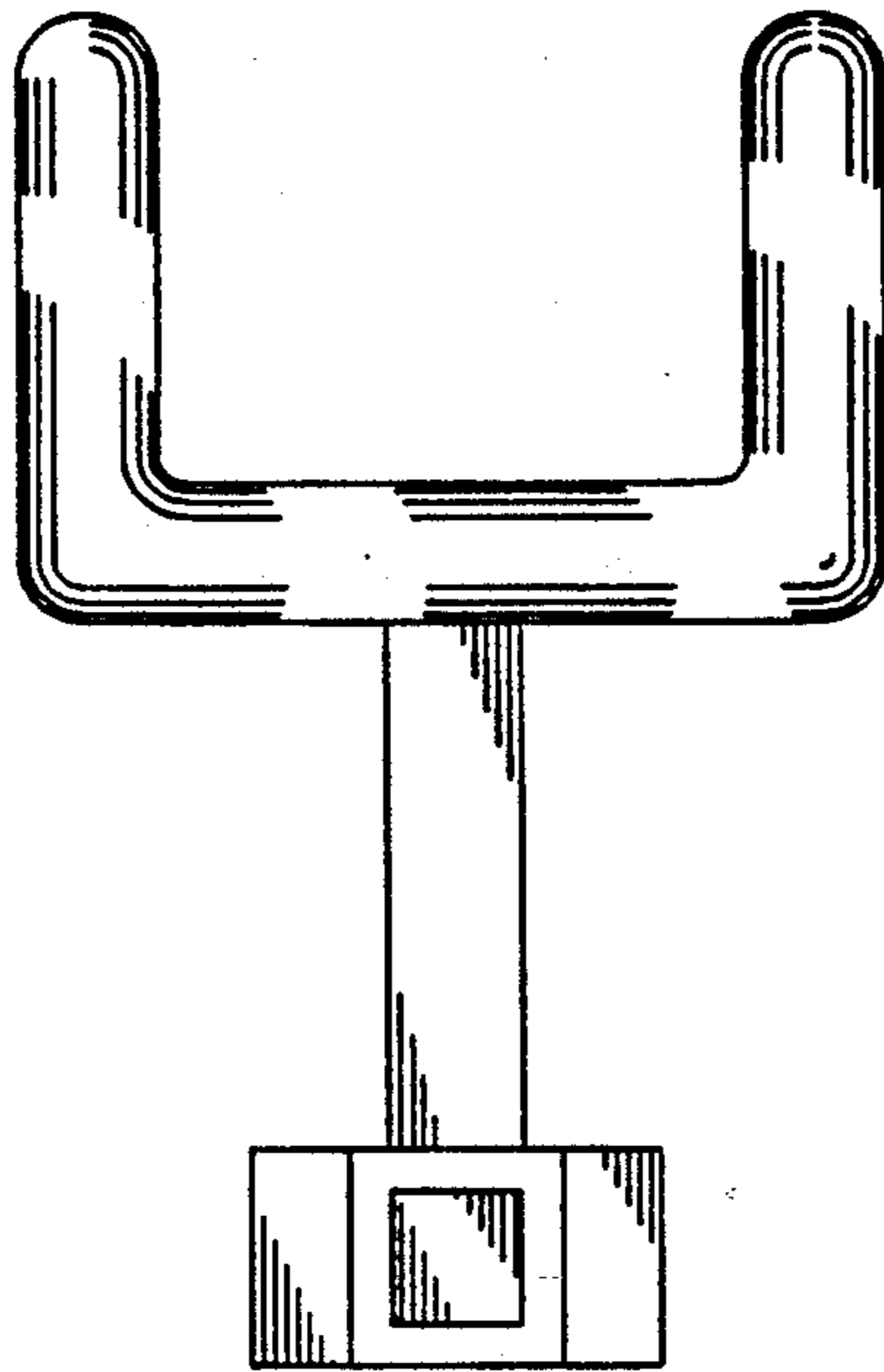

FIG. 2

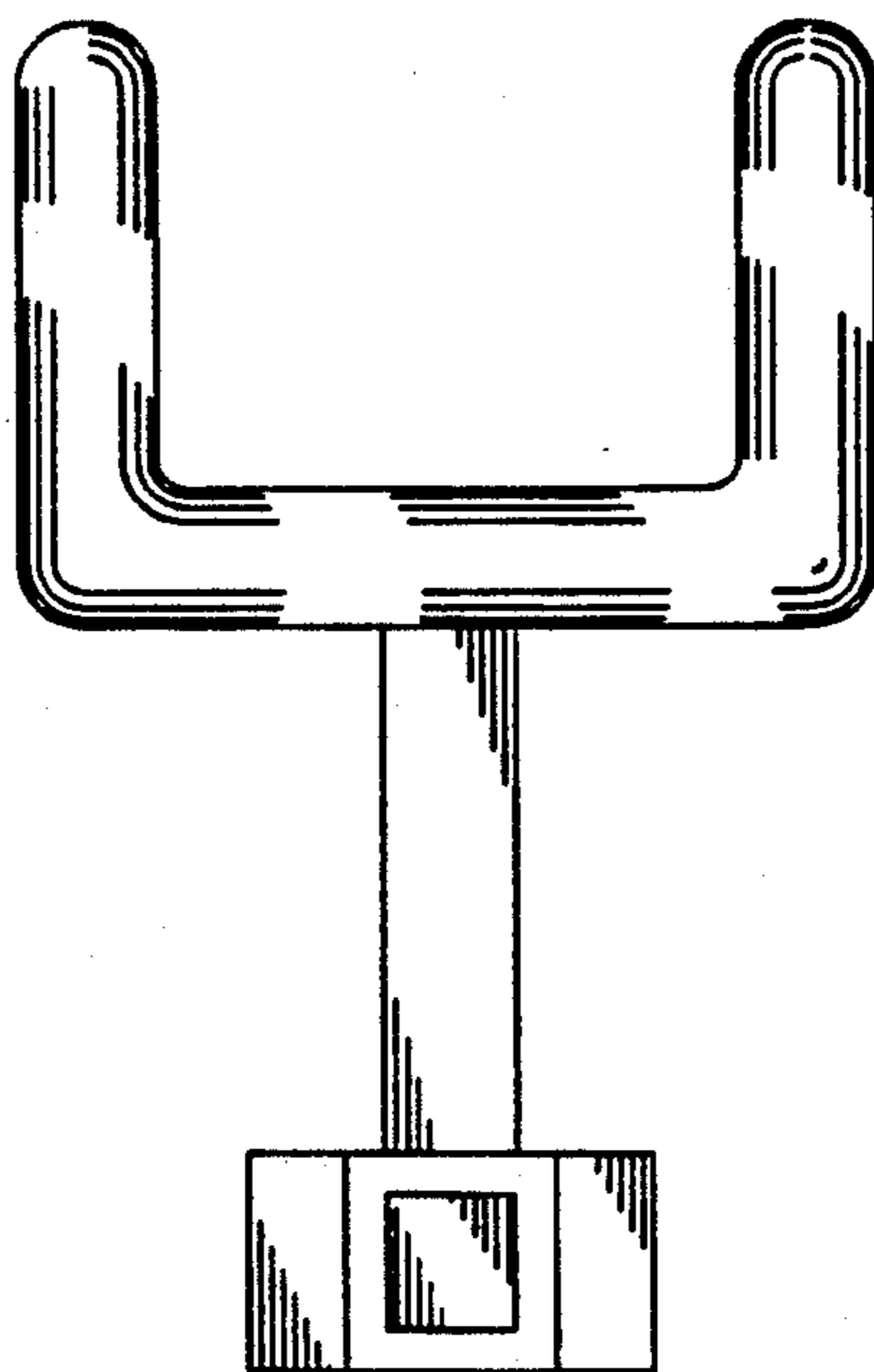

FIG. 3

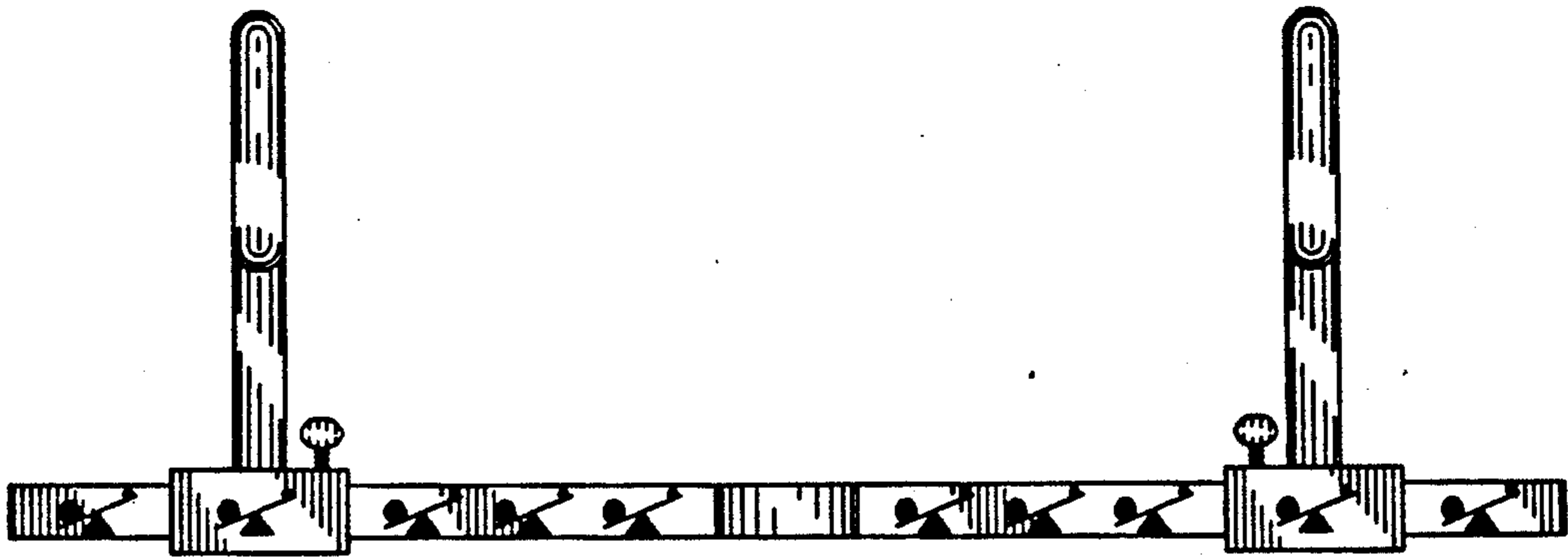

FIG. 4

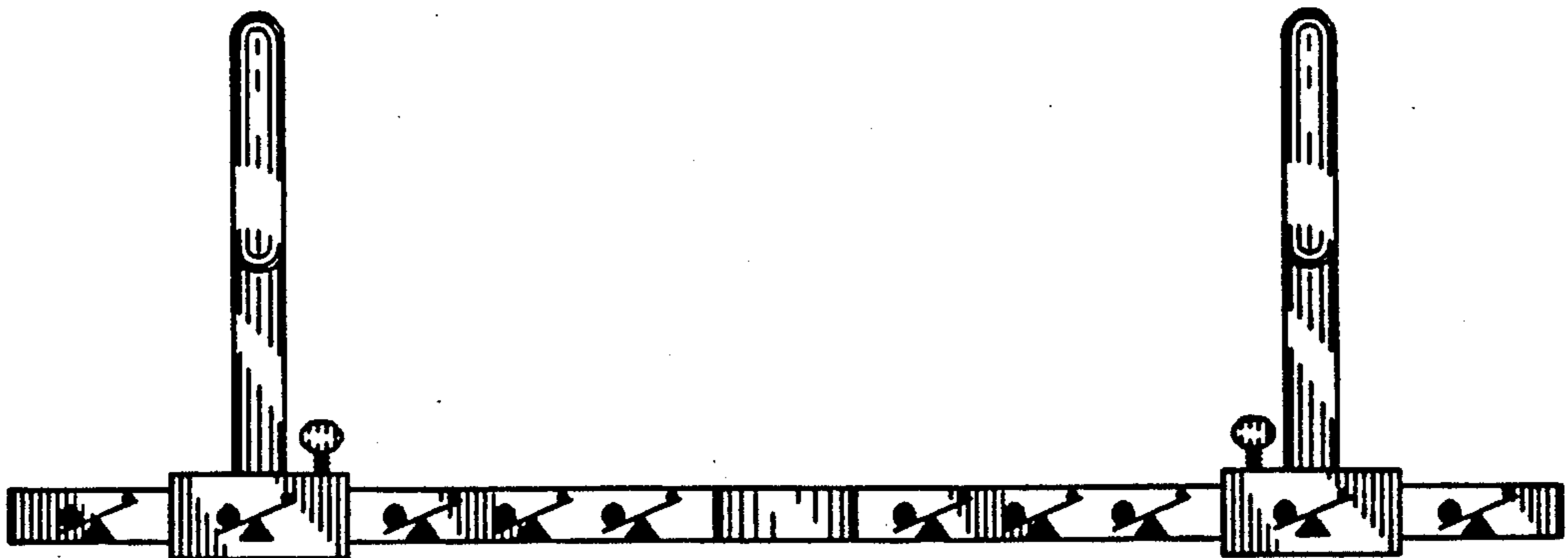

FIG. 5

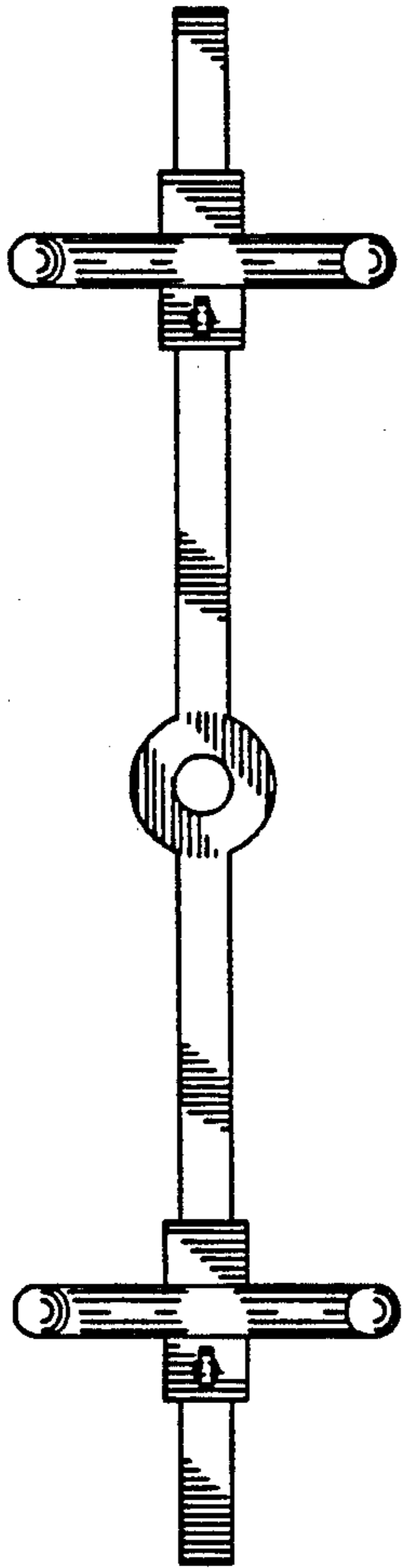

FIG. 6

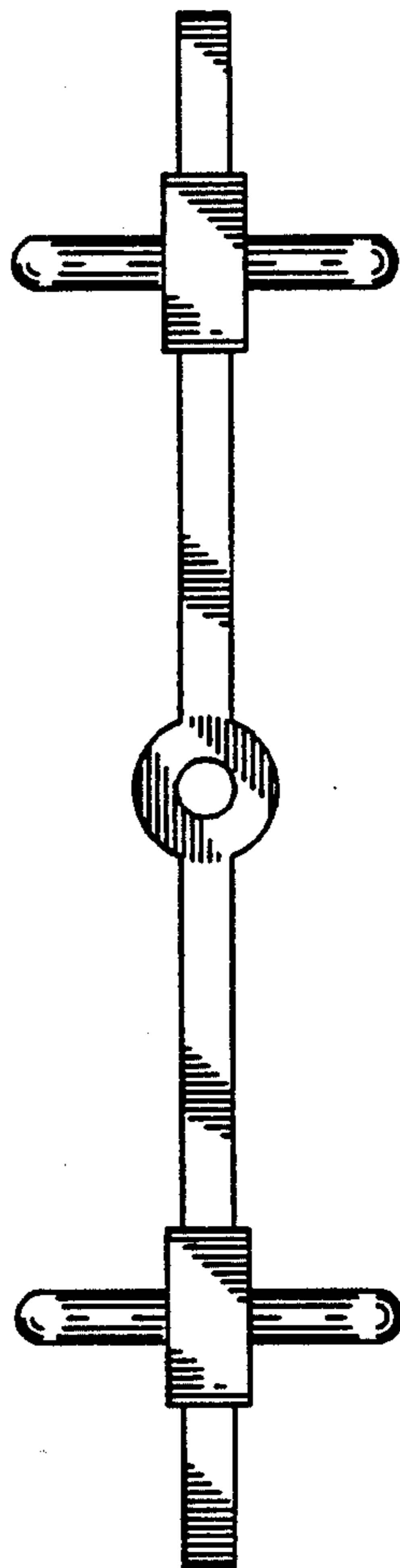

FIG. 7

